

REPAIR MANUAL

- MAINTENANCE
- PREPARATION
- SPECIFICATIONS
- DIAGNOSTICS

FOREWORD

This manual (Volume 1) contains maintenance, preparation, specifications and diagnostics procedures for the 2000 CELICA.

Applicable models: ZTZ230, 231 series

For repair procedures for the engine, chassis and body, and electrical service procedures, refer to VOLUME 2 (Pub. No. RM744U2).

The manual is divided into 6 sections with a thumb index for each section at the edge of the pages.

Please note that the publications below have also been prepared as relevant service manuals for the components and systems in this vehicles.

Manual Name	Pub. No.
• U240E Automatic Transaxle Repair Manual (Aug., 1999)	RM740U
• U340E, U341E Automatic Transaxle Repair Manual (Aug., 1999)	RM735U
• 2000 CELICA Electrical Wiring Diagram	EW0399U
• 2000 CELICA New Car Features	NCF169U

All information in this manual is based on the latest product information at the time of publication. However, specifications and procedures are subject to change without notice.

TOYOTA MOTOR CORPORATION

©1999 TOYOTA MOTOR CORPORATION

All rights reserved. This book may not be reproduced or copied, in whole or in part, without the written permission of Toyota Motor Corporation.

First Printing: Jul. 14, 1999 01-990714-00

CAUTION

This manual does not include all the necessary items about repair and service. This manual is made for the purpose of the use for the persons who have special techniques and certifications. In the cases that non-specialized or uncertified technicians perform repair or service only using this manual or without proper equipment or tool, that may cause severe injury to you or other people around and also cause damage to your customer's vehicle.

In order to prevent dangerous operation and damages to your customer's vehicle, be sure to follow the instruction shown below.

- **Must read this manual thoroughly. It is especially important to have good understanding all the contents written in the PRECAUTION of "IN" section.**
- **The service method written in this manual is very effective to perform repair and service. When performing the operations following the procedures using this manual, be sure to use tools specified and recommended. If using non-specified or recommended tools and service method, be sure to confirm safety of the technicians and any possibility of causing personal injury or damage to the customer's vehicle before starting the operation.**
- **If part replacement is necessary, must replace the part with the same part number or equivalent part. Do not replace it with inferior quality.**
- **It is important to note that this manual contains various "Cautions" and "Notices" that must be carefully observed in order to reduce the risk of personal injury during service or repair, or the possibility that improper service or repair may damage the vehicle or render it unsafe. It is also important to understand that these "Cautions" and "Notices" are not exhaustive, because it is important to warn of all the possible hazardous consequences that might result from failure to follow these instructions.**

NOTE: The screen toned sections below are in VOLUME 2
(Pub. No. RM744U2).

INTRODUCTION	IN
MAINTENANCE	MA
PREPARATION	PP
SERVICE SPECIFICATIONS	SS
DIAGNOSTICS	DI
ENGINE MECHANICAL	INTRO
EMISSION CONTROL	INTRO
SFI	INTRO
COOLING	INTRO
LUBRICATION	INTRO
IGNITION	INTRO
STARTING	INTRO
CHARGING	INTRO
CLUTCH	INTRO
C55 MANUAL TRANSAXLE	INTRO
C60 MANUAL TRANSAXLE	INTRO
U240E AUTOMATIC TRANSAXLE	INTRO
U341E AUTOMATIC TRANSAXLE	INTRO
SUSPENSION AND AXLE	INTRO
BRAKE	INTRO
STEERING	INTRO
SUPPLEMENTAL RESTRAINT SYSTEM	INTRO
BODY ELECTRICAL	INTRO
BODY	INTRO
AIR CONDITIONING	INTRO
ALPHABETICAL INDEX	ID

INTRODUCTION

HOW TO USE THIS MANUAL	IN-1
GENERAL INFORMATION	IN-1
IDENTIFICATION INFORMATION	IN-3
VEHICLE IDENTIFICATION AND ENGINE SERIAL NUMBER	IN-3
REPAIR INSTRUCTIONS	IN-4
GENERAL INFORMATION	IN-4
VEHICLE LIFT AND SUPPORT LOCATIONS ..	IN-8
FOR ALL OF VEHICLES	IN-10
PRECAUTION	IN-10
HOW TO TROUBLESHOOT ECU	
CONTROLLED SYSTEMS	IN-19
GENERAL INFORMATION	IN-19
HOW TO PROCEED WITH TROUBLESHOOTING	IN-20
HOW TO USE THE DIAGNOSTIC CHART AND INSPECTION PROCEDURE	IN-30
TERMS	IN-35
ABBREVIATIONS USED IN THIS MANUAL	IN-35
GLOSSARY OF SAE AND TOYOTA TERMS ...	IN-40

HOW TO USE THIS MANUAL

GENERAL INFORMATION

FIGURE 36

1. INDEX

An INDEX is provided on the first page of each section to guide you to the item to be repaired. To assist you in finding your way through the manual, the section title and major heading are given at the top of every page.

2. PRECAUTION

At the beginning of each section, a PRECAUTION is given that pertains to all repair operations contained in that section.

Read these precautions before starting any repair task.

3. TROUBLESHOOTING

TROUBLESHOOTING tables are included for each system to help you diagnose the problem and find the cause. The fundamentals of how to proceed with troubleshooting are described on page IN-20.

Be sure to read this before performing troubleshooting.

4. PREPARATION

Preparation lists the SST (Special Service Tools), recommended tools, equipment, lubricant and SSM (Special Service Materials) which should be prepared before beginning the operation and explains the purpose of each one.

5. REPAIR PROCEDURES

Most repair operations begin with an overview illustration. It identifies the components and shows how the parts fit together.

Example:

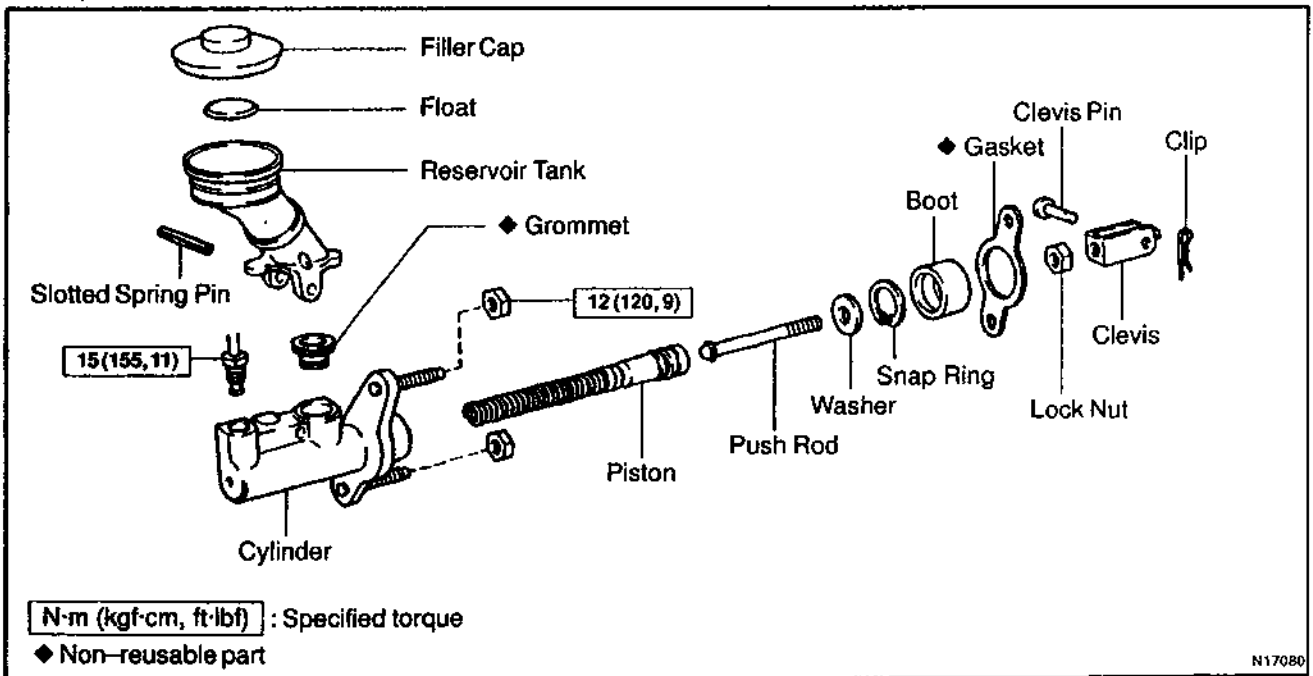

The procedures are presented in a step-by-step format:

- The illustration shows what to do and where to do it.
- The task heading tells what to do.
- The detailed text tells how to perform the task and gives other information such as specifications and warnings.

IN

Example:

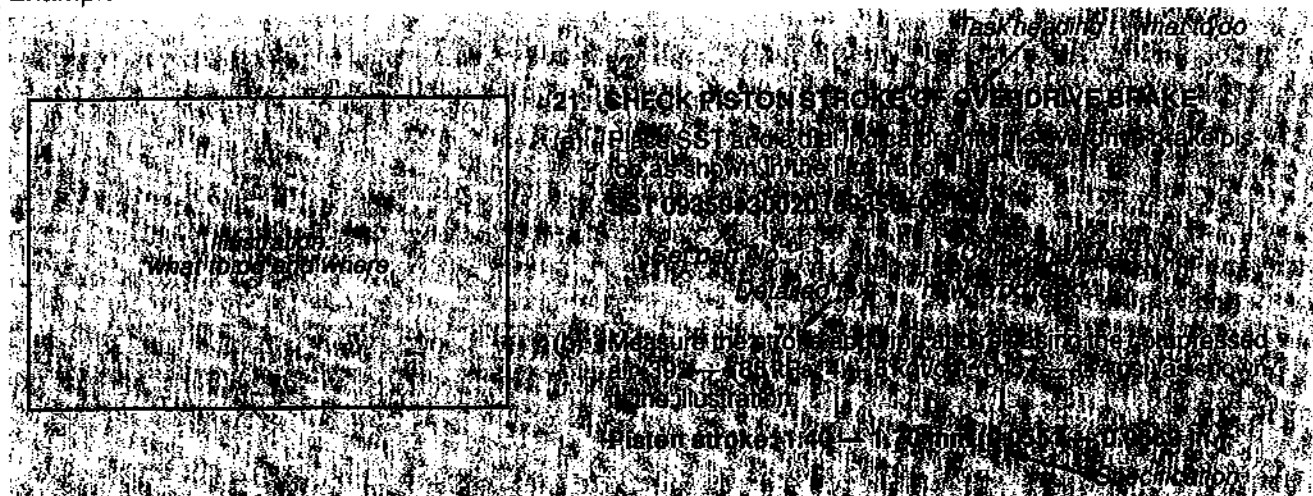

This format provides the experienced technician with a FAST TRACK to the information needed. The upper case task heading can be read at a glance when necessary, and the text below it provides detailed information. Important specifications and warnings always stand out in bold type.

6. REFERENCES

References have been kept to a minimum. However, when they are required you are given the page to refer to.

7. SPECIFICATIONS

Specifications are presented in bold type throughout the text where needed. You never have to leave the procedure to look up your specifications. They are also found in Service Specifications section for quick reference.

8. CAUTIONS, NOTICES, HINTS:

- CAUTIONS are presented in bold type, and indicate there is a possibility of injury to you or other people.
- NOTICES are also presented in bold type, and indicate the possibility of damage to the components being repaired.
- HINTS are separated from the text but do not appear in bold. They provide additional information to help you perform the repair efficiently.

9. SI UNIT

The UNITS given in this manual are primarily expressed according to the SI UNIT (International System of Unit), and alternately expressed in the metric system and in the English System.

Example:

Torque: 30 N·m (310 kgf·cm, 22 ft·lbf)

IDENTIFICATION INFORMATION

VEHICLE IDENTIFICATION AND ENGINE SERIAL NUMBER

INCH-01

IN

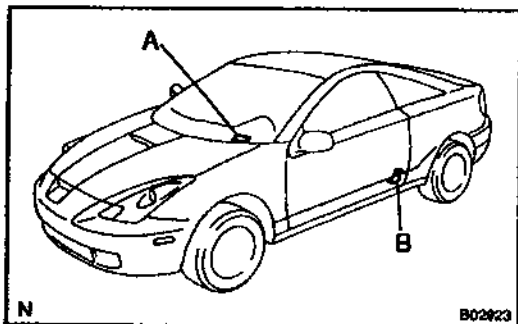

1. VEHICLE IDENTIFICATION NUMBER

The vehicle identification number is stamped on the vehicle identification number plate and the certification label, as shown in the illustration.

- A: Vehicle Identification Number Plate
- B: Certification Label

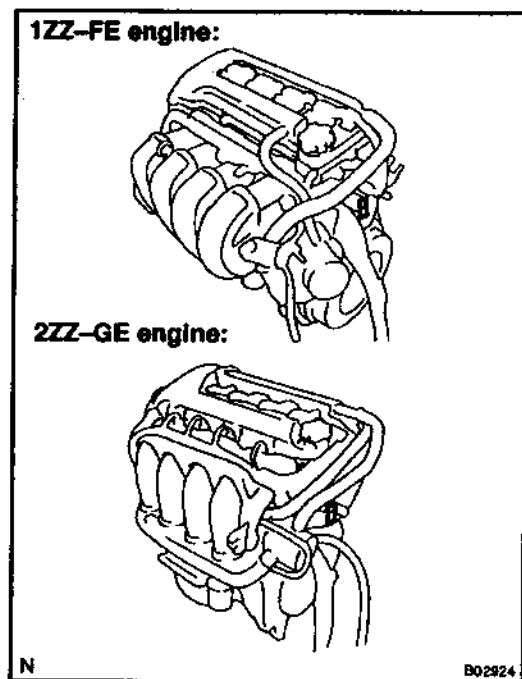

2. ENGINE SERIAL NUMBER

The engine serial number is stamped on the engine block, as shown in the illustration.

REPAIR INSTRUCTIONS

GENERAL INFORMATION

F800-08

BASIC REPAIR HINT

- (a) Use fender, seat and floor covers to keep the vehicle clean and prevent damage.
- (b) During disassembly, keep parts in the appropriate order to facilitate reassembly.
- (c) Installation and removal of battery terminal:
- (1) Before performing electrical work, disconnect the negative (-) terminal cable from the battery.
 - (2) If it is necessary to disconnect the battery for inspection or repair, first disconnect the negative (-) terminal cable.
 - (3) When disconnecting the terminal cable, to prevent damage to battery terminal, loosen the cable nut and raise the cable straight up without twisting or prying it.
 - (4) Clean the battery terminals and cable ends with a clean shop rag. Do not scrape them with a file or other abrasive objects.
 - (5) Install the cable ends to the battery terminals after loosening the nut, and tighten the nut after installation. Do not use a hammer to tap the cable ends onto the terminals.
 - (6) Be sure the cover for the positive (+) terminal is properly in place.
- (d) Check hose and wiring connectors to make sure that they are connected securely and correctly.
- (e) Non-reusable parts
- (1) Always replace cotter pins, gaskets, O-rings, oil seals, etc. with new ones.
 - (2) Non-reusable parts are indicated in the component illustrations by the "◆" symbol.

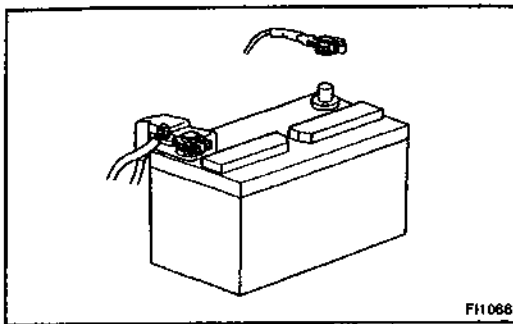

IN

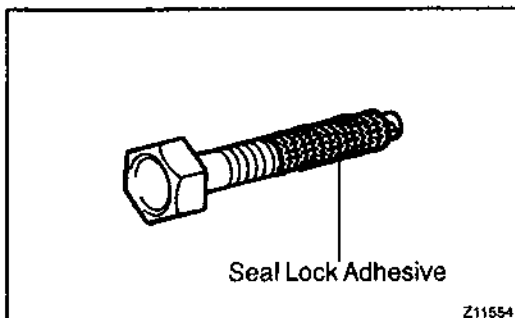

- (f) Precoated parts
Precoated parts are bolts, nuts, etc. that are coated with a seal lock adhesive at the factory.
- (1) If a precoated part is retightened, loosened or caused to move in any way, it must be recoated with the specified adhesive.
 - (2) When reusing precoated parts, clean off the old adhesive and dry with compressed air. Then apply the specified seal lock adhesive to the bolt, nut or threads.

- (3) Precoated parts are indicated in the component illustrations by the "★" symbol.
- (g) When necessary, use a sealer on gaskets to prevent leaks.
- (h) Carefully observe all specifications for bolt tightening torques. Always use a torque wrench.
- (i) Use of special service tools (SST) and special service materials (SSM) may be required, depending on the nature of the repair. Be sure to use SST and SSM where specified and follow the proper work procedure. A list of SST and SSM can be found in Preparation section in this manual.

IN

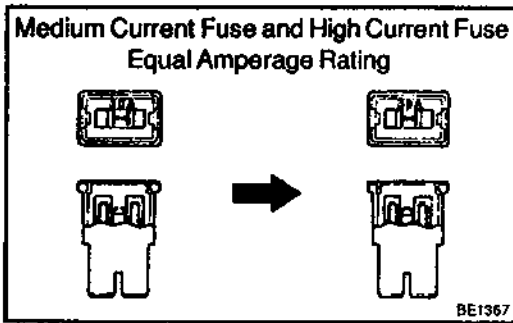

- (j) When replacing fuses, be sure the new fuse has the correct amperage rating. DO NOT exceed the rating or use one with a lower rating.

Illustration	Symbol	Part Name	Abbreviation
 BE5584	 IN0365	FUSE	FUSE
 BE5588	 IN0366	MEDIUM CURRENT FUSE	M-FUSE
 BE5596	 IN0367	HIGH CURRENT FUSE	H-FUSE
 BE5597	 IN0367	FUSIBLE LINK	FL
 BE5598	 IN0368	CIRCUIT BREAKER	CB

- (k) Care must be taken when jacking up and supporting the vehicle. Be sure to lift and support the vehicle at the proper locations (See page IN-8).
- Cancel the parking brake on the level place and shift the transmission in Neutral (or N position).
 - When jacking up the front wheels of the vehicle at first place stoppers behind the rear wheels.
 - When jacking up the rear wheels of the vehicle at first place stoppers before the front wheels.
 - When either the front or rear wheels only should be jacked up, set rigid racks and place stoppers in front and behind the other wheels on the ground.
 - After the vehicle is jacked up, be sure to support it on rigid racks . It is extremely dangerous to do any work on a vehicle raised on a jack alone, even for a small job that can be finished quickly.
- (l) Observe the following precautions to avoid damage to the following parts:
- (1) Do not open the cover or case of the ECU unless absolutely necessary. (If the IC terminals are touched, the IC may be destroyed by static electricity.)

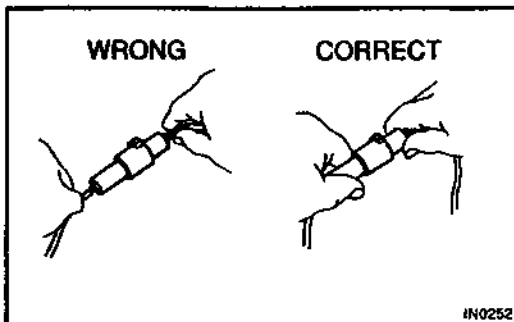
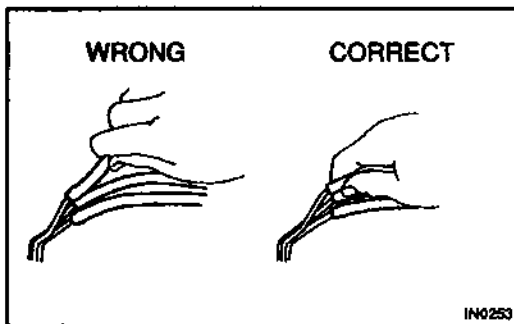

- (2) To disconnect vacuum hoses, pull off the end, not the middle of the hose.
- (3) To pull apart electrical connectors, pull on the connector itself, not the wires.
- (4) Be careful not to drop electrical components, such as sensors or relays. If they are dropped on a hard floor, they should be replaced and not reused.
- (5) When steam cleaning an engine, protect the electronic components, air filter and emission-related components from water.
- (6) Never use an impact wrench to remove or install temperature switches or temperature sensors.
- (7) When checking continuity at the wire connector, insert the tester probe carefully to prevent terminals from bending.
- (8) When using a vacuum gauge, never force the hose onto a connector that is too large. Use a step-down adapter for adjustment. Once the hose has been stretched, it may leak air.

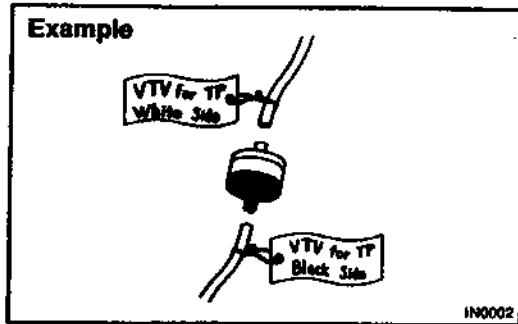

- (m) Installation and removal of vacuum hose:
- (1) When disconnecting vacuum hoses, use tags to identify how they should be reconnected to.
 - (2) After completing a job, double check that the vacuum hoses are properly connected. A label under the hood shows the proper layout.
- (n) Unless otherwise stated, all resistance is measured at an ambient temperature of 20°C (68°F). Because the resistance may be outside specifications if measured at high temperatures immediately after the vehicle has been running, measurement should be made when the engine has cooled down.

VEHICLE LIFT AND SUPPORT LOCATIONS

IN

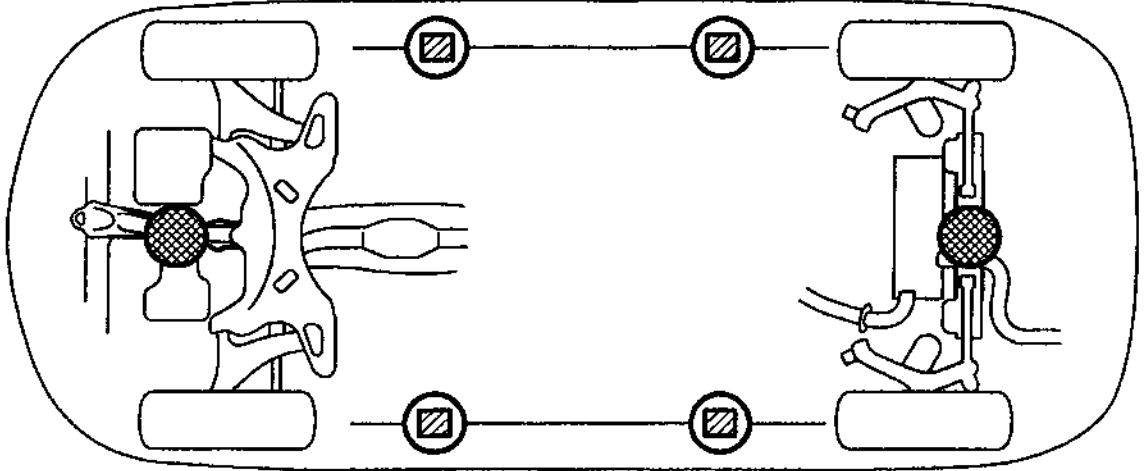

← Front

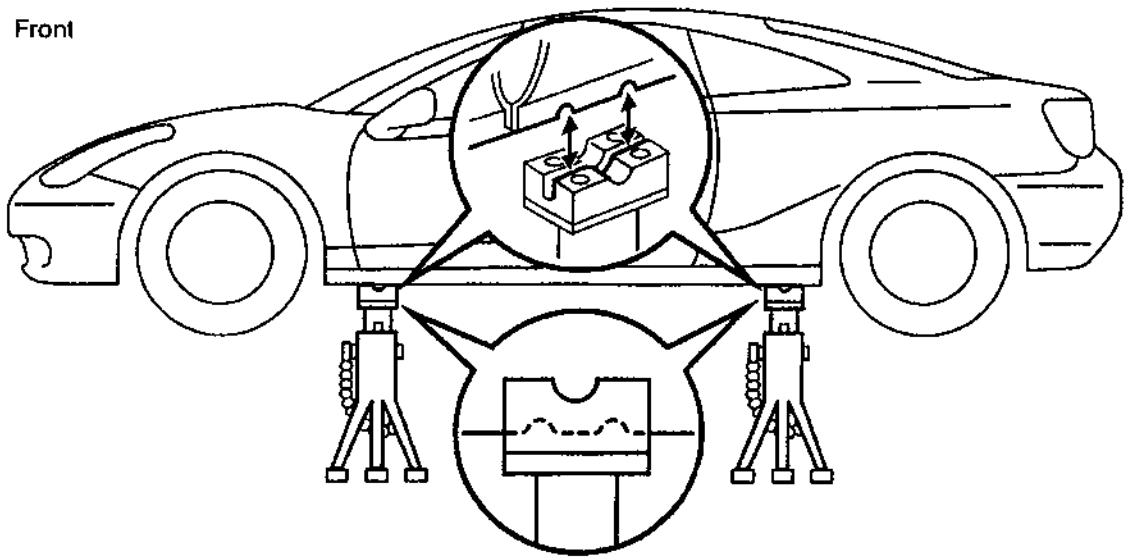

JACK POSITION _____ ●

Front Front crossmember

Rear Rear axle beam

CAUTION : When jacking-up the rear and front, make sure the car is not carrying any extra weight.

PANTOGRAPH JACK POSITION _____ ○

SUPPORT POSITION

Safety stand and swing arm type lift ▨

PLATE TYPE LIFT

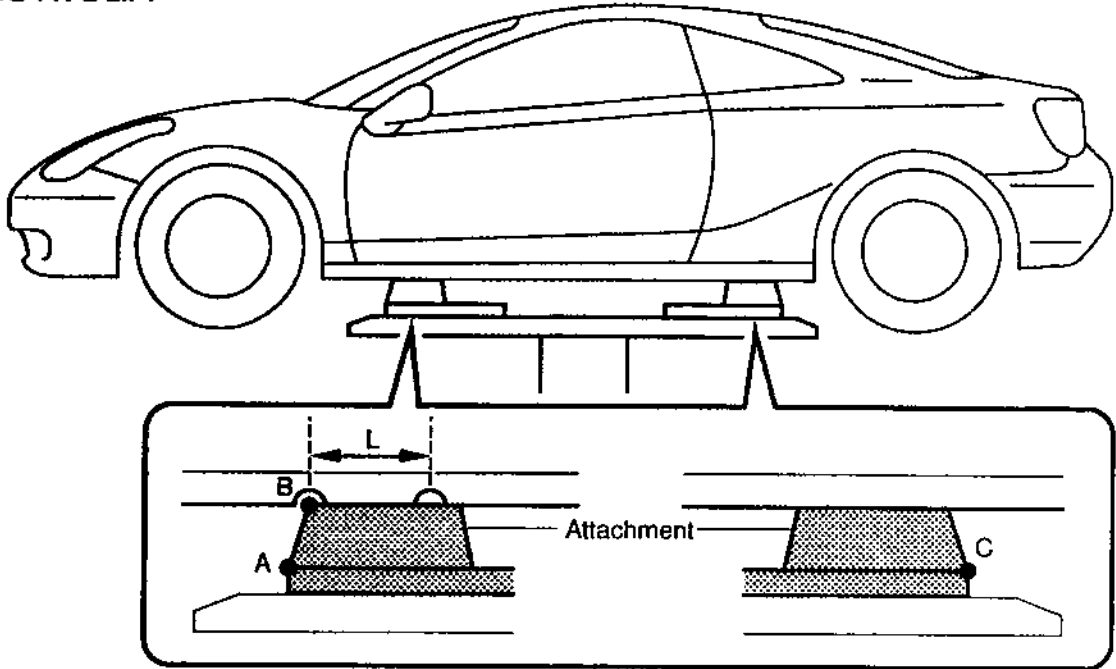

IN

HINT :

- Left and right set position
- Front and rear set position

Place the vehicle over the center of the lift.

- Align the cushion gum ends of the plate with the attachment lower ends (A, C).
- Align the attachment upper end (B) with the front jack supporting point (L).

Attachment dimensions

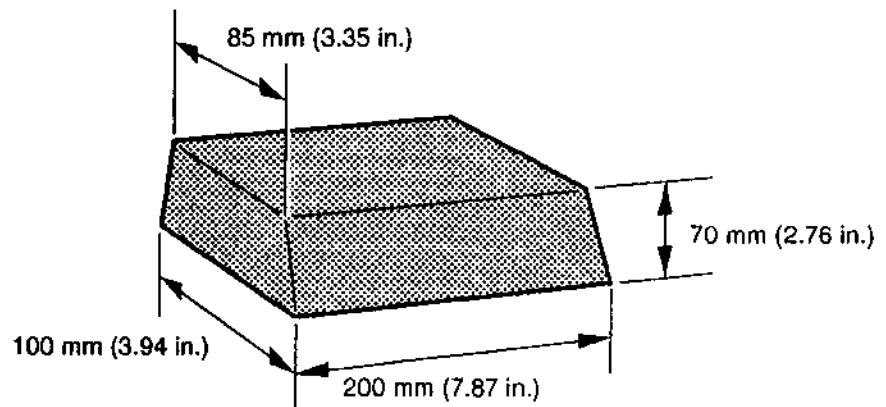

FOR ALL OF VEHICLES PRECAUTION

NFA-01

IN

1. FOR VEHICLES EQUIPPED WITH SRS AIRBAG AND SEAT BELT PRETENSIONER

- (a) The CELICA is equipped with an SRS (Supplemental Restraint System), such as the driver airbag, front passenger airbag assembly, side airbag assembly and seat belt pretensioner.

Failure to carry out service operations in the correct sequence could cause the supplemental restraint system to unexpectedly deploy during servicing, possibly leading to a serious accident.

Further, if a mistake is made in servicing the supplemental restraint system, it is possible the SRS may fail to operate when required. Before servicing (including removal or installation of parts, inspection or replacement), be sure to read the following items carefully, then follow the correct procedure described in this manual.

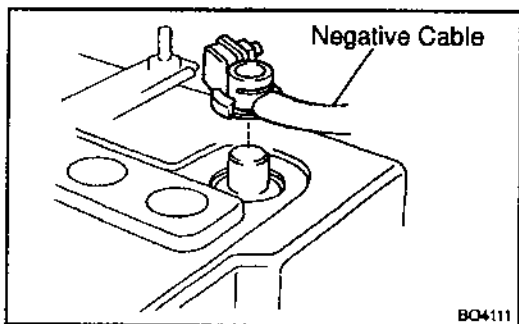

BQ4111

(b) GENERAL NOTICE

- (1) Malfunction symptoms of the supplemental restraint system are difficult to confirm, so the diagnostic trouble codes become the most important source of information when troubleshooting. When troubleshooting the supplemental restraint system, always inspect the diagnostic trouble codes before disconnecting the battery (See page DI-326).

- (2) Work must be started after 90 seconds from the time the ignition switch is turned to the "LOCK" position and the negative (-) terminal cable is disconnected from the battery.

(The supplemental restraint system is equipped with a back-up power source so that if work is started within 90 seconds of disconnecting the negative (-) terminal cable from the battery, the SRS may deploy.)

When the negative (-) terminal cable is disconnected from the battery, memory of the clock and audio systems will be cancelled. So before starting work, make a record of the contents memorized by the each memory system. Then when work is finished, reset the clock and audio systems as before. To avoid erasing the memory of each memory system, never use a back-up power supply from another battery.

- (3) Even in cases of a minor collision where the SRS does not deploy, the steering wheel pad, front passenger airbag assembly, side airbag assembly and seat belt pretensioner should be inspected (See page RS-14, RS-28, and BO-111).
- (4) Never use SRS parts from another vehicle. When replacing parts, replace them with new parts.
- (5) Before repairs, remove the airbag sensor if shocks are likely to be applied to the sensor during repairs.
- (6) Never disassemble and repair the airbag sensor assembly, steering wheel pad, front passenger airbag assembly, side airbag assembly or seat belt pretensioner.
- (7) If the airbag sensor assembly, steering wheel pad, front passenger airbag assembly, side airbag assembly or seat belt pretensioner has been dropped, or if there are cracks, dents or other defects in the case, bracket or connector, replace them with new ones.
- (8) Do not directly expose the airbag sensor assembly, steering wheel pad, front passenger airbag assembly, side airbag assembly or seat belt pretensioner to hot air or flames.
- (9) Use a volt/ohmmeter with high impedance (10 k Ω /V minimum) for troubleshooting of the electrical circuit.
- (10) Information labels are attached to the periphery of the SRS components. Follow the instructions on the notices.
- (11) After work on the supplemental restraint system is completed, check the SRS warning light (See page DI-326).

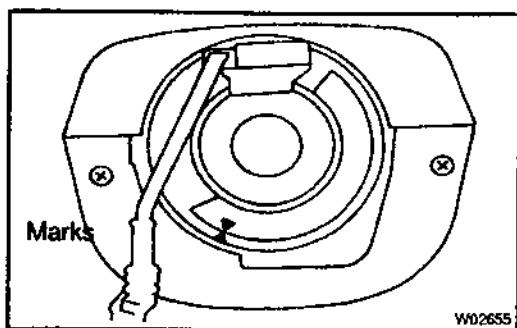

- (c) **SPIRAL CABLE** (in Combination Switch)
The steering wheel must be fitted correctly to the steering column with the spiral cable at the neutral position, otherwise cable disconnection and other troubles may result. Refer to SR-19 of this manual concerning correct steering wheel installation.

(d) STEERING WHEEL PAD (with Airbag)

- (1) When removing the steering wheel pad or handling a new steering wheel pad, it should be placed with the pad top surface facing up.
Storing the pad with its metallic surface facing upward may lead to a serious accident if the airbag deploys for some reason. In addition do not store a steering wheel pad on top of another one.
- (2) Never measure the resistance of the airbag squib. (This may cause the airbag to deploy, which is very dangerous.)
- (3) Grease should not be applied to the steering wheel pad and the pad should not be cleaned with detergents of any kind.
- (4) Store the steering wheel pad where the ambient temperature remains below 93°C (200°F), without high humidity and away from electrical noise.
- (5) When using electric welding, first disconnect the airbag connector (yellow color and 2 pins) under the steering column near the combination switch connector before starting work.
- (6) When disposing of a vehicle or the steering wheel pad alone, the airbag should be deployed using an SST before disposal (See page RS-16).
Carry out the operation in a safe place away from electrical noise.

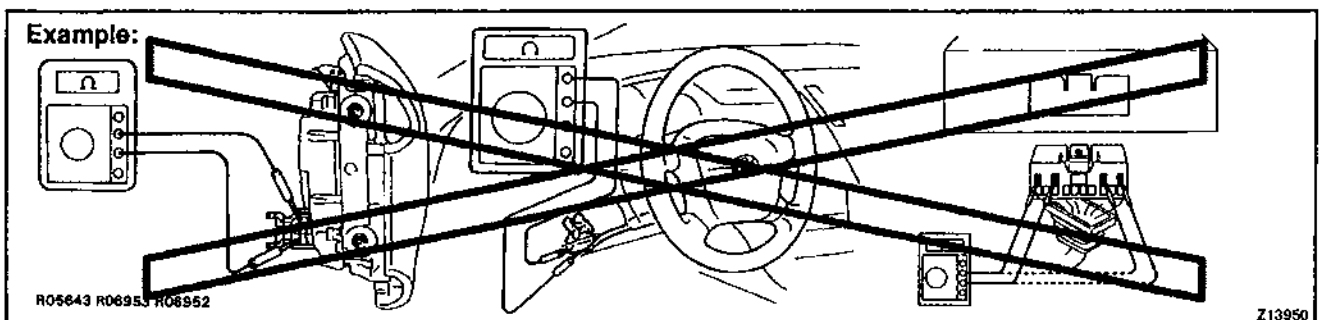
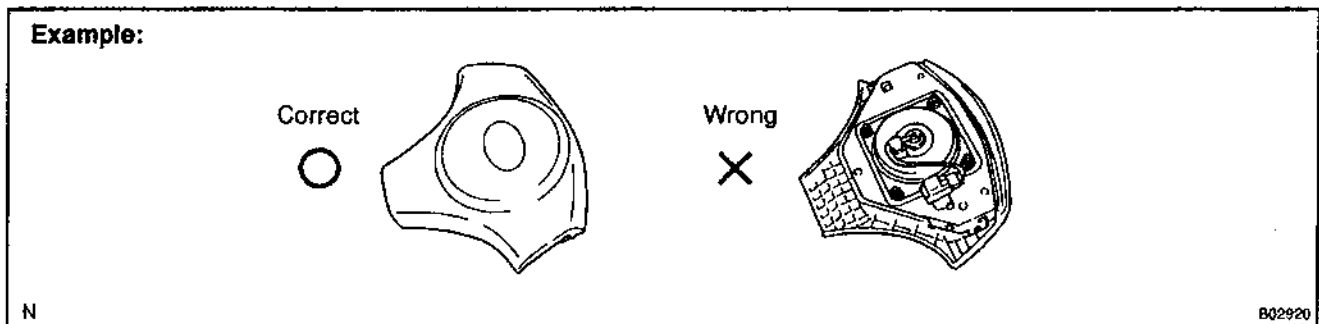

(e) FRONT PASSENGER AIRBAG ASSEMBLY

- (1) Always store a removed or new front passenger airbag assembly with the airbag deployment direction facing up.
Storing the airbag assembly with the airbag deployment direction facing down could cause a serious accident if the airbag inflates.
- (2) Never measure the resistance of the airbag squib. (This may cause the airbag to deploy, which is very dangerous.)
- (3) Grease should not be applied to the front passenger airbag assembly and the airbag door should not be cleaned with detergents of any kind.
- (4) Store the airbag assembly where the ambient temperature remains below 93°C (200°F), without high humidity and away from electrical noise.
- (5) When using electric welding, first disconnect the airbag connector (yellow color and 2 pins) installed on the assembly before starting work.
- (6) When disposing of a vehicle or the airbag assembly alone, the airbag should be deployed using an SST before disposal (See page RS-30).
Perform the operation in a safe place away from electrical noise.

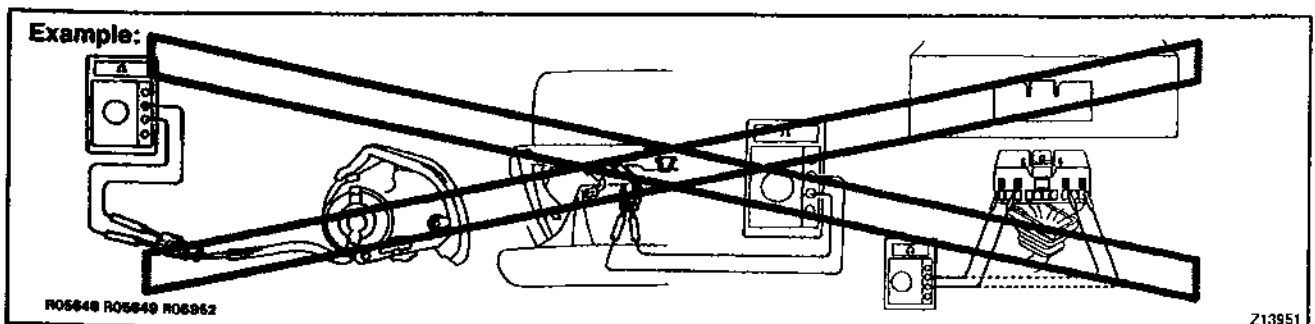
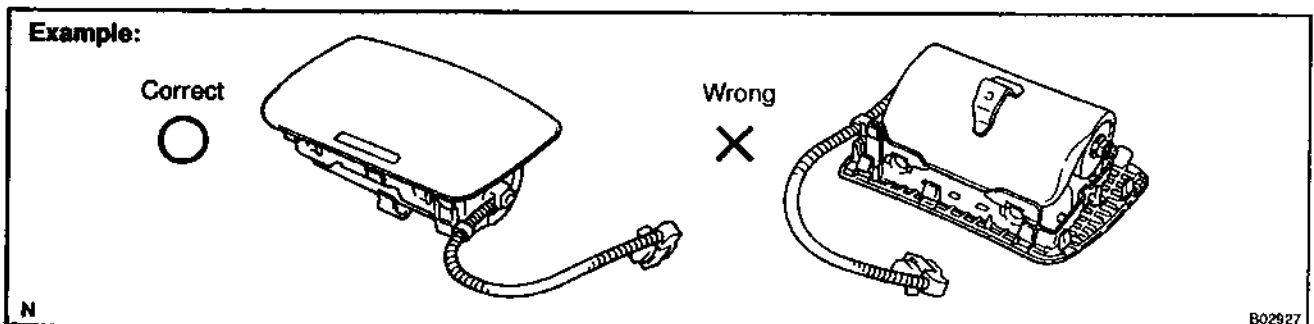

(f) SIDE AIRBAG ASSEMBLY

- (1) Always store a removed or new side airbag assembly with the airbag deployment direction facing up. Storing the airbag assembly with the airbag deployment direction facing down could cause a serious accident if the airbag deploys.
- (2) Never measure the resistance of the airbag squib. (This may cause the airbag to deploy, which is very dangerous.)
- (3) Grease should not be applied to the side airbag assembly and the surface should not be cleaned with detergents of any kind.
- (4) Store the airbag assembly where the ambient temperature remains below 93°C (200°F), without high humidity and away from electrical noise.
- (5) When using electric welding, first disconnect the airbag connector (yellow color and 2 pins) under the seat before starting work.
- (6) When disposing of a vehicle or the side airbag assembly alone, the airbag should be deployed using an SST before disposal (See page RS-43). Perform the operation in a safe place away from electrical noise.

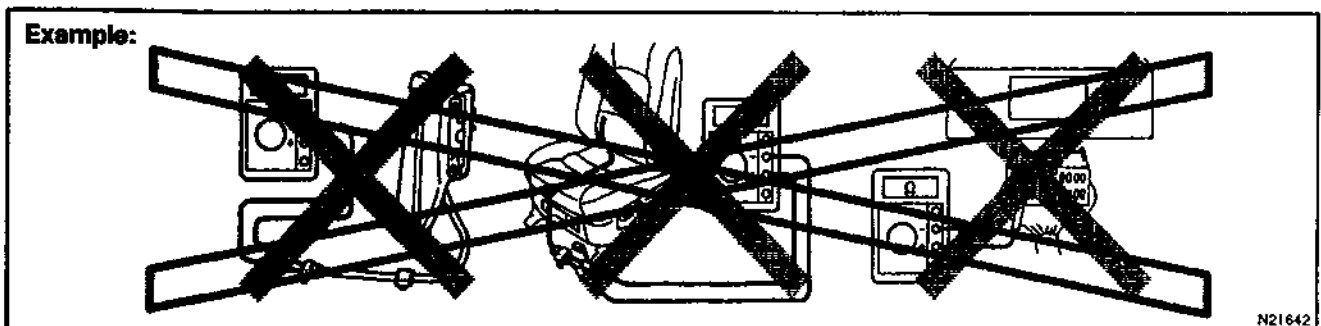
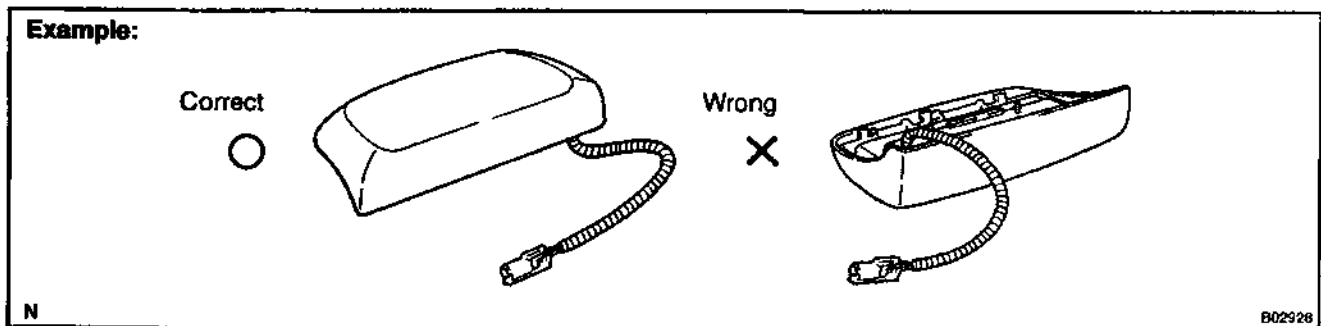

(g) SEAT BELT PRETENSIONER

- (1) Never measure the resistance of the seat belt pretensioner. (This may cause the seat belt pretensioner to activate, which is very dangerous.)
- (2) Never disassemble the seat belt pretensioner.
- (3) Never install the seat belt pretensioner in another vehicle.
- (4) Store the seat belt pretensioner where the ambient temperature remains below 80°C (176°F) and away from electrical noise without high humidity.
- (5) When using electric welding, first disconnect the connector (yellow color and 2 pins) before starting work.
- (6) When disposing of a vehicle or the seat belt pretensioner alone, the seat belt pretensioner should be activated before disposal (See page BO-112). Perform the operation in a safe place away from electrical noise.
- (7) The seat belt pretensioner is hot after activation, so let it cool down sufficiently before the disposal. However never apply water to the seat belt pretensioner.

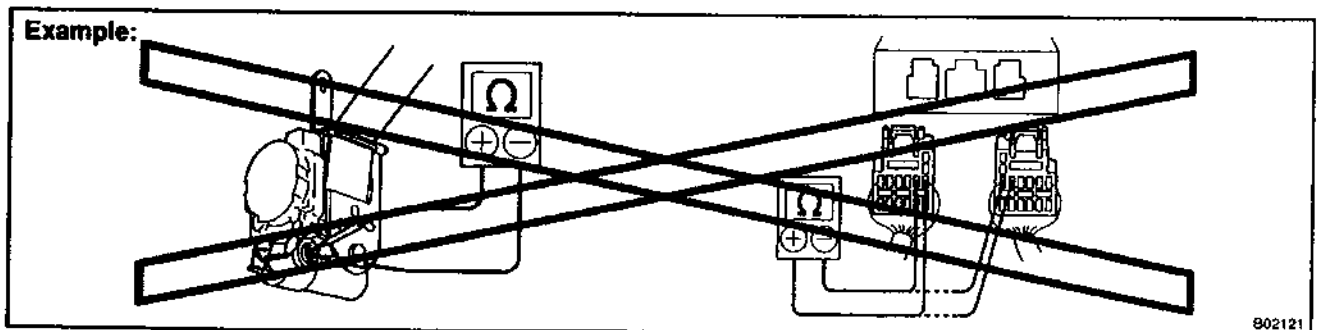

(h) AIRBAG SENSOR ASSEMBLY

- (1) Never reuse the airbag sensor assembly involved in a collision when the SRS has deployed.
- (2) The connectors to the airbag sensor assembly should be connected or disconnected with the sensor mounted on the floor. If the connectors are connected or disconnected while the airbag sensor assembly is not mounted to the floor, it could cause undesired ignition of the supplemental restraint system.
- (3) Work must be started after 90 seconds from the time the ignition switch is turned to the "LOCK" position and the negative (-) terminal cable is disconnected from the battery, even if only loosening the set bolts of the airbag sensor assembly.

(i) WIRE HARNESS AND CONNECTOR

The SRS wire harness is integrated with the instrument panel wire harness assembly. All the connectors in the system are a standard yellow color. If the SRS wire harness becomes disconnected or the connector becomes broken due to an accident, etc., repair or replace it as shown on page RS-72.

2. FOR VEHICLES EQUIPPED WITH A CATALYTIC CONVERTER**CAUTION:**

If large amount of unburned gasoline flows into the converter, it may overheat and create a fire hazard. To prevent this, observe the following precautions and explain them to your customer.

- (a) Use only unleaded gasoline.
- (b) Avoid prolonged idling.
Avoid running the engine at idle speed for more than 20 minutes.
- (c) Avoid spark jump test.
 - (1) Perform spark jump test only when absolutely necessary. Perform this test as rapidly as possible.
 - (2) While testing, never race the engine.
- (d) Avoid prolonged engine compression measurement.
Engine compression tests must be done as rapidly as possible.
- (e) Do not run engine when fuel tank is nearly empty.
This may cause the engine to misfire and create an extra load on the converter.
- (f) Avoid coasting with ignition turned off.
- (g) Do not dispose of used catalyst along with parts contaminated with gasoline or oil.

3. IF VEHICLE IS EQUIPPED WITH MOBILE COMMUNICATION SYSTEM

For vehicles with mobile communication systems such as two-way radios and cellular telephones, observe the following precautions.

- (1) Install the antenna as far as possible away from the ECU and sensors of the vehicle's electronic system.
- (2) Install the antenna feeder at least 20 cm (7.87 in.) away from the ECU and sensors of the vehicle's electronic systems. For details about ECU and sensors locations, refer to the section on the applicable component.
- (3) Avoid winding the antenna feeder together with other wiring as much as possible, and also avoid running the antenna feeder parallel with other wire harnesses.
- (4) Check that the antenna and feeder are correctly adjusted.
- (5) Do not install powerful mobile communications system.

4. FOR USING OBD II SCAN TOOL OR TOYOTA HAND-HELD TESTER**CAUTION:**

Observe the following items for safety reasons:

- Before using the OBD II scan tool or TOYOTA hand-held tester, the OBD II scan tool's instruction book or TOYOTA hand-held tester's operator manual should be read thoroughly.
- Be sure to route all cables securely when driving with the OBD II scan tool or TOYOTA hand-held tester connected to the vehicle. (i.e. Keep cables away from feet, pedals, steering wheel and shift lever.)
- Two persons are required when test driving with the OBD II scan tool or TOYOTA hand-held tester, one person to drive the vehicle and the other person to operate the OBD II scan tool or TOYOTA hand-held tester.

HOW TO TROUBLESHOOT ECU CONTROLLED SYSTEMS

GENERAL INFORMATION

A large number of ECU controlled systems are used in the CELICA. In general, the ECU controlled system is considered to be a very intricate system requiring a high level of technical knowledge and expert skill to troubleshoot. However, the fact is that if you proceed to inspect the circuits one by one, troubleshooting of these systems is not complex. If you have adequate understanding of the system and a basic knowledge of electricity, accurate diagnosis and necessary repair can be performed to locate and fix the problem. This manual is designed through emphasis of the above standpoint to help service technicians perform accurate and effective troubleshooting, and is compiled for the following major ECU controlled systems:

The troubleshooting procedure and how to make use of it are described on the following pages.

System	Page
1. Engine	DI-1
2. U240E Automatic Transaxle	DI-155
3. U341E Automatic Transaxle	DI-218
4. Anti-Lock Brake System with Electronic Brake Force Distribution (EBD)	DI-274
5. Supplemental Restraint System	DI-324
6. Cruise Control System	DI-483
7. Body Control system	DI-535

FOR USING OBD II SCAN TOOL OR TOYOTA HAND-HELD TESTER

- Before using the scan tool or tester, the scan tool's instruction book or tester's operator manual should be read thoroughly.
- If the scan tool or tester cannot communicate with ECU controlled systems when you have connected the cable of the scan tool or tester to DLC3, turned the ignition switch ON and operated the scan tool, there is a problem on the vehicle side or tool side.
 - (1) If communication is normal when the tool is connected to another vehicle, inspect the diagnosis data link line (Bus \oplus line) or ECU power circuit of the vehicle.
 - (2) If communication is still not possible when the tool is connected to another vehicle, the problem is probably in the tool itself, so perform the Self Test procedures outline in the Tester Operator's Manual.

HOW TO PROCEED WITH TROUBLESHOOTING

Carry out troubleshooting in accordance with the procedure on the following page. Here, only the basic procedure is shown. Details are provided in Diagnostics section, showing the most effective methods for each circuit. Confirm the troubleshooting procedures first for the relevant circuit before beginning troubleshooting of that circuit.

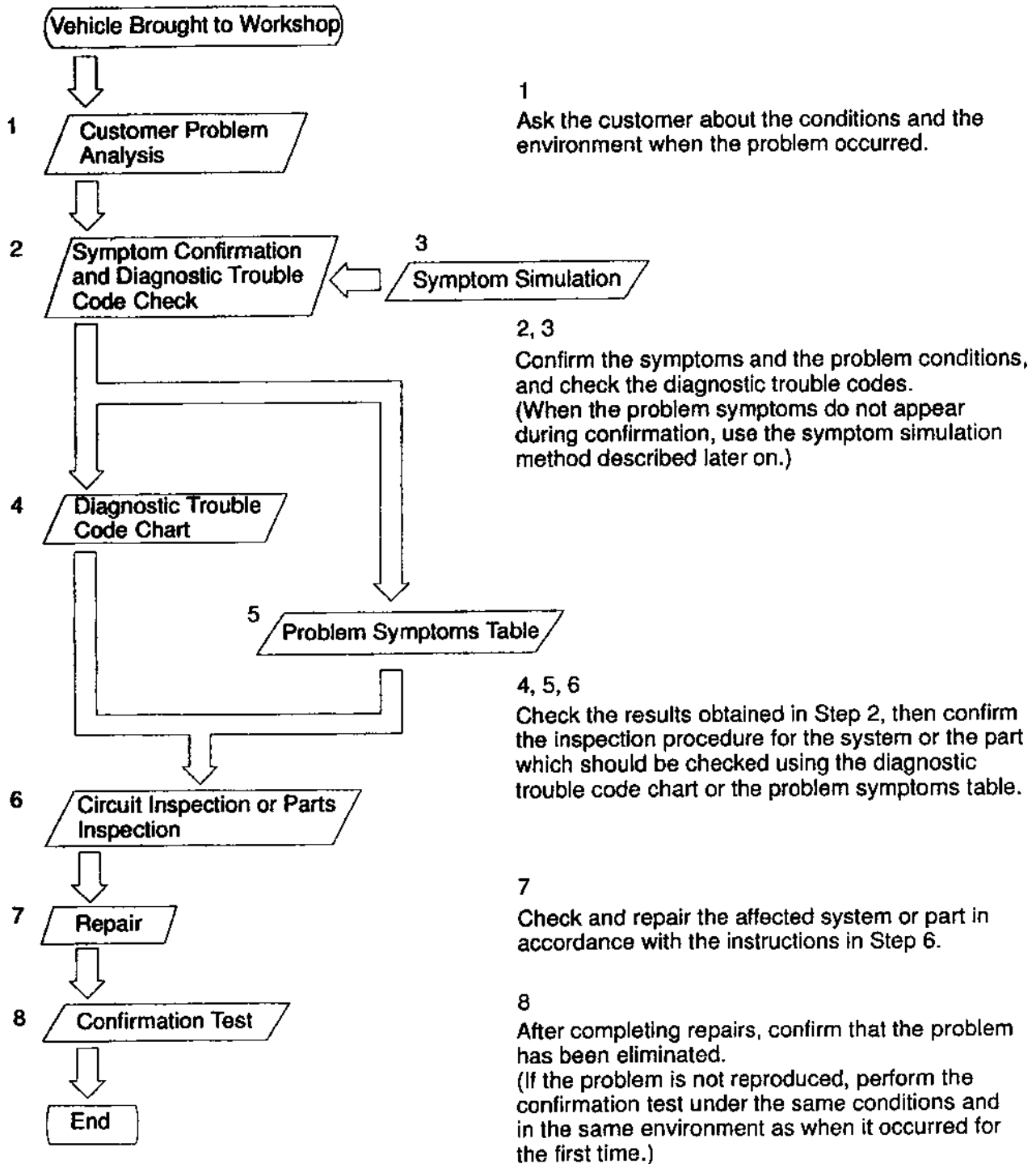

1. CUSTOMER PROBLEM ANALYSIS

In troubleshooting, the problem symptoms must be confirmed accurately and all preconceptions must be cleared away in order to give an accurate judgment. To ascertain just what the problem symptoms are, it is extremely important to ask the customer about the problem and the conditions at the time it occurred.

Important Point in the Problem Analysis:

The following 5 items are important points in the problem analysis. Past problems which are thought to be unrelated and the repair history, etc. may also help in some cases, so as much information as possible should be gathered and its relationship with the problem symptoms should be correctly ascertained for reference in troubleshooting. A customer problem analysis table is provided in Diagnostics section for each system for your use.

- Important Points in the Customer Problem Analysis**
- What ——— Vehicle model, system name
 - When ——— Date, time, occurrence frequency
 - Where ——— Road conditions
 - Under what conditions? ——— Running conditions, driving conditions, weather conditions
 - How did it happen? ——— Problem symptoms

(Sample) Engine control system check sheet.

CUSTOMER PROBLEM ANALYSIS CHECK			
ENGINE CONTROL SYSTEM Check Sheet		Inspector's Name _____	
Customer's Name		Model and Model Year	
Driver's Name		Frame No.	
Data Vehicle Brought In		Engine Model	
License No.		Odometer Reading	km miles
Problem Symptoms	<input type="checkbox"/> Engine does not Start	<input type="checkbox"/> Engine does not crank	<input type="checkbox"/> No initial combustion <input type="checkbox"/> No complete combustion
	<input type="checkbox"/> Difficult to Start	<input type="checkbox"/> Engine cranks slowly <input type="checkbox"/> Other _____	
	<input type="checkbox"/> Poor Idling	<input type="checkbox"/> Incorrect first idle <input type="checkbox"/> Idling rpm is abnormal <input type="checkbox"/> High (rpm) <input type="checkbox"/> Low (rpm) <input type="checkbox"/> Rough Idling <input type="checkbox"/> Other _____	
	<input type="checkbox"/> Poor Drive ability	<input type="checkbox"/> Hesitation <input type="checkbox"/> Back fire <input type="checkbox"/> Muffler explosion (after-fire) <input type="checkbox"/> Surging <input type="checkbox"/> Knocking <input type="checkbox"/> Other _____	
	<input type="checkbox"/> Engine Stall	<input type="checkbox"/> Soon after starting <input type="checkbox"/> After accelerator pedal depressed <input type="checkbox"/> After accelerator pedal released <input type="checkbox"/> During A/C operation <input type="checkbox"/> Shifting from N to D <input type="checkbox"/> Other _____	
	<input type="checkbox"/> Others	_____	
<input type="checkbox"/> Constant <input type="checkbox"/> Sometimes (times per day/month)			

2. SYMPTOM CONFIRMATION AND DIAGNOSTIC TROUBLE CODE CHECK

The diagnostic system in the CELICA fulfills various functions. The first function is the Diagnostic Trouble Code Check in which a malfunction in the signal circuits to the ECU is stored in code in the ECU memory at the time of occurrence, to be output by the technician during troubleshooting. Another function is the Input Signal Check which checks if the signals from various switches are sent to the ECU correctly.

By using these check functions, the problem areas can be narrowed down quickly and troubleshooting can be performed effectively. Diagnostic functions are incorporated in the following systems in the CELICA.

System	Diagnostic Trouble Code Check	Input Signal Check (Sensor Check)	Diagnostic Test Mode (Active Test)
Engine	<input type="radio"/> (with Check Mode)	<input type="radio"/>	<input type="radio"/>
Automatic Transaxle (U240E)	<input type="radio"/> (with Check Mode)	<input type="radio"/>	
Automatic Transaxle (U341E)	<input type="radio"/> (with Check Mode)	<input type="radio"/>	
Anti-Lock Brake System with Electronic Brake Force Distribution (EBD)	<input type="radio"/>	<input type="radio"/>	<input type="radio"/>
Supplemental Restraint System	<input type="radio"/>		
Cruise Control System	<input type="radio"/>		
Body Control System	<input type="radio"/>		

In diagnostic trouble code check, it is very important to determine whether the problem indicated by the diagnostic trouble code is still occurring or occurred in the past but returned to normal at present. In addition, it must be checked in the problem symptom check whether the malfunction indicated by the diagnostic trouble code is directly related to the problem symptom or not. For this reason, the diagnostic trouble codes should be checked before and after the symptom confirmation to determine the current conditions, as shown in the table below. If this is not done, it may, depending on the case, result in unnecessary troubleshooting for normally operating systems, thus making it more difficult to locate the problem, or in repairs not pertinent to the problem. Therefore, always follow the procedure in correct order and perform the diagnostic trouble code check.

DIAGNOSTIC TROUBLE CODE CHECK PROCEDURE

Diagnostic Trouble Code Check (Make a note of and then clear)	Confirmation of Symptoms	Diagnostic Trouble Code Check	Problem Condition
Diagnostic Trouble Code Display	Problem symptoms exist	Same diagnostic trouble code is displayed	Problem is still occurring in the diagnostic circuit
	No problem symptoms exist	Normal code is displayed	The problem is still occurring in a place other than in the diagnostic circuit (The diagnostic trouble code displayed first is either for a past problem or it is a secondary problem)
Normal Code Display		Problem symptoms exist	Normal code is displayed
	No problem symptoms exist	Normal code is displayed	The problem occurred in a place other than in the diagnostic circuit in the past

Taking into account the points on the previous page, a flow chart showing how to proceed with troubleshooting using the diagnostic trouble code check is shown below. This flow chart shows how to utilize the diagnostic trouble code check effectively, then by carefully checking the results, indicates how to proceed either to diagnostic trouble code troubleshooting or to troubleshooting of problem symptoms table.

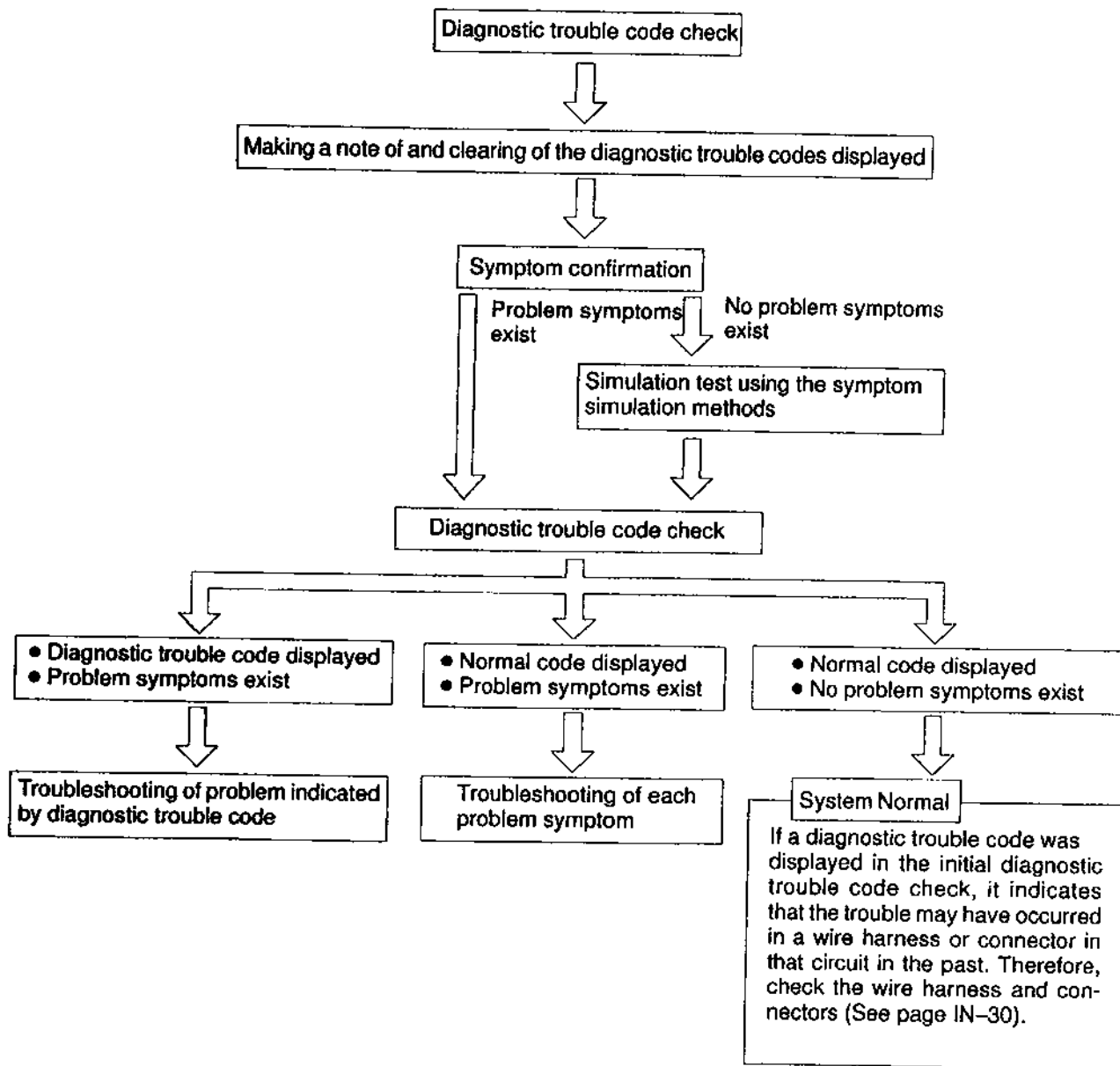



3. SYMPTOM SIMULATION

The most difficult case in troubleshooting is when there are no problem symptoms occurring. In such cases, a thorough customer problem analysis must be carried out, then simulate the same or similar conditions and environment in which the problem occurred in the customer's vehicle. No matter how much experience a technician has, or how skilled he may be, if he proceeds to troubleshoot without confirming the problem symptoms he will tend to overlook something important in the repair operation and make a wrong guess somewhere, which will only lead to a standstill. For example, for a problem which only occurs when the engine is cold, or for a problem which occurs due to vibration caused by the road during driving, etc., the problem can never be determined so long as the symptoms are confirmed with the engine hot condition or the vehicle at a standstill. Since vibration, heat or water penetration (moisture) is likely cause for problem which is difficult to reproduce, the symptom simulation tests introduced here are effective measures in that the external causes are applied to the vehicle in a stopped condition.

Important Points in the Symptom Simulation Test:

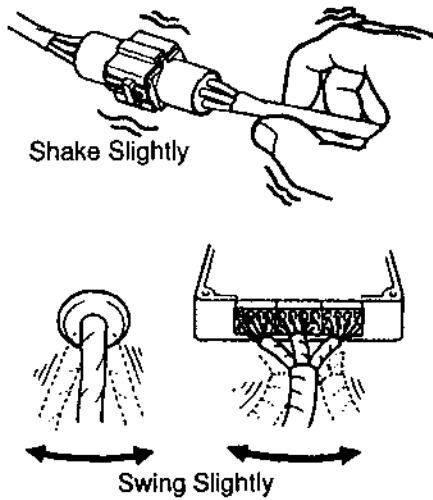
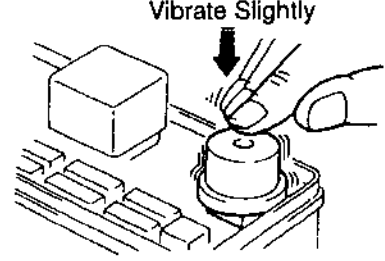
In the symptom simulation test, the problem symptoms should of course be confirmed, but the problem area or parts must also be found out. To do this, narrow down the possible problem circuits according to the symptoms before starting this test and connect a tester beforehand. After that, carry out the symptom simulation test, judging whether the circuit being tested is defective or normal and also confirming the problem symptoms at the same time. Refer to the problem symptoms table for each system to narrow down the possible causes of the symptom.

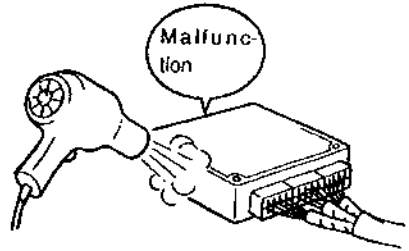
<p>1</p>	<p>VIBRATION METHOD: When vibration seems to be the major cause.</p>
<p>CONNECTORS Slightly shake the connector vertically and horizontally.</p> <p>WIRE HARNESS Slightly shake the wire harness vertically and horizontally. The connector joint, fulcrum of the vibration, and body through portion are the major areas to be checked thoroughly.</p>	 <p>Shake Slightly</p> <p>Swing Slightly</p> <p>F12331 F12332</p>
<p>PARTS AND SENSOR Apply slight vibration with a finger to the part of the sensor considered to be the problem cause and check that the malfunction occurs.</p> <p>HINT: Applying strong vibration to relays may result in open relays.</p>	 <p>Vibrate Slightly</p> <p>F12330</p>

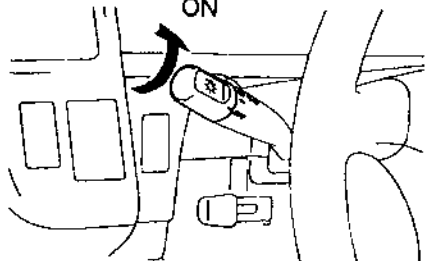
<p>2</p>	<p>HEAT METHOD: When the problem seems to occur when the suspect area is heated.</p>
<p>Heat the component that is the likely cause of the malfunction with a hair dryer or similar object. Check to see if the malfunction occurs.</p> <p>NOTICE:</p> <p>(1) Do not heat to more than 60 °C (140 °F). (Temperature is limited not to damage the components.)</p> <p>(2) Do not apply heat directly to parts in the ECU.</p>	 <p style="text-align: center;">FI2334</p>
<p>3</p>	<p>WATER SPRINKLING METHOD: When the malfunction seems to occur on a rainy day or in a high-humidity condition.</p>
<p>Sprinkle water onto the vehicle and check to see if the malfunction occurs.</p> <p>NOTICE:</p> <p>(1) Never sprinkle water directly into the engine compartment, but indirectly change the temperature and humidity by applying water spray onto the radiator front surface.</p> <p>(2) Never apply water directly onto the electronic components.</p> <p>HINT:</p> <p>If a vehicle is subject to water leakage, the leaked water may contaminate the ECU. When testing a vehicle with a water leakage problem, special caution must be taken.</p>	 <p style="text-align: center;">FI6649</p>
<p>4</p>	<p>OTHER: When a malfunction seems to occur when electrical load is excessive.</p>
<p>Turn on all electrical loads including the heater blower, head lights, rear window defogger, etc. and check to see if the malfunction occurs.</p>	 <p style="text-align: center;">B02389</p>

4. DIAGNOSTIC TROUBLE CODE CHART

The inspection procedure is shown in the table below. This table permits efficient and accurate troubleshooting using the diagnostic trouble codes displayed in the diagnostic trouble code check. Proceed with troubleshooting in accordance with the inspection procedure given in the diagnostic chart corresponding to the diagnostic trouble codes displayed. The engine diagnostic trouble code chart is shown below as an example.

- **DTC No.**
Indicates the diagnostic trouble code.
- **Page or Instructions**
Indicates the page where the inspection procedure for each circuit is to be found, or gives instructions for checking and repairs.

- **Trouble Area**
Indicates the suspect area of the problem.

- **Detection Item**
Indicates the system of the problem or contents of the problem.

DTC CHART (SAE Controlled)

HINT:
Parameters listed in the chart may not be exactly the same as your reading due to the type of instrument or other factors.

If a malfunction code is displayed during the DTC check mode, check the circuit for that code listed in the table below. For details of each code, turn to the page referred to under the "See page" for the respective "DTC No." in the DTC chart.

DTC No. (See page)	Detection Item	Trouble Area	MIL*	Memory
P0100 (DI-24)	Mass Air Flow Circuit Malfunction	<ul style="list-style-type: none"> • Open or short in mass air flow meter circuit • Mass air flow meter • ECM 	○	○
P0101 (DI-28)	Mass Air Flow Circuit Range/ Performance Problem	<ul style="list-style-type: none"> • Mass air flow meter 	○	○
P0110 (DI-29)	Intake Air Temp. Circuit Malfunction	<ul style="list-style-type: none"> • Open or short in intake air temp. sensor circuit • Intake air temp. sensor • ECM 	○	○
P0115 (DI-33)	Engine Coolant Temp. Circuit Malfunction	<ul style="list-style-type: none"> • Open or short in engine coolant temp. sensor circuit • Engine coolant temp. sensor • ECM 	○	○
P0116 (DI-37)	Engine Coolant Temp. Circuit Range/Performance Problem	<ul style="list-style-type: none"> • Engine coolant temp. sensor • Cooling system 	○	○
	Throttle Position Sensor/Switch Malfunction	<ul style="list-style-type: none"> • Open or short in throttle position sensor circuit • Throttle position sensor • ECM 		
	Throttle Position Sensor/Switch Range/Performance Problem	<ul style="list-style-type: none"> • Throttle position sensor 		

5. PROBLEM SYMPTOMS TABLE

The suspected circuits or parts for each problem symptom are shown in the table below. Use this table to troubleshoot the problem when a "Normal" code is displayed in the diagnostic trouble code check but the problem is still occurring. Numbers in the table indicate the inspection order in which the circuits or parts should be checked.

HINT:

When the problem is not detected by the diagnostic system even though the problem symptom is present, it is considered that the problem is occurring outside the detection range of the diagnostic system, or that the problem is occurring in a system other than the diagnostic system.

• Page
Indicates the page where the flow chart for each circuit is located.

• Circuit Inspection, Inspection Order
Indicates the circuit which needs to be checked for each problem symptom. Check in the order indicated by the numbers.

• Problem Symptom

• Circuit or Part Name
Indicates the circuit or part which needs to be checked.

Symptom	Suspect Area	See page
Engine does not crank (Does not start)	1. Starter and starter relay	ST-2 ST-17
No initial combustion (Does not start)	1. ECM power source circuit 2. Fuel pump control circuit 3. Engine control module (ECM)	DI-147 DI-151 IN-29
No complete combustion (Does not start)	1. Fuel pump control circuit	DI-151
Engine cranks normally (Difficult to start)	1. Starter signal circuit 2. Fuel pump control circuit 3. Compression	DI-144 DI-151 EM-3
Cold engine (Difficult to start)	1. Starter signal circuit 2. Fuel pump control circuit	DI-144 DI-151
Hot engine	1. Starter signal circuit 2. Fuel pump control circuit	DI-144 DI-151
High engine speed (Poor idling)	1. A/C signal circuit (Compressor circuit) 2. ECM power source circuit	AC-88
Low engine speed (Poor idling)	1. A/C signal circuit 2. Fuel pump control circuit	
	1. Compression	

6. CIRCUIT INSPECTION

How to read and use each page is shown below.

● Diagnostic Trouble Code No. and Detection Item

● Circuit Description
The major role and operation, etc. of the circuit and its component parts are explained.

DTC	P0325	Knock Sensor 1 Circuit Malfunction
------------	--------------	-------------------------------------------

CIRCUIT DESCRIPTION

Knock sensor is fitted to the cylinder block to detect engine knocking. This sensor contains a piezoelectric element which generates a voltage when it becomes deformed, which occurs when the cylinder block vibrates due to knocking. If engine knocking occurs, ignition timing is retarded to suppress it.

DTC No.	DTC Detecting Condition	Trouble Area
P0325	No knock sensor 1 signal to ECM with engine speed, 1,200 rpm or more.	<ul style="list-style-type: none"> ● Open or short in knock sensor1 circuit ● Knock sensor 1 (looseness) ● ECM

If the ECM detects the above diagnosis conditions, it operates the fail safe function in which the corrective retard angle value is set to the maximum value.

● Indicates the diagnostic trouble code, diagnostic trouble code set parameter and suspect area of the problem.

WIRING DIAGRAM

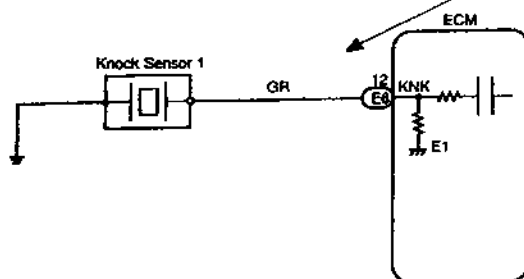

● Wiring Diagram
This shows a wiring diagram of the circuit. Use this diagram together with ELECTRICAL WIRING DIAGRAM to thoroughly understand the circuit.
Wire colors are indicated by an alphabetical code. B = Black, L = Blue, R = Red, BR = Brown, LG = Light Green, V = Violet, G = Green, O = Orange, W = White, GR = Gray, P = Pink, Y = Yellow, SB = Sky Blue
The first letter indicates the basic wire color and the second letter indicates the color of the stripe.

- Indicates the position of the ignition switch during the check.

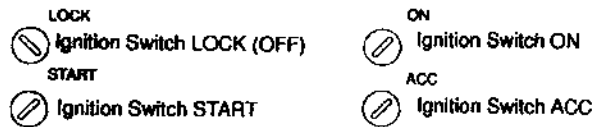

- Inspection Procedure**
Use the inspection procedure to determine if the circuit is normal or abnormal, and, if it is abnormal, use it to determine whether the problem is located in the sensors, actuators, wire harness or ECU.

INSPECTION PROCEDURE

1 Check continuity between terminal KNK of ECM connector and body ground.

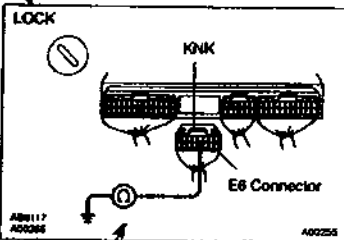

PREPARATION:
(a) Remove the glove compartment (See page SF-68).
(b) Disconnect the E6 connector of ECM.

CHECK:
Measure resistance between terminal KNK of ECM connector and body ground.

OK:
Resistance: 1 MΩ or higher

OK → Go to step 3.

NG

2 Check knock sensor (See page SF-61).

OK → Replace knock sensor.

- Indicates the place to check the voltage or resistance.
- Indicates the connector position to be checked, from the front or back side.

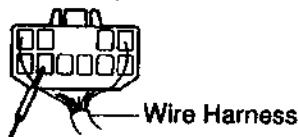

Check from the connector back side.
(with harness)



Check from the connector front side. (without harness)
In this case, care must be taken not to bend the terminals.

- Indicates the condition of the connector of ECU during the check.

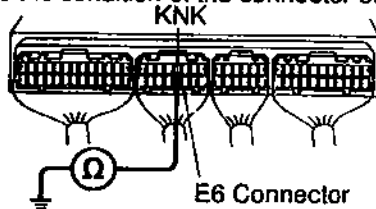

Connector being checked is connected.

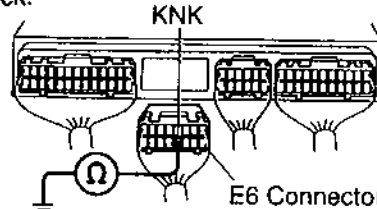

Connector being checked is disconnected.

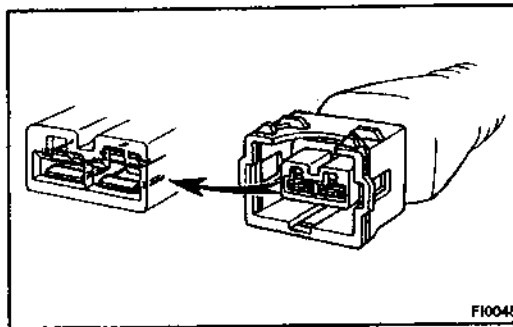
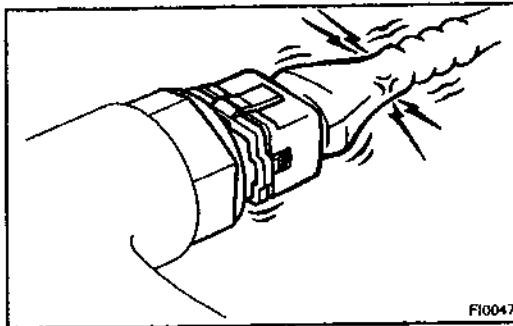
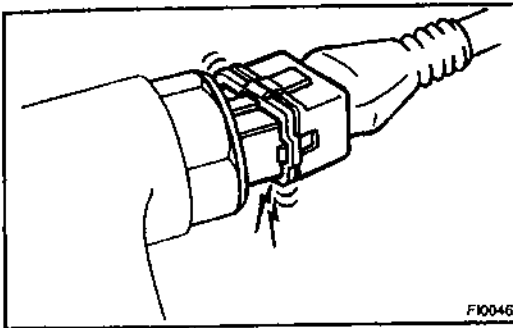

HOW TO USE THE DIAGNOSTIC CHART AND INSPECTION PROCEDURE

1. CONNECTOR CONNECTION AND TERMINAL INSPECTION

- For troubleshooting, diagnostic trouble code charts or problem symptom table are provided for each circuit with detailed inspection procedures on the following pages.
- When all the component parts, wire harnesses and connectors of each circuit except the ECU are found to be normal in troubleshooting, then it is determined that the problem is in the ECU. Accordingly, if diagnosis is performed without the problem symptoms occurring, refer to Step 8 to replace the ECU. So always confirm that the problem symptoms are occurring, or proceed with inspection while using the symptom simulation method.
- The instructions "Check wire harness and connector" and "Check and replace ECU" which appear in the inspection procedure, are common and applicable to all diagnostic trouble codes. Follow the procedure outlined below whenever these instructions appear.

OPEN CIRCUIT:

This could be due to a disconnected wire harness, faulty contact in the connector, and a connector terminal pulled out, etc.

HINT:

- It is rarely the case that a wire is broken in the middle of it. Most cases occur at the connector. In particular, carefully check the connectors of sensors and actuators
- Faulty contact could be due to rusting of the connector terminals, to foreign materials entering terminals or a deformation of connector terminals. Simply disconnecting and reconnecting the connectors once changes the condition of the connection and may result in a return to normal operation. Therefore, in troubleshooting, if no abnormality is found in the wire harness and connector check, but the problem disappears after the check, then the cause is considered to be in the wire harness or connectors.

SHORT CIRCUIT:

This could be due to a contact between wire harness and the body ground or to a short circuit occurred inside the switch, etc.

HINT:

When there is a short circuit between the wire harness and body ground, check thoroughly whether the wire harness is caught in the body or is clamped properly.

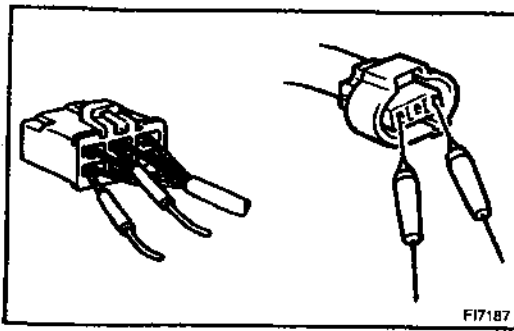

2. CONNECTOR HANDLING

When inserting tester probes into a connector, insert them from the rear of the connector. When necessary, use mini test leads. For water resistant connectors which cannot be accessed from behind, take good care not to deform the connector terminals.

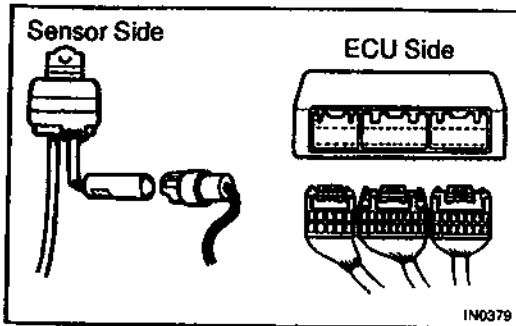

3. CONTINUITY CHECK (OPEN CIRCUIT CHECK)

- (a) Disconnect the connectors at both ECU and sensor sides.
- (b) Measure the resistance between the applicable terminals of the connectors.

Resistance: 1 Ω or less

HINT:

Measure the resistance while lightly shaking the wire harness vertically and horizontally.

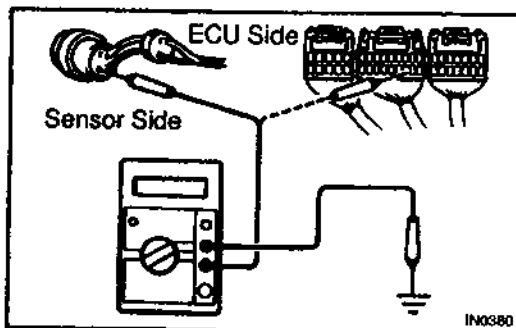
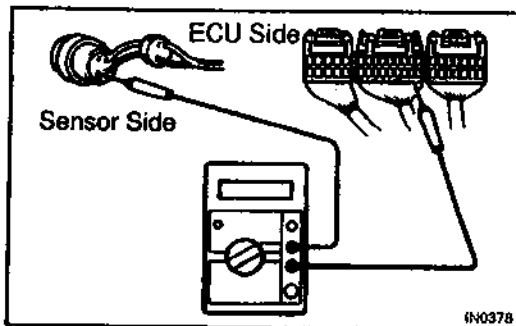

4. RESISTANCE CHECK (SHORT CIRCUIT CHECK)

- (a) Disconnect the connectors on both ends.
- (b) Measure the resistance between the applicable terminals of the connectors and body ground. Be sure to carry out this check on the connectors on both ends.

Resistance: 1 M Ω or higher

HINT:

Measure the resistance while lightly shaking the wire harness vertically and horizontally.

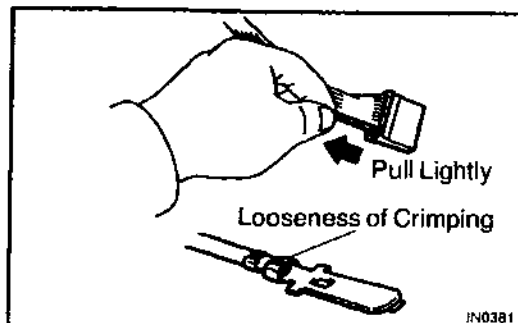

5. VISUAL CHECK AND CONTACT PRESSURE CHECK

- (a) Disconnect the connectors at both ends.
- (b) Check for rust or foreign material, etc. in the terminals of the connectors.
- (c) Check crimped portions for looseness or damage and check that the terminals are secured in lock portion.

HINT:

The terminals should not come out when pulled lightly from the back.

- (d) Prepare a test male terminal and insert it in the female terminal, then pull it out.

NOTICE:

When testing a gold-plated female terminal, always use a gold-plated male terminal.

HINT:

When the test terminal is pulled out more easily than others, there may be poor contact in that section.

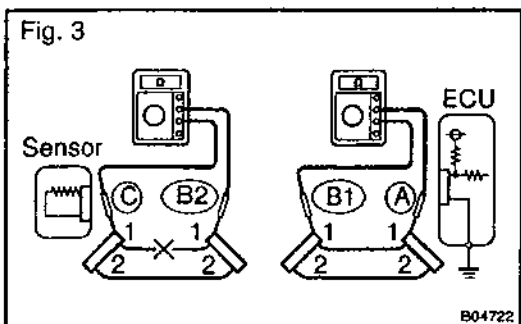
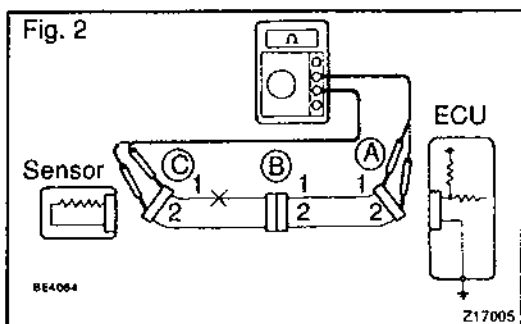
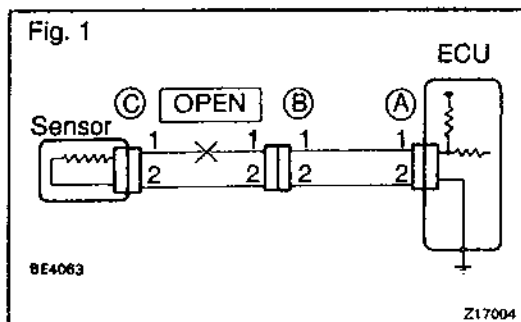
**6. CHECK OPEN CIRCUIT**

For the open circuit in the wire harness in Fig. 1, perform "(a) Continuity Check" or "(b) Voltage Check" to locate the section.

- (a) Check the continuity.

- (1) Disconnect connectors "A" and "C" and measure the resistance between them.

In the case of Fig. 2,

Between terminal 1 of connector "A" and terminal 1 of connector "C" → No continuity (open)

Between terminal 2 of connector "A" and terminal 2 of connector "C" → Continuity

Therefore, it is found out that there is an open circuit between terminal 1 of connector "A" and terminal 1 of connector "C".

- (2) Disconnect connector "B" and measure the resistance between the connectors.

In the case of Fig. 3,

Between terminal 1 of connector "A" and terminal 1 of connector "B1" → Continuity

Between terminal 1 of connector "B2" and terminal 1 of connector "C" → No continuity (open)

Therefore, it is found out that there is an open circuit between terminal 1 of connector "B2" and terminal 1 of connector "C".

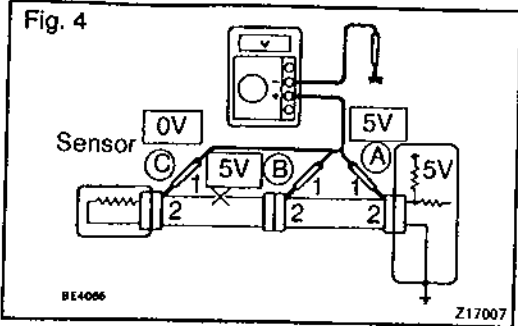

(b) Check the voltage.
 In a circuit in which voltage is applied (to the ECU connector terminal), an open circuit can be checked for by conducting a voltage check.

As shown in Fig. 4, with each connector still connected, measure the voltage between body ground and terminal 1 of connector "A" at the ECU 5V output terminal, terminal 1 of connector "B", and terminal 1 of connector "C", in that order.

If the results are:

5V: Between Terminal 1 of connector "A" and Body Ground

5V: Between Terminal 1 of connector "B" and Body Ground

0V: Between Terminal 1 of connector "C" and Body Ground

Then it is found out that there is an open circuit in the wire harness between terminal 1 of "B" and terminal 1 of "C".

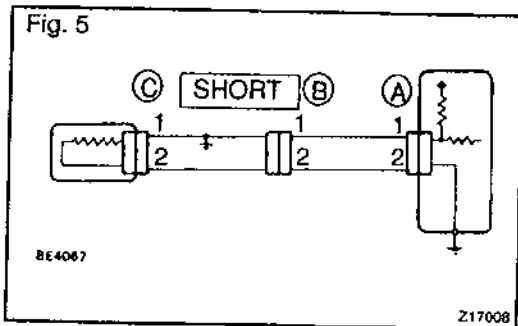

7. CHECK SHORT CIRCUIT

If the wire harness is ground shorted as in Fig. 5, locate the section by conducting a "continuity check with ground".

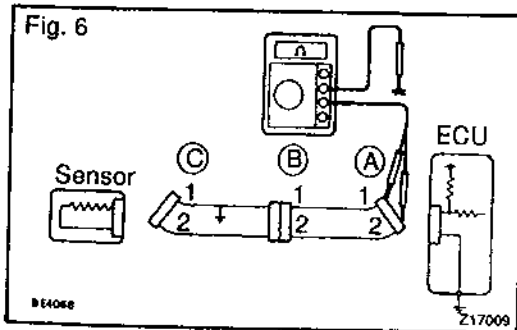

Check the continuity with ground.

- (1) Disconnect connectors "A" and "C" and measure the resistance between terminal 1 and 2 of connector "A" and body ground.

In the case of Fig. 6

Between terminal 1 of connector "A" and body ground → Continuity (short)

Between terminal 2 of connector "A" and body ground → No continuity

Therefore, it is found out that there is a short circuit between terminal 1 of connector "A" and terminal 1 of connector "C".

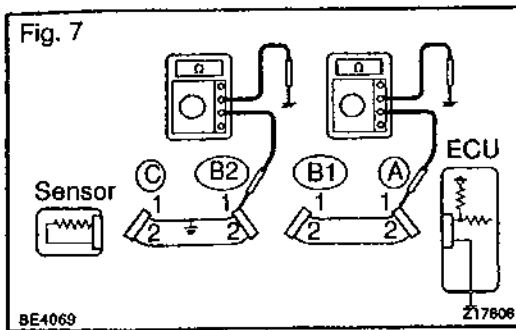

- (2) Disconnect connector "B" and measure the resistance between terminal 1 of connector "A" and body ground, and terminal 1 of connector "B2" and body ground.

Between terminal 1 of connector "A" and body ground → No continuity

Between terminal 1 of connector "B2" and body ground → Continuity (short)

Therefore, it is found out that there is a short circuit between terminal 1 of connector "B2" and terminal 1 of connector "C".

8. CHECK AND REPLACE ECU

First check the ECU ground circuit. If it is faulty, repair it. If it is normal, the ECU could be faulty, so replace the ECU with a normal functioning one and check that the symptoms appear.

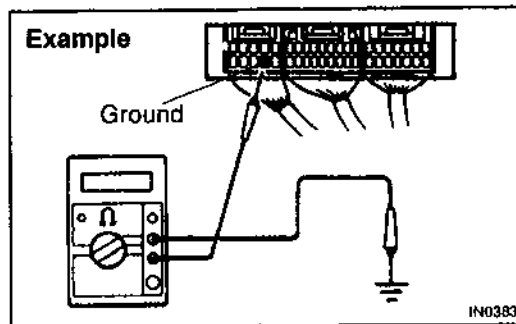

- (1) Measure the resistance between the ECU ground terminal and the body ground.

Resistance: 1 Ω or less

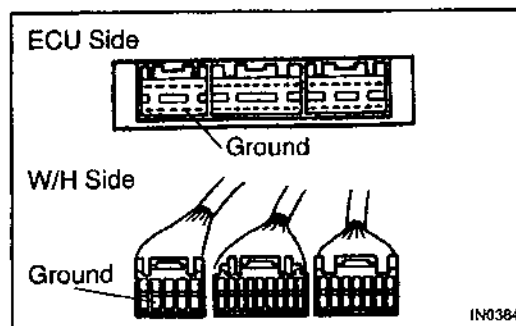

- (2) Disconnect the ECU connector, check the ground terminals on the ECU side and the wire harness side for bend and check the contact pressure.

TERMS**ABBREVIATIONS USED IN THIS MANUAL**

1984-07

Abbreviations	Meaning
ABS	Anti-Lock Brake System
AC	Alternating Current
ACC	Accessory
ACIS	Acoustic Control Induction System
ACSD	Automatic Cold Start Device
A.D.D.	Automatic Disconnecting Differential
A/F	Air-Fuel Ratio
AHC	Active Height Control Suspension
ALR	Automatic Locking Retractor
ALT	Alternator
AMP	Amplifier
ANT	Antenna
APPROX.	Approximately
A/T	Automatic Transmission (Transaxle)
ATF	Automatic Transmission Fluid
AUTO	Automatic
AUX	Auxiliary
AVG	Average
AVS	Adaptive Variable Suspension
BA	Brake Assist
BACS	Boost Altitude Compensation System
BAT	Battery
BDC	Bottom Dead Center
B/L	Bi-Level
B/S	Bore-Stroke Ratio
BTDC	Before Top Dead Center
BVSV	Bimetallic Vacuum Switching Valve
Calif.	California
CB	Circuit Breaker
CCo	Catalytic Converter For Oxidation
CD	Compact Disc
CF	Cornering Force
CG	Center Of Gravity
CH	Channel
COMB.	Combination
CPE	Coupe
CPS	Combustion Pressure Sensor
CPU	Central Processing Unit
CRS	Child Restraint System
CTR	Center
CV	Check Valve
CV	Control Valve

CW	Curb Weight
DC	Direct Current
DEF	Defogger
DFL	Deflector
DIFF.	Differential
DIFF. LOCK	Differential Lock
D/INJ	Direct Injection
DLI	Distributorless Ignition
DOHC	Double Over Head Cam
DP	Dash Pot
DS	Dead Soak
DSP	Digital Signal Processor
EBD	Electronic Brake Force Distribution
ECAM	Engine Control And Measurement System
ECD	Electronic Controlled Diesel
ECDY	Eddy Current Dynamometer
ECU	Electronic Control Unit
ED	Electro-Deposited Coating
EDU	Electronic Driving Unit
EDIC	Electric Diesel Injection Control
EFI	Electronic Fuel Injection
E/G	Engine
EGR-VM	Egr-Vacuum Modulator
ELR	Emergency Locking Retractor
ENG	Engine
ESA	Electronic Spark Advance
ETCS	Electronic Throttle Control System
EVP	Evaporator
E-VRV	Electric Vacuum Regulating Valve
EXH	Exhaust
FE	Fuel Economy
FF	Front-Engine Front-Wheel-Drive
F/G	Fuel Gage
FIPG	Formed In Place Gasket
FL	Fusible Link
F/P	Fuel Pump
FPU	Fuel Pressure Up
Fr	Front
FR	Front-Engine Rear-Wheel-Drive
FW	Flywheel
FW/D	Flywheel Damper
FWD	Front-Wheel-Drive
GAS	Gasoline
GND	Ground
HAC	High Altitude Compensator
H/B	Hatchback

H-FUSE	High Current Fuse
HI	High
HID	High Intensity Discharge (Head Lamp)
HSG	Housing
HT	Hard Top
HWS	Heated Windshield System
IAC	Idle Air Control
IC	Integrated circuit
IDI	Indirect Diesel Injection
IFS	Independent Front Suspension
IG	Ignition
IIA	Integrated Ignition Assembly
IN	Intake (Manifold, Valve)
INT	Intermittent
IP	Instrument Panel
IRS	Independent Rear Suspension
J/B	Junction Block
J/C	Junction Connector
KD	Kick-Down
LAN	Local Area Network
LB	Liftback
LCD	Liquid Crystal Display
LED	Light Emitting Diode
LH	Left-Hand
LHD	Left-Hand Drive
L/H/W	Length, Height, Width
LLC	Long-Life Coolant
LNG	Liquified Natural Gas
LO	Low
LPG	Liquified Petroleum Gas
LSD	Limited Slip Differential
LSP & PV	Load Sensing Proportioning And Bypass Valve
LSPV	Load Sensing Proportioning Valve
MAX.	Maximum
MIC	Microphone
MIL	Malfunction Indicator Lamp
MIN.	Minimum
MP	Multipurpose
MPX	Multiplex Communication System
M/T	Manual Transmission
MT	Mount
MTG	Mounting
N	Neutral
NA	Natural Aspiration
No.	Number
O/D	Overdrive

INTRODUCTION - TERMS

OEM	Original Equipment Manufacturing
OHC	Overhead Camshaft
OHV	Overhead Valve
OPT	Option
O/S	Oversize
P & BV	Proportioning And Bypass Valve
PCS	Power Control System
PCV	Positive Crankcase Ventilation
PKB	Parking Brake
PPS	Progressive Power Steering
PS	Power Steering
PTO	Power Take-Off
R & P	Rack And Pinion
R/B	Relay Block
RBS	Recirculating Ball Type Steering
R/F	Reinforcement
RFS	Rigid Front Suspension
RRS	Rigid Rear Suspension
RH	Right-Hand
RHD	Right-Hand Drive
RLY	Relay
ROM	Read Only Memory
Rr	Rear
RR	Rear-Engine Rear-Wheel Drive
RWD	Rear-Wheel Drive
SDN	Sedan
SEN	Sensor
SICS	Starting Injection Control System
SOC	State Of Charge
SOHC	Single Overhead Camshaft
SPEC	Specification
SPI	Single Point Injection
SRS	Supplemental Restraint System
SSM	Special Service Materials
SST	Special Service Tools
STD	Standard
STJ	Cold-Start Fuel Injection
SW	Switch
SYS	System
T/A	Transaxle
TACH	Tachometer
TBI	Throttle Body Electronic Fuel Injection
TC	Turbocharger
TCCS	TOYOTA Computer-Controlled System
TCV	Timing Control Valve
TDC	Top Dead Center

TEMP.	Temperature
TEMS	TOYOTA Electronic Modulated Suspension
TIS	Total Information System For Vehicle Development
T/M	Transmission
TMC	TOYOTA Motor Corporation
TMMK	TOYOTA Motor Manufacturing Kentucky, Inc.
TRAC	Traction Control System
TURBO	Turbocharge
U/D	Underdrive
U/S	Undersize
VCV	Vacuum Control Valve
VENT	Ventilator
VIN	Vehicle Identification Number
VPS	Variable Power Steering
VSC	Vehicle Skid Control
VSV	Vacuum Switching Valve
VTV	Vacuum Transmitting Valve
w/	With
WGN	Wagon
W/H	Wire Harness
w/o	Without
1st	First
2nd	Second
2WD	Two Wheel Drive Vehicle (4x2)
4WD	Four Wheel Drive Vehicle (4x4)

GLOSSARY OF SAE AND TOYOTA TERMS

This glossary lists all SAE--J1930 terms and abbreviations used in this manual in compliance with SAE recommendations, as well as their TOYOTA equivalents.

SAE ABBREVIATIONS	SAE TERMS	TOYOTA TERMS ()—ABBREVIATIONS
A/C	Air Conditioning	Air Conditioner
ACL	Air Cleaner	Air Cleaner, A/CL
AIR	Secondary Air Injection	Air Injection (AI)
AP	Accelerator Pedal	--
B+	Battery Positive Voltage	+B, Battery Voltage
BARO	Barometric Pressure	HAC
CAC	Charge Air Cooler	Intercooler
CARB	Carburetor	Carburetor
CFI	Continuous Fuel Injection	--
CKP	Crankshaft Position	Crank Angle
CL	Closed Loop	Closed Loop
CMP	Camshaft Position	Cam Angle
CPP	Clutch Pedal Position	--
CTOX	Continuous Trap Oxidizer	--
CTP	Closed Throttle Position	LL ON, Idle ON
DFI	Direct Fuel Injection (Diesel)	Direct Injection (DI)
DI	Distributor Ignition	--
DLC1 DLC2 DLC3	Data Link Connector 1 Data Link Connector 2 Data Link Connector 3	1: Check Connector 2: Total Diagnosis Communication Link (TDCL) 3: OBD II Diagnostic Connector
DTC	Diagnostic Trouble Code	Diagnostic Code
DTM	Diagnostic Test Mode	--
ECL	Engine Control Level	--
ECM	Engine Control Module	Engine ECU (Electronic Control Unit)
ECT	Engine Coolant Temperature	Coolant Temperature, Water Temperature (THW)
EEPROM	Electrically Erasable Programmable Read Only Memory	Electrically Erasable Programmable Read Only Memory (EEPROM), Erasable Programmable Read Only Memory (EPROM)
EFE	Early Fuel Evaporation	Cold Mixture Heater (CMH), Heat Control Valve (HCV)
EGR	Exhaust Gas Recirculation	Exhaust Gas Recirculation (EGR)
EI	Electronic Ignition	TOYOTA Distributorless Ignition (TDI)
EM	Engine Modification	Engine Modification (EM)
EPROM	Erasable Programmable Read Only Memory	Programmable Read Only Memory (PROM)
EVAP	Evaporative Emission	Evaporative Emission Control (EVAP)
FC	Fan Control	--
FEEPROM	Flash Electrically Erasable Programmable Read Only Memory	--
FEPROM	Flash Erasable Programmable Read Only Memory	--
FF	Flexible Fuel	--
FP	Fuel Pump	Fuel Pump
GEN	Generator	Alternator
GND	Ground	Ground (GND)

HO2S	Heated Oxygen Sensor	Heated Oxygen Sensor (HO ₂ S)
IAC	Idle Air Control	Idle Speed Control (ISC)
IAT	Intake Air Temperature	Intake or Inlet Air Temperature
ICM	Ignition Control Module	-
IFI	Indirect Fuel Injection	Indirect Injection (IDL)
IFS	Inertia Fuel-Shutoff	-
ISC	Idle Speed Control	-
KS	Knock Sensor	Knock Sensor
MAF	Mass Air Flow	Air Flow Meter
MAP	Manifold Absolute Pressure	Manifold Pressure Intake Vacuum
MC	Mixture Control	Electric Bleed Air Control Valve (EBCV) Mixture Control Valve (MCV) Electric Air Control Valve (EACV)
MDP	Manifold Differential Pressure	-
MFI	Multiport Fuel Injection	Electronic Fuel Injection (EFI)
MIL	Malfunction Indicator Lamp	Check Engine Lamp
MST	Manifold Surface Temperature	-
MVZ	Manifold Vacuum Zone	-
NVRAM	Non-Volatile Random Access Memory	-
O2S	Oxygen Sensor	Oxygen Sensor, O ₂ Sensor (O ₂ S)
OBD	On-Board Diagnostic	On-Board Diagnostic System (OBD)
OC	Oxidation Catalytic Converter	Oxidation Catalyst Convert (OC), CCo
OP	Open Loop	Open Loop
PAIR	Pulsed Secondary Air Injection	Air Suction (AS)
PCM	Powertrain Control Module	-
PNP	Park/Neutral Position	-
PROM	Programmable Read Only Memory	-
PSP	Power Steering Pressure	-
PTOX	Periodic Trap Oxidizer	Diesel Particulate Filter (DPF) Diesel Particulate Trap (DPT)
RAM	Random Access Memory	Random Access Memory (RAM)
RM	Relay Module	-
ROM	Read Only Memory	Read Only Memory (ROM)
RPM	Engine Speed	Engine Speed
SC	Supercharger	Supercharger
SCB	Supercharger Bypass	E-ABV
SFI	Sequential Multiport Fuel Injection	Electronic Fuel Injection (EFI), Sequential Injection
SPL	Smoke Puff Limiter	-
SRI	Service Reminder Indicator	-
SRT	System Readiness Test	-
ST	Scan Tool	-
TB	Throttle Body	Throttle Body
TBI	Throttle Body Fuel Injection	Single Point Injection Central Fuel Injection (CI)
TC	Turbocharger	Turbocharger
TCC	Torque Converter Clutch	Torque Converter

INTRODUCTION - TERMS

TCM	Transmission Control Module	Transmission ECU, ECT ECU
TP	Throttle Position	Throttle Position
TR	Transmission Range	-
TVV	Thermal Vacuum Valve	Bimetallic Vacuum Switching Valve (BVSV) Thermostatic Vacuum Switching Valve (TVSV)
TWC	Three-Way Catalytic Converter	Three-Way Catalytic (TWC) Manifold Converter CC _{RO}
TWC+OC	Three-Way + Oxidation Catalytic Converter	CC _R + CC _O
VAF	Volume Air Flow	Air Flow Meter
VR	Voltage Regulator	Voltage Regulator
VSS	Vehicle Speed Sensor	Vehicle Speed Sensor
WOT	Wide Open Throttle	Full Throttle
WU-OC	Warm Up Oxidation Catalytic Converter	-
WU-TWC	Warm Up Three-Way Catalytic Converter	-
3GR	Third Gear	-
4GR	Fourth Gear	-

MAINTENANCE

OUTSIDE VEHICLE	MA-1
INSIDE VEHICLE	MA-2
UNDER HOOD	MA-4 MA
ENGINE	MA-5
BRAKE	MA-6
CHASSIS	MA-7

MA

OUTSIDE VEHICLE

GENERAL MAINTENANCE

MA001-09

These are maintenance and inspection items which are considered to be the owner's responsibility. They can be done by the owner or they can have them done at a service shop.

These items include those which should be checked on a daily basis, those which, in most cases, do not require (special) tools and those which are considered to be reasonable for the owner to do.

Items and procedures for general maintenance are as follows.

1. GENERAL NOTES

- Maintenance items may vary from country to country. Check the owner's manual supplement in which the maintenance schedule is shown.
- Every service item in the periodic maintenance schedule must be performed.
- Periodic maintenance service must be performed according to whichever interval in the periodic maintenance schedule occurs first, the odometer reading (miles) or the time interval (months).
- Maintenance service after the last period should be performed at the same interval as before unless otherwise noted.
- Failure to do even one item can cause the engine to run poorly and increase exhaust emissions.

2. TIRES

- (a) Check the pressure with a gauge. If necessary, adjust.
- (b) Check for cuts, damage or excessive wear.

3. WHEEL NUTS

When checking the tires, check the nuts for looseness or for missing nuts. If necessary, tighten them.

4. TIRE ROTATION

Check the owner's manual supplement in which the maintenance schedule is shown.

5. WINDSHIELD WIPER BLADES

Check for wear or cracks whenever they do not wipe clean. If necessary, replace.

6. FLUID LEAKS

- (a) Check underneath for leaking fuel, oil, water or other fluid.
- (b) If you smell gasoline fumes or notice any leak, have the cause found and corrected.

7. DOORS AND ENGINE HOOD

- (a) Check that all doors and the tailgate operate smoothly, and that all latches lock securely.
- (b) Check that the engine hood secondary latch secures the hood from opening when the primary latch is released.

MA

INSIDE VEHICLE

GENERAL MAINTENANCE

These are maintenance and inspection items which are considered to be the owner's responsibility. They can be done by the owner or they can have them done at a service shop.

These items include those which should be checked on a daily basis, those which, in most cases, do not require (special) tools and those which are considered to be reasonable for the owner to do.

MA Items and procedures for general maintenance are as follows.

1. GENERAL NOTES

- Maintenance items may vary from country to country. Check the owner's manual supplement in which the maintenance schedule is shown.
- Every service item in the periodic maintenance schedule must be performed.
- Periodic maintenance service must be performed according to whichever interval in the periodic maintenance schedule occurs first, the odometer reading (miles) or the time interval (months).
- Maintenance service after the last period should be performed at the same interval as before unless otherwise noted.
- Failure to do even one item can cause the engine to run poorly and increase exhaust emissions.

2. LIGHTS

- (a) Check that the headlights, stop lights, taillights, turn signal lights, and other lights are all working.
- (b) Check the headlight aim.

3. WARNING LIGHTS AND BUZZERS

Check that all warning lights and buzzers function properly.

4. HORN

Check that it is working.

5. WINDSHIELD GLASS

Check for scratches, pits or abrasions.

6. WINDSHIELD WIPER AND WASHER

- (a) Check operation of the wipers and washer.
- (b) Check that the wipers do not streak.

7. WINDSHIELD DEFROSTER

Check that air comes out from the defroster outlet when operating the heater or air conditioner.

8. REAR VIEW MIRROR

Check that it is mounted securely.

9. SUN VISORS

Check that they move freely and are mounted securely.

10. STEERING WHEEL

Check that it has the specified freeplay. Be alert for changes in steering condition, such as hard steering, excessive freeplay or strange noises.

11. SEATS

- (a) Check that the seat adjusters operate smoothly.
- (b) Check that all latches lock securely in any position.
- (c) For fold-down seat backs, check that the latches lock securely.

12. SEAT BELTS

- (a) Check that the seat belt system such as the buckles, retractors and anchors operate properly and smoothly.
- (b) Check that the belt webbing is not cut, frayed, worn or damaged.

13. ACCELERATOR PEDAL

Check the pedal for smooth operation and uneven pedal effort or catching.

14. CLUTCH PEDAL (See page CL-2)

- (a) Check the pedal for smooth operation.
- (b) Check that the pedal has the proper freeplay.

15. BRAKE PEDAL (See page BR-6)

- (a) Check the pedal for smooth operation.
- (b) Check that the pedal has the proper reserve distance and freeplay.
- (c) Check the brake booster function.

16. BRAKES

At a safe place, check that the brakes do not pull to one side when applied.

17. PARKING BRAKE (See page BR-8)

- (a) Check that the lever has the proper travel.
- (b) On a safe incline, check that the vehicle is held securely with only the parking brake applied.

18. AUTOMATIC TRANSMISSION "PARK" MECHANISM

- (a) Check the lock release button of the selector lever for proper and smooth operation.
- (b) On a safe incline, check that the vehicle is held securely with the selector lever in "P" position and all brakes released.

UNDER HOOD

MA003-08

GENERAL MAINTENANCE

1. GENERAL NOTES

- Maintenance items may vary from country to country. Check the owner's manual supplement in which the maintenance schedule is shown.
- Every service item in the periodic maintenance schedule must be performed.
- Periodic maintenance service must be performed according to whichever interval in the periodic maintenance schedule occurs first, the odometer reading (miles) or the time interval (months).
- Maintenance service after the last period should be performed at the same interval as before unless otherwise noted.
- Failure to do even one item can cause the engine to run poorly and increase exhaust emissions.

2. WINDSHIELD WASHER FLUID

Check that there is sufficient fluid in the tank.

3. ENGINE COOLANT LEVEL

Check that the coolant level is between the "FULL" and "LOW" lines on the see-through reservoir.

4. RADIATOR AND HOSES

- (a) Check that the front of the radiator is clean and not blocked with leaves, dirt or bugs.
- (b) Check the hoses for cracks, kinks, rot or loose connections.

5. BATTERY ELECTROLYTE LEVEL

Check that the electrolyte level of all battery cells is between the upper and lower level lines on the case.

6. BRAKE AND CLUTCH FLUID LEVELS

Check that the brake and clutch fluid levels are near the upper level line on the see-through reservoirs.

7. ENGINE DRIVE BELTS

Check drive belt for fraying, cracks, wear or oiliness.

8. ENGINE OIL LEVEL

Check the level on the dipstick with the engine turned off.

9. POWER STEERING FLUID LEVEL

- Check the level.
- The level should be in the "HOT" or "COLD" range depending on the fluid temperature.

10. AUTOMATIC TRANSMISSION FLUID LEVEL

- (a) Park the vehicle on a level surface.
- (b) With the engine idling and the parking brake applied, shift the selector into all positions from "P" to "L", and then shift into "P" position.
- (c) Pull out the dipstick and wipe off the fluid with a clean rag. Re-insert the dipstick and check that the fluid level is in the HOT range.
- (d) Do this check with the fluid at normal driving temperature (70 – 80°C, 158 – 176°F).

HINT:

Wait until the engine cools down (approx. 30 min.) before checking the fluid level after extended driving at high speeds, in hot weather, in heavy traffic or pulling a trailer.

11. EXHAUST SYSTEM

If any change in the sound of the exhaust or smell of the exhaust fumes is noticed, have the cause located and corrected.

ENGINE INSPECTION

MAJOR-06

HINT:

Inspect these items when the engine is cold.

1. **INSPECT DRIVE BELT**
(See page CH-2)
2. **REPLACE SPARK PLUGS**
(See page IG-1)

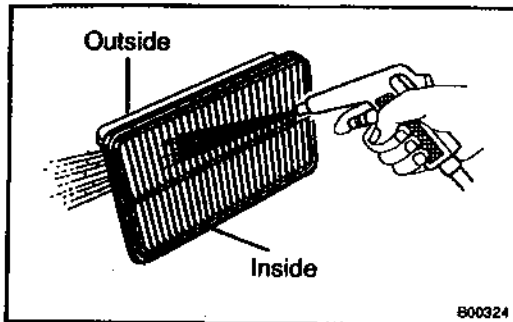

3. **INSPECT AIR FILTER**

- (a) Visually check that the air filter is not excessively dirty or oily.

HINT:

Oiliness may indicate a stuck PCV valve.

If necessary, replace the air cleaner element.

- (b) Clean the air filter with compressed air.
First blow from the inside thoroughly, then blow off the outside of the element.

4. **REPLACE AIR FILTER**

Replace the air filter with a new one.

5. **REPLACE ENGINE OIL AND OIL FILTER**
(See page LU-3)
6. **REPLACE ENGINE COOLANT**
(See page CO-2)
7. **REPLACE GASKET IN FUEL TANK CAP**
(See page SF-28)
8. **INSPECT FUEL LINES AND CONNECTIONS**
(See page SF-28)
9. **INSPECT EXHAUST PIPES AND MOUNTINGS**
(See page EC-11)
10. **ADJUST VALVE CLEARANCE**
(See page EM-4)

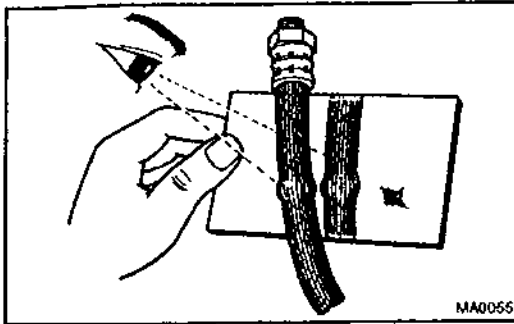

BRAKE INSPECTION

MA0054-03

1. INSPECT BRAKE LINE PIPES AND HOSES

HINT:

Check in a well lighted area. Check the entire circumference and length of the brake hoses using a mirror as required. Turn the front wheels fully right or left before checking the front brake.

- (a) Check all brake lines and hoses for:
 - Damage
 - Wear
 - Deformation
 - Cracks
 - Corrosion
 - Leaks
 - Bends
 - Twists
 - (b) Check all clamps for tightness and connections for leakage.
 - (c) Check that the hoses and lines are clear of sharp edges, moving parts and the exhaust system.
 - (d) Check that the lines installed in grommets pass through the center of the grommets.
2. **INSPECT FRONT BRAKE PADS AND DISCS**
(See page BR-18)
 3. **INSPECT REAR BRAKE PADS AND DISCS**
(See page BR-34)
 4. **INSPECT BRAKE LININGS AND DRUMS**
(See page BR-39)

CHASSIS INSPECTION

MA609-01

1. INSPECT STEERING LINKAGE

- (a) Check the steering wheel freeplay (See page SR-8).
- (b) Check the steering linkage for looseness or damage.

Check that:

- Tie rod ends do not have excessive play.
- Dust seals and boots are not damaged.
- Boot clamps are not loose.

2. INSPECT STEERING GEAR HOUSING OIL

Check the steering gear housing for oil leakage.

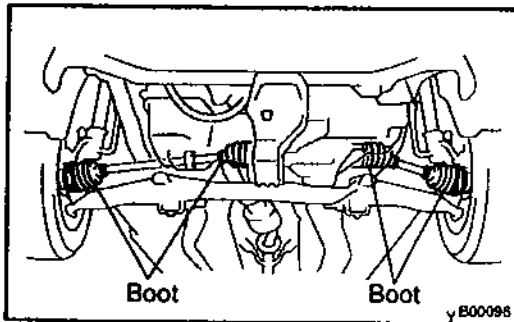

3. INSPECT DRIVE SHAFT BOOTS

Check the drive shaft boots for clamp looseness, leakage or damage.

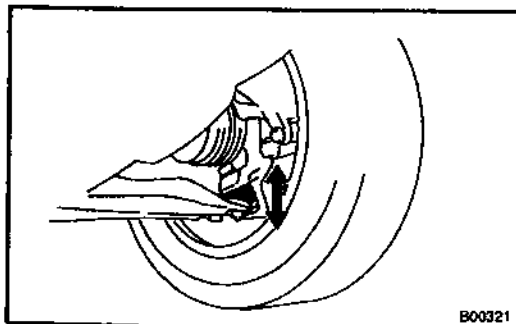

4. INSPECT BALL JOINT AND DUST COVERS

- (a) Inspect the ball joints for excessive looseness.
 - Jack up the front of the vehicle and place wooden blocks with a height of 180 – 200 mm (7.09 – 7.87 in.) under the front tires.
 - Lower the jack until there is about half a load on the front coil spring. Place stands under the vehicle for safety.
 - Check that the front wheels are pointing straight ahead, and block them with chocks.
 - Using a lever, pry up the end of the lower arm, and check the amount of play.

Maximum ball joint vertical play:

0 mm (0 in.)

If there is play, replace the ball joint.

- (b) Check the dust cover for damage.

5. CHECK TRANSAXLE OIL (FLUID)

Visually check the transaxle for oil (fluid) leakage.
If leakage is found, check for the cause and repair.

6. REPLACE TRANSAXLE FLUID**(a) M/T:**

Replace transaxle oil.

(C56: See page MX-4)

(C60: See page MX-4)

(b) A/T:

Replace transaxle (transmission) fluid.

(U240E: See page DI-157)

(U341E: See page DI-220)

7. TIGHTEN BOLTS AND NUTS ON CHASSIS AND BODY

If the vehicle is mainly operated under the rough, muddy road conditions, Tighten the seat mounting bolts and front and rear suspension member retaining bolts to specified torque.

- Seat mounting bolts

Torque: 37 N·m (375 kgf·cm, 27 ft·lbf)

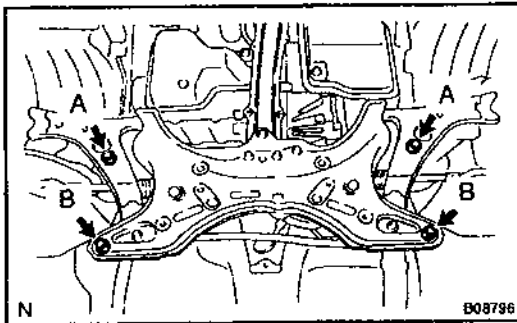

- Front suspension member – to body mounting bolts

Torque:

Bolt A 113 N·m (1,152 kgf·cm, 83 ft·lbf)

Bolt B 157 N·m (1,600 kgf·cm, 116 ft·lbf)

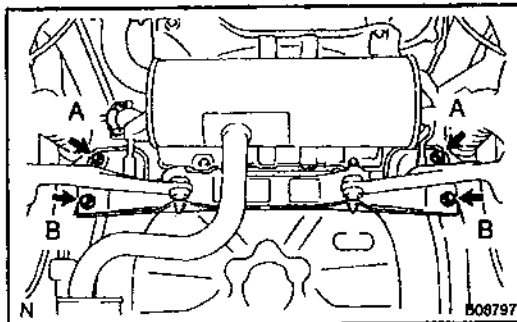

- Rear suspension member – to body mounting bolts

Torque:

Bolt A 80 N·m (816 kgf·cm, 59 ft·lbf)

Bolt B 130 N·m (1,326 kgf·cm, 96 ft·lbf)

PREPARATION

MAINTENANCE	PP-1
ENGINE MECHANICAL	PP-2
EMISSION CONTROL	PP-7
SFI	PP-8
COOLING	PP-11
LUBRICATION	PP-15
IGNITION	PP-19
STARTING	PP-21
CHARGING	PP-24
CLUTCH	PP-27
MANUAL TRANSAXLE (C56)	PP-31
MANUAL TRANSAXLE (C60)	PP-38
AUTOMATIC TRANSAXLE (U240E)	PP-46
AUTOMATIC TRANSAXLE (U341E)	PP-51
SUSPENSION AND AXLE	PP-56
BRAKE	PP-62
STEERING	PP-67
SUPPLEMENTAL RESTRAINT SYSTEM ...	PP-74
BODY ELECTRICAL	PP-77
BODY	PP-80
AIR CONDITIONING	PP-85

PP

MAINTENANCE EQUIPMENT

PP-02

Mirror	Brake hose
Torque wrench	









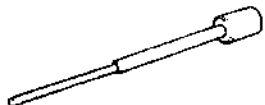

PP

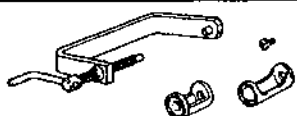
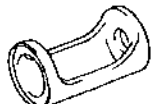





ENGINE MECHANICAL

SST (Special Service Tools)

PP2E1-01

PP



	<p>09032-00100 Oil Pan Seal Cutter</p>	
	<p>09201-01055 Valve Guide Bushing Remover & Replacer 5.5</p>	
	<p>09201-41020 Valve Stem Oil Seal Replacer</p>	
	<p>09202-70020 Valve Spring Compressor</p>	
	<p>(09202-00020) Attachment</p>	
	<p>09213-70010 Crankshaft Pulley Holding Tool</p>	
	<p>09222-30010 Connecting Rod Bushing Remover & Replacer</p>	
	<p>09223-15030 Oil Seal & Bearing Replacer</p>	
	<p>09223-22010 Crankshaft Front Oil Seal Replacer</p>	
	<p>09309-37010 Transmission Bearing Replacer</p>	
	<p>09330-00021 Companion Flange Holding Tool</p>	
	<p>09816-30010 Oil Pressure Switch Socket</p>	

	<p>09950-50012 Puller C Set</p>	
	<p>(09951-05010) Hanger 150</p>	
	<p>(09952-05010) Slide Arm</p>	
	<p>(09953-05020) Center Bolt 150</p>	
	<p>(09954-05020) Claw No.2</p>	
	<p>09950-70010 Handle Set</p>	
	<p>(09951-07100) Handle 100</p>	

PP

RECOMMENDED TOOLS

PP

	<p>09090-04020 Engine Sling Device</p>	<p>For suspending engine</p>
	<p>09200-00010 Engine Adjust Kit .</p>	
	<p>09258-00030 Hose Plug Set .</p>	<p>Plug for vacuum hose, fuel hose etc.</p>

EQUIPMENT

PP05-04

Abrasive compound	Valve
Caliper gauge	
CO/HC meter	
Compression gauge	
Connecting rod aligner	
Cylinder gauge	
Dial indicator	
Dye penetrant	
Engine tune-up tester	
Groove cleaning tool	Piston ring groove
Heater	
Magnetic finger	
Micrometer	
OBDII scan tool	
Pin hole grinder	Piston pin hole of piston
Piston ring compressor	
Piston ring expander	
Plastigage	
Precision straight edge	
Press	
Ridge reamer	Cylinder
Soft brush	
Solvent	
Spring tester	Valve spring
Steel square	Valve spring
Thermometer	
Torque wrench	
Torx wrench socket set	Stud bolt
Valve seat cutter	
V-block	
Vernier calipers	
Wire brush	Valve

PP

SSM (Special Service Materials)

08826-00080	Seat Packing Black or equivalent (FIPG)	
08826-00100	Seat Packing 1282B, THREE BOND 1282B or equivalent (FIPG)	
08833-00070	Adhesive 1324, THREE BOND 1324 or equivalent	

PP

EMISSION CONTROL EQUIPMENT

PP2V-65

Torque wrench	
Vacuum gauge	
Pressure gauge	
Hose clipper	









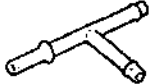

PP

SFI

SST (Special Service Tools)

PP8D-01

PP

	<p>09268-21010 Fuel Hose Puller</p>	
	<p>09268-41047 Injection Measuring Tool Set</p>	
	<p>(95336-08070) Hose</p>	
	<p>(09268-41250) T Joint</p>	
	<p>09268-45014 EFI Fuel Pressure Gauge</p>	
	<p>(09268-41200) Gauge</p>	
	<p>(09268-41220) Hose</p>	
	<p>(09268-41250) T Joint</p>	
	<p>09816-30010 Oil Pressure Switch Socket</p>	
	<p>09842-30080 EFI Inspection Wire "H"</p>	
	<p>09843-18020 Diagnosis Check Wire</p>	

RECOMMENDED TOOLS

PP02C-01

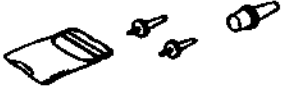
	<p>09082-00040 TOYOTA Electrical Tester.</p>	
	<p>09258-00030 Hose Plug Set.</p>	<p>Plug for vacuum hose, fuel hose etc.</p>

EQUIPMENT





Carburetor cleaner	Throttle body
Graduated cylinder	Injector
OBDII scan tool	
Soft brush	Throttle body
Sound scope	Injector
Torque wrench	
Vacuum gauge	

PP

COOLING

SST (Special Service Tools)

PP205-01

	<p>09230-01010 Radiator Service Tool Set</p>	
	<p>09231-14010 Punch</p>	
	<p>09960-10010 Variable Pin Wrench Set</p>	
	<p>(09963-00600) Pin 6</p>	
	<p>(09963-01000) Pin 10</p>	

RECOMMENDED TOOLS

	09082-00040 TOYOTA Electrical Tester.	
-----------------------------------------------------------------------------------	---------------------------------------	--

EQUIPMENT

PP18A-01

Heater	ECT switch, Thermostat
Radiator cap tester	
Thermometer	ECT switch, Thermostat
Torque wrench	
Vernier calipers	



COOLANT

Item	Capacity	Classification
Engine coolant		Ethylene-glycol base
1ZZ-FE:		
M/T	5.7 liters (6.0 US qts, 5.0 Imp. qts)	
A/T	5.6 liters (5.9 US qts, 4.9 Imp. qts)	
2ZZ-GE:		
M/T	5.9 liters (6.2 US qts, 5.2 Imp. qts)	
A/T	5.8 liters (6.1 US qts, 5.1 Imp. qts)	

LUBRICATION

SST (Special Service Tools)

PP200-01

	09228-06501 Oil Filter Wrench	
	09816-30010 Oil Pressure Switch Socket	

EQUIPMENT

Oil pressure gauge	
Torque wrench	
Feeler gauge	
Straight edge	

LUBRICANT

PP-17-05

Item	Capacity	Classification	
Engine oil			
Drain and refill	1ZZ-FE:	API grade SJ, Energy-Conserving or ILSAC multigrade engine oil. SAE 5W-30 is the best choice for your vehicle, for good fuel economy, and good starting in cold weather.	
	w/ Oil cooler		3.7 liters (3.9 US qts, 3.3 Imp.qts)
	w/o Oil cooler		3.5 liters (3.7 US qts, 3.1 Imp.qts)
	2ZZ-FE:		
	w/ Oil cooler		4.4 liters (4.8 US qts, 4.0 Imp.qts)
	w/o Oil cooler		4.2 liters (4.6 US qts, 3.8 Imp.qts)
Dry fill	1ZZ-FE:		
	2ZZ-GE:		



SSM (Special Service Materials)

<p>08833-00080 Adhesive 1344 THREE BOND 1344 LOCTITE 242 or equivalent</p>	<p>Oil pressure switch</p>
------------------------------------------------------------------------------------	----------------------------

IGNITION

RECOMMENDED TOOLS

PP09-02

	<p>09082-00040 TOYOTA Electrical Tester.</p>	
	<p>09200-00010 Engine Adjust Kit.</p>	



EQUIPMENT

Spark plug cleaner	
--------------------	--

STARTING

SST (Special Service Tools)

PP02A-02

	<p>09286-46011 Injection Pump Spine Shaft Puller</p>	
	<p>09810-38140 Starter Magnet Switch Nut Wrench 14</p>	
	<p>09820-00030 Alternator Rear Bearing Replacer</p>	

RECOMMENDED TOOLS

	09082-00040 TOYOTA Electrical Tester.	
-----------------------------------------------------------------------------------	---------------------------------------	--

EQUIPMENT









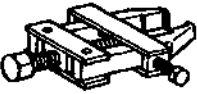

PROC-02

Dial indicator	Commutator
Magnetic finger	Steel ball
Press	Magnetic switch terminal kit part
Pull scale	Brush spring
Sandpaper	Commutator
Torque wrench	
V-block	Commutator
Vernier calipers	Commutator, Brush

CHARGING

SST (Special Service Tools)

PP24-61

	<p>09285-76010</p>	<p>Injection Pump Camshaft Bearing Cone Replacer</p>	
	<p>09286-46011</p>	<p>Injection Pump Spline Shaft Puller</p>	
	<p>09820-00021</p>	<p>Alternator Rear Bearing Puller</p>	
	<p>09820-00030</p>	<p>Alternator Rear Bearing Replacer</p>	
	<p>09820-63010</p>	<p>Alternator Pulley Set Nut Wrench Set</p>	
	<p>09950-60010</p>	<p>Replacer Set</p>	
	<p>(09951-00350)</p>	<p>Replacer 35</p>	
	<p>(09951-00530)</p>	<p>Replacer 53</p>	
	<p>09950-70010</p>	<p>Handle Set</p>	
	<p>(09951-07100)</p>	<p>Handle 100</p>	

RECOMMENDED TOOLS

PP02-01

	09082-00040 TOYOTA Electrical Tester.	
-----------------------------------------------------------------------------------	---------------------------------------	--



EQUIPMENT

Battery specific gravity gauge	Except maintenance free battery
Belt tension gauge	
Torque wrench	
Vernier callipers	Rotor (Slip ring), Brush

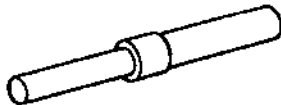

CLUTCH

SST (Special Service Tools)

FP002-02

	<p>09023-00100 Union Nut Wrench 10 mm</p>	<p>Clutch line</p>
	<p>09301-00210 Clutch Guide Tool</p>	
	<p>09333-00013 Clutch Diaphragm Spring Aligner</p>	

RECOMMENDED TOOLS

	09031-00030 Pin Punch .	
	09082-00040 TOYOTA Electrical Tester.	
	09905-00013 Snap Ring Pliers .	

EQUIPMENT

Form 1-02

Vernier calipers	
Dial indicator	
Torque wrench	













LUBRICANT













Item	Capacity	Classification
Brake fluid	-	SAE J1703 or FMVSS No. 116 DOT3





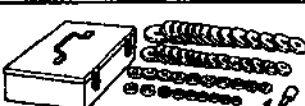

MANUAL TRANSAXLE (C56)

SST (Special Service Tools)







PP2A-01

	09223-50010	Crankshaft Front Oil Seal Replacer	Output shaft front bearing inner race
	09226-10010	Crankshaft Front & Rear Bearing Replacer	Transmission case oil seal
	09308-00010	Oil Seal Puller	Output shaft front bearing
	09309-12020	5th Driven Gear Replacer	
	09316-60011	Transmission & Transfer Bearing Replacer	Differential tapered roller bearing
	(09316-00011)	Replacer Pipe	
	09350-32014	TOYOTA Automatic Transmission Tool Set	Differential tapered roller bearing
	(09351-32120)	Overdrive Bearing Replacer	
	(09351-32140)	Oil Seal Replacer	
	09564-32011	Differential Preload Adaptor	
	09608-00071	Drive Pinion Rear Bearing Cone Replacer	Input shaft rear radial ball bearing Output shaft rear radial ball bearing
	09612-65014	Steering Worm Bearing Puller	Input shaft front bearing Differential tapered roller bearing outer race

	<p>09628-62011 Ball Joint Puller</p>	<p>5th driven gear</p>
	<p>09636-20010 Upper Ball Joint Dust Cover Replacer</p>	<p>No. 3 hub sleeve assembly</p>
	<p>09710-28021 Front Suspension Bushing Tool Set</p>	<p>Transaxle case oil seal</p>
	<p>(09710-08041) Bushing Replacer</p>	
	<p>09950-00020 Bearing Remover</p>	
	<p>09950-00030 Bearing Remover Attachment</p>	<p>Differential tapered roller bearing</p>
	<p>09950-30011 Puller A Set</p>	<p>No. 3 clutch hub</p>
	<p>09950-40011 Puller B Set</p>	<p>5th driven gear</p>
	<p>09950-60010 Replacer Set</p>	
	<p>(09951-00230) Replacer 23</p>	<p>5th driven gear</p>
	<p>(09951-00350) Replacer 35</p>	<p>Differential tapered roller bearing</p>
	<p>(09951-00360) Replacer 36</p>	<p>Input shaft front oil seal Differential tapered roller bearing</p>
	<p>(09951-00400) Replacer 40</p>	<p>Input shaft front bearing</p>

	<p>(09951-00560) Replacer 56</p>	<p>Output shaft front bearing</p>
	<p>09950-60020 Replacer Set No.2</p>	
	<p>(09951-00680) Replacer 68</p>	<p>Differential tapered roller bearing outer race (Transaxle case side)</p>
	<p>(09951-00710) Replacer 71</p>	<p>Differential tapered roller bearing outer race (Transmission case side)</p>
	<p>09950-70010 Handle Set</p>	
	<p>(09951-07150) Handle 150</p>	

RECOMMENDED TOOLS

	<p>09025-00010 Torque Wrench (30 kgf-cm)</p>	<p>Differential preload</p>
	<p>09031-00030 Pin Punch .</p>	
	<p>09040-00011 Hexagon Wrench Set .</p>	
	<p>09042-00010 Torx Socket T30 .</p>	
	<p>09090-04020 Engine Slng Device</p>	
	<p>09905-00012 Snap Ring No.1 Expander .</p>	

EQUIPMENT

PP-40-03

Dial indicator with magnetic base	
Feeler gauge	
Micrometer	
Torque wrench	
Magnetic finger	
Wooden block or similar object	

LUBRICANT

Item	Capacity	Classification
Manual transaxle oil (w/ Differential oil)	1.9 liters (2.0 US qts, 1.7 Imp. qts)	API GL-4 or GL-5 SAE 75W-90

SSM (Special Service Materials)









PP-37-01

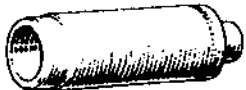
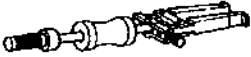
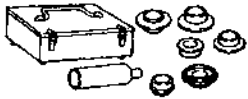
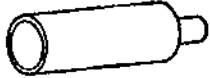





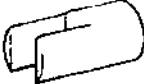





<p>08826-00090</p>	<p>Seal Packing 1281, THREE BOND 1281 or equivalent (FIG)</p>	<p>Transmission case x Transaxle case Transmission case x Transmission case cover</p>
<p>08833-00080</p>	<p>Adhesive 1344 THREE BOND 1344 LOCTITE 242 or equivalent</p>	













MANUAL TRANSAXLE (C60)









SST (Special Service Tools)

PP2E3-01

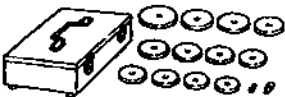





	09223-50010	Crankshaft Front oil Seal Replacer	Output shaft front bearing inner race
	09226-10010	Crankshaft Front & Rear Bearing Replacer	Transmission case oil seal
	09308-00010	Oil Seal Pulier	Output shaft front bearing
	09316-60011	Transmission & Transfer Bearing Replacer	Differential tapered roller bearing
	(09316-00011)	Replacer Pipe	
	09325-12010	Transmission Oil Plug	Input shaft rear radial ball bearing 6th driven gear
	09350-32014	TOYOTA Automatic Transmission Tool Set	Differential case tapered roller bearing
	(09351-32120)	Overdrive Bearing Replacer	
	(09351-32140)	Oil Seal Replacer	
	09517-12010	Rear Axle Shaft Oil Seal Replacer	Output shaft rear radial ball bearing Input shaft rear radial ball bearing
	09564-32011	Differential Preload Adaptor	
	09608-00071	Drive Pinion Rear Bearing Cone Replacer	Input shaft center radial ball bearing 4th driven gear and center radial ball bearing

	<p>09612-22011 Tilt Handle Bearing Replacer</p>	<p>No. 3 clutch hub assembly 5th driven gear</p>
	<p>09612-65014 Steering Worm Bearing Puller</p>	<p>Input shaft front bearing Differential tapered roller bearing outer race</p>
	<p>09710-28021 Front Suspension Bushing Tool Set</p>	<p>Transaxle case oil seal</p>
	<p>(09710-08041) Bushing Replacer</p>	
	<p>09950-00020 Bearing Remover</p>	
	<p>09950-00030 Bearing Remover Attachment</p>	
	<p>09950-30011 Puller A Set</p>	
	<p>(09951-03010) Upper Plate</p>	
	<p>(09953-03010) Center Bolt</p>	
	<p>(09954-03010) Arm</p>	
	<p>(09955-03021) Claw No.2</p>	
	<p>09950-40011 Puller B Set</p>	
	<p>(09951-04010) Hanger 150</p>	

	<p>(09952-04010) Slide Arm</p>	
	<p>(09953-04020) Center Bolt 150</p>	
	<p>(09953-04030) Center Bolt 200</p>	
	<p>(09954-04010) Arm 25</p>	
	<p>(09955-04021) Claw No.2</p>	
	<p>(09955-04061) Claw No.6</p>	
	<p>(09957-04010) Attachment</p>	
	<p>(09958-04011) Holder</p>	
	<p>09950-50012 Puller C Set</p>	<p>No. 3 clutch hub assembly</p>
	<p>(09954-05030) Claw No.3</p>	
	<p>09950-60010 Replacer Set</p>	
	<p>(09951-00180) Replacer 18</p>	<p>Transmission case bushing</p>
	<p>(09951-00350) Replacer 35</p>	<p>Differential tapered roller bearing</p>

	<p>(09951-00360) Replacer 36</p>	<p>Input shaft front oil seal</p>
	<p>(09951-00400) Replacer 40</p>	<p>Input shaft front bearing</p>
	<p>(09951-00560) Replacer 56</p>	<p>Output shaft front bearing</p>
	<p>09950-60020 Replacer Set No.2</p>	
	<p>(09951-00680) Replacer 68</p>	<p>Differential tapered roller bearing outer race (Transaxle case side)</p>
	<p>(09951-00710) Replacer 71</p>	<p>Differential tapered roller bearing outer race (transmission case side)</p>
	<p>09950-70010 Handle Set</p>	
	<p>(09951-07100) Handle 100</p>	
	<p>(09951-07150) Handle 150</p>	

RECOMMENDED TOOLS

	<p>09025-00010 Torque Wrench (30 kgf-cm)</p>	<p>Differential preload</p>
	<p>09031-00030 Pin Punch .</p>	
	<p>09040-00011 Hexagon Wrench Set .</p>	
	<p>09082-00040 TOYOTA Electrical Tester.</p>	
	<p>09090-04020 Engine Sling Device</p>	
	<p>09905-00012 Snap Ring No.1 Expander .</p>	
	<p>09905-00013 Snap Ring Pliers .</p>	

EQUIPMENT

PP55-02

Dial indicator with magnetic base	
Feeler gauge	
Micrometer	
Torque wrench	
Magnetic finger	
Wooden block or similar object	

LUBRICANT

Item	Capacity	Classification
Manual transaxle oil (w/ Differential oil)	2.3 liters (2.4 US qts, 2.0 Imp. qts)	API GL-4 or GL-5 SAE 75W-90











SSM (Special Service Materials)

PP2E4-01

08826-00090	Seal Packing 1281, THREE BOND 1281 or equivalent (FIG)	Transmission case x Transaxle case Transmission case x Transmission case cover
08833-00080	Adhesive 1344 THREE BOND 1344 LOCTITE 242 or equivalent	

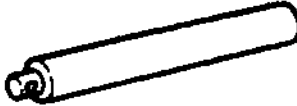

AUTOMATIC TRANSAXLE (U240E)**SST (Special Service Tools)**

PP200-01

	09308-00010 Oil Seal Puller	Side gear shaft oil seal
	09223-00010 Cover & Seal Replacer	
	09350-32014 TOYOTA Automatic Transmission Tool Set	
	(09351-32010) One-way Clutch Test Tool	
	(09351-32020) Stator Stopper	
	(09351-32150) Oil Seal Replacer	
	09950-70010 Handle Set	
	(09951-07150) Handle 150	
	09992-00095 Automatic Transmission Oil Pressure Gauge Set	Line pressure
	(09992-00231) Adaptor C	Line pressure
	(09992-00271) Gauge Assy	Line pressure

RECOMMENDED TOOLS

99001-01

	<p>09082-00040 TOYOTA Electrical Tester.</p>	
	<p>09090-04020 Engine Sling Device</p>	

EQUIPMENT

Straight edge	Torque converter clutch
Vernier calipers	Torque converter clutch
Dial indicator or dial indicator with magnetic base	Drive plate
Hexagon wrench (10 mm)	
Torque wrench	
OBDII scan tool	

LUBRICANT

PPSL-03

Item	Capacity	Classification
Automatic transaxle fluid		
Dry fill	7.6 liters (8.0 US qts, 6.7 Imp.qts)	ATF Type T-IV or equivalent
Drain and refill	4.1 liters (4.3 US qts, 3.6 Imp.qts)	









SSM (Special Service Materials)

<p>08833-00080 Adhesive 1344 THREE BOND 1344 LOCTITE 242 or equivalent</p>	
------------------------------------------------------------------------------------	--



AUTOMATIC TRANSAXLE (U341E)

SST (Special Service Tools)

PP25-01

	09308-00010 Oil Seal Puller	Side gear shaft oil seal
	09223-00010 Cover & Seal Replacer	
	09350-32014 TOYOTA Automatic Transmission Tool Set	
	(09351-32010) One-way Clutch Test Tool	
	(09351-32020) Stator Stopper	
	09992-00095 Automatic Transmission Oil Pressure Gauge Set	Line pressure
	(09992-00231) Adaptor C	Line pressure
	(09992-00271) Gauge Assy	Line pressure

RECOMMENDED TOOLS

	09082-00040 TOYOTA Electrical Tester.	
	09090-04020 Engine Sling Device	

EQUIPMENT

Straight edge	Torque converter clutch
Vernier calipers	Torque converter clutch
Dial indicator or dial indicator with magnetic base	Drive plate
Hexagon wrench (10 mm)	
Torque wrench	
OBDII scan tool	
Punch	

LUBRICANT

Item	Capacity	Classification
Automatic transaxle fluid Dry fill Drain and refill	6.9 liters (7.3 US qts, 6.0 Imp.qts) 2.9 liters (3.1 US qts, 2.6 Imp.qts)	ATF Type T-IV or equivalent

SSM (Special Service Materials)











PP209-01

<p>08833-00080 Adhesive 1344 THREE BOND 1344 LOCTITE 242 or equivalent</p>	
------------------------------------------------------------------------------------	--



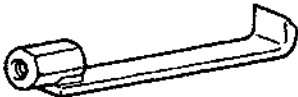







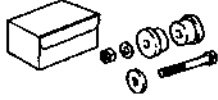

SUSPENSION AND AXLE

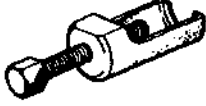
SST (Special Service Tools)













PP202-01

	09214-76011	Crankshaft Pulley Replacer	Rear axle
	09240-00020	Wire Gauge Set	Front drive shaft
	09506-35010	Differential Drive Pinion Rear Bearing Replacer	Front drive shaft
	09520-00031	Rear Axle Shaft Puller	
	(09520-00040)	Shocker	Front axle Rear axle
	(09521-00010)	Attachment	Front axle
	(09521-00020)	Rod with Grip	Front axle Rear axle
	09520-01010	Drive Shaft Remover Attachment	Front drive shaft
	09520-24010	Differential Side Gear Shaft Puller	Front drive shaft
	(09520-32040)	Shocker Set	
	09521-24010	Drive Shaft Boot Clamping Tool	Front drive shaft
	09527-17011	Rear Axle Shaft Bearing Remover	Front axle

PREPARATION - SUSPENSION AND AXLE





	<p>09555-55010 Differential Drive Pinion Bearing Replacer</p>	<p>Front axle</p>
	<p>09608-16042 Front Hub Bearing Adjusting Tool</p>	<p>Front drive shaft</p>
	<p>(09608-02021) Bolt & Nut</p>	
	<p>(09608-02041) Retainer</p>	
	<p>09608-32010 Steering Knuckle Oil Seal Replacer</p>	<p>Front axle</p>
	<p>09610-20012 Pitman Arm Puller</p>	<p>Front axle Front drive shaft Front suspension</p>
	<p>09628-10011 Ball Joint Puller</p>	<p>Front axle Rear axle</p>
	<p>09628-62011 Ball Joint Puller</p>	<p>Front axle Front suspension</p>
	<p>09710-30021 Suspension Bushing Tool Set</p>	<p>Front drive shaft</p>
	<p>(09710-03141) Bushing Remover Base</p>	
	<p>09727-30021 Coil Spring Compressor</p>	<p>Front suspension Rear suspension</p>
	<p>(09727-00010) Bolt Set</p>	
	<p>(09727-00021) Arm Set</p>	

PREPARATION - SUSPENSION AND AXLE

	<p>(09727-00031) Compressor</p>	
	<p>09729-22031 Front Spring Upper Seat Holder</p>	<p>Front suspension</p>
	<p>09930-00010 Drive Shaft Nut Chisel</p>	<p>Front axle Front drive shaft</p>
	<p>09950-00020 Bearing Remover</p>	<p>Front drive shaft Rear axle</p>
	<p>09950-60010 Replacer Set</p>	
	<p>(09951-00380) Replacer 38</p>	<p>Front axle</p>
	<p>(09951-00550) Replacer 55</p>	<p>Front axle</p>
	<p>(09951-00650) Replacer 65</p>	<p>Front axle Front drive shaft</p>
	<p>09950-60020 Replacer Set No. 2</p>	<p>Front axle</p>
	<p>(09951-00730) Replacer 73</p>	
	<p>09950-70010 Handle Set</p>	<p>Front axle Front drive shaft</p>
	<p>(09951-07150) Handle 150</p>	

RECOMMENDED TOOLS

PP20-01

	<p>09025-00010 Torque Wrench (30 kgf-cm)</p>	
	<p>09042-00010 Torx Socket T30 .</p>	
	<p>09090-04020 Engine Sling Device</p>	
	<p>09905-00012 Snap Ring No.1 Expander .</p>	
	<p>09905-00013 Snap Ring Pliers .</p>	

EQUIPMENT

Dial indicator with magnetic base	
Drill	
Torque wrench	

LUBRICANT













PP017-03

Drive shaft joint grease	Capacity	Application
1ZZ-FE (A/T): Outboard side Color=Yellow ochre Inboard side Color=Yellow ochre	110 - 120 g (3.9 - 4.2 oz.) 180 - 190 g (6.3 - 6.7 oz.)	
1ZZ-FE (MT) and 2ZZ-GE: Outboard side Color=Black Inboard side Color=Gray	115 - 135 g (4.1 - 4.8 oz.) 100 - 120 g (3.5 - 4.2 oz.)	



BRAKE

SST (Special Service Tools)



PP2D-01

	09023-00100	Union Nut Wrench 10 mm	
	09214-76011	Crankshaft Pulley Replacer	
	09520-00031	Rear Axle Shaft Puller	
	(09520-00040)	Shocker	
	(09521-00020)	Rod with Grip	
	09950-00020	Bearing Remover	
	09703-30010	Brake Shoe Return Spring Tool	
	09709-29018	LSPV Gauge Set	
	09718-00010	Shoe Hold Down Spring Driver	
	09751-36011	Brake Line Union Nut 10 x 12 mm Wrench	
	09843-18040	Diagnosis Check Wire No.2	
	09990-00150	ABS Actuator Checker and Sub-harness	

PREPARATION - BRAKE

	<p>09990-00250 ABS Actuator Checker Sub-harness "G"</p>	
	<p>09990-00300 ABS Actuator Checker Sub-harness "I"</p>	
	<p>09990-00360 ABS Actuator Checker Sub-harness "L"</p>	

RECOMMENDED TOOLS

	09082-00040 TOYOTA Electrical Tester.	
	09905-00013 Snap Ring Pliers .	Master cylinder

EQUIPMENT

PP-65-02

Torque wrench	
Micrometer	Brake disc
Dial indicator	Brake disc
Vernier calipers	Brake disc
Brake drum gauge	











LUBRICANT

Item	Capacity	Classification
Brake fluid	-	SAE J1703 or FMVSS No. 116 DOT 3



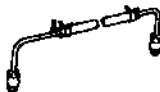

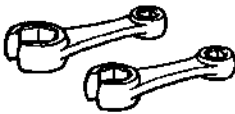







STEERING



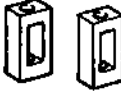





SST (Special Service Tools)

PP26K-01







	09608-04031	Front Hub Inner Bearing Cone Replacer	Tilt steering column
	09612-00012	Rack & Pinion Steering Rack Housing Stand	PS gear
	09612-20010	Power Steering Oil Seal Puller	PS gear
	09612-22011	Tilt Handle Bearing Replacer	PS gear
	09616-00010	Steering Worm Bearing Adjusting Socket	PS gear
	09617-35020	Power Steering Ring Nut Wrench	PS gear
	09631-12071	Steering Rack Oil Seal Test Tool	PS gear
	09631-20051	Steering Rack Cover "C"	PS gear
	09631-20081	Seal Ring Tool	PS gear
	09631-22020	Power Steering Hose Nut 14 x 17 mm Wrench Set	PS vane pump PS gear
	09633-00020	Power Steering Hose Nut Wrench	PS gear
	09640-10010	Power Steering Pressure Gauge Set	Power steering fluid

PREPARATION - STEERING

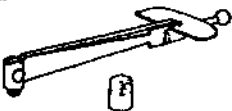
	<p>(09641-01010) Gauge Assy</p>	
	<p>(09641-01030) Attachment B</p>	
	<p>(09641-01060) Attachment E</p>	
	<p>09922-10010 Variable Open Wrench</p>	<p>PS gear</p>
	<p>09950-50012 Puller C Set</p>	<p>Tilt steering column</p>
	<p>(09951-05010) Hanger 150</p>	
	<p>(09952-05010) Slide Arm</p>	
	<p>(09953-05020) Center Bolt 150</p>	
	<p>(09954-05020) Claw No.2</p>	
	<p>09950-60010 Replacer Set</p>	
	<p>(09951-00210) Replacer 21</p>	<p>PS gear</p>
	<p>(09951-00240) Replacer 24</p>	<p>PS gear</p>
	<p>(09951-00280) Replacer 28</p>	<p>PS vane pump PS gear</p>

	<p>(09951-00340) Replacer 34</p>	<p>PS gear</p>
	<p>(09951-00350) Replacer 35</p>	<p>PS gear</p>
	<p>(09951-00400) Replacer 40</p>	<p>PS gear</p>
	<p>(09952-06010) Adapter</p>	<p>PS gear</p>
	<p>09950-70010 Handle Set</p>	
	<p>(09951-07100) Handle 100</p>	<p>PS vane pump PS gear</p>
	<p>(09951-07150) Handle 150</p>	<p>PS gear</p>
	<p>(09951-07200) Handle 200</p>	<p>PS gear</p>
	<p>(09951-07360) Handle 360</p>	<p>PS gear</p>

RECOMMENDED TOOLS

	<p>09025-00010 Torque Wrench (30 kgf-cm)</p>	<p>PS vane pump PS gear</p>
	<p>09042-00010 Torx Socket T30 .</p>	<p>Tilt steering column</p>
	<p>09904-00010 Expander Set .</p>	
	<p>(09904-00050) No. 4 Claw</p>	
	<p>09905-00012 Snap Ring No.1 Expander .</p>	
	<p>09905-00013 Snap Ring Pliers .</p>	

EQUIPMENT

PROB-02

Caliper gauge	PS vane pump
Vernier Calipers	PS vane pump
Dial indicator	PS gear
Feeler gauge	PS vane pump
Micrometer	PS vane pump
Torque wrench	

LUBRICANT

Item	Capacity	Classification
Power steering fluid Total	1.0 liters (1.1 US qts, 0.9 Imp.qts)	ATF DEXRON® II or III

SSM (Special Service Materials)





PP1W-01

08833-00080 Adhesive 1344 THREE BOND 1344 LOCTITE 242 or equivalent	PS gear
---------------------------------------------------------------------------	---------

SUPPLEMENTAL RESTRAINT SYSTEM





PP040-01

SST (Special Service Tools)

	09082-00700	SRS Airbag Deployment Tool	
	09082-00750	Airbag Deployment Wire Sub-harness No.3	
	09082-00760	Airbag Deployment Wire Sub-harness No.4	
	09843-18020	Diagnosis Check Wire	

RECOMMENDED TOOLS

PP1K-03

	<p>09042-00020 Torx Socket T40 .</p>	<p>Airbag sensor assembly</p>
	<p>09082-00050 TOYOTA Electrical Tester Set.</p>	
	<p>09082-00040 TOYOTA Electrical Tester.</p>	
	<p>(09083-00150) Test Lead Set</p>	

EQUIPMENT

Torque wrench	
Bolt: Length: 35 mm (1.38 in.) Pitch: 1.0 mm (0.039 in.) Diam.: 6.0 mm (0.236 in.)	Airbag disposal
Tire Width: 185 mm (7.28 in.) Inner diam.: 360mm (14.17 in.)	Airbag disposal
Tire with disc wheel Width: 185 mm (7.28 in.) Inner diam.: 360 mm (14.17 in.)	Airbag disposal
Vinyl bag	Airbag disposal



BODY ELECTRICAL

SST (Special Service Tools)

PROXY-01

	09843-18020 Diagnosis Check Wire
-----------------------------------------------------------------------------------	----------------------------------

RECOMMENDED TOOLS

	<p>09082-00040 TOYOTA Electrical Tester.</p>	
	<p>09041-00030 Torx Driver T30 .</p>	<p>For removing and installing steering wheel pad</p>
	<p>09042-00010 Torx Socket T30 .</p>	<p>For removing and installing steering wheel pad</p>

EQUIPMENT



PP01A-01

Voltmeter	
Ammeter	
Ohmmeter	
Test lead	
Syphon	Brake fluid level warning switch
Bulb (3.4 W)	Fuel sender gauge
Bulb (21 W)	Turn signal flasher relay
Dry cell battery	Fuel sender gauge
Torque wrench	
Masking tape	Rear window defogger wire
Tin foil	Rear window defogger wire

BODY





PP20J-01

SST (Special Service Tools)

	09082-00700 SRS Airbag Deployment Tool	
	09082-00740 Airbag Deployment Wire Sub-harness No.2	
	09812-00010 Door Hinge Set Bolt Wrench	

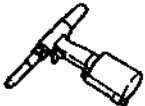
RECOMMENDED TOOLS

PP20K-01

	<p>09050-20010 Air Riveter.</p>	
	<p>(09050-02010) Dust Cap.</p>	
	<p>(09050-02030) Nose Piece No.2.</p>	
	<p>09060-60350 Rivet Cutter.</p>	

EQUIPMENT

Clip remover	
Torque wrench	
Hog ring pliers	
Tape	To avoid surface damage
Adhesive tape	To avoid surface damage
Double - stick tape	
Adhesive	
Cleaner	
Shop rag	Regulator handle
Knife	Moulding
Heat light	Moulding
Piano wire	Windshield
Sealer gun	
Brush	
Putty spatula	
Wooden block or similar object	For tying both piano wire ends
Plastic sheet	To avoid surface damage
Rope (no projections, difficult to break)	Seat belt pretensioner disposal
Tire Width: 185 mm (7.28 in.) Inner diam: 360 mm (14.17 in.)	Seat belt pretensioner disposal
Tire with disc wheel Width: 185 mm (7.28 in.) Inner diam 360 mm (14.17 in.)	Seat belt pretensioner disposal
Vinyl bag	Seat belt pretensioner disposal

LUBRICANT

PPOMX-02

Item	Capacity	Classification
MP grease	-	-











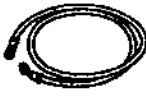

SSM (Special Service Materials)

08833-00070	Adhesive 1324, THREE BOND 1324 or equivalent	
08833-00030	Three cement black or equivalent	
08850-00801	Windshield Glass Adhesive Set or equivalent	



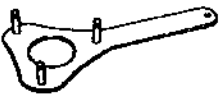

AIR CONDITIONING

SST (Special Service Tools)

PP04-01



	07110-58060	Air Conditioner Service Tool Set	
	(07117-78050)	Refrigerant Charging Gauge	
	(07117-88060)	Refrigerant Charging Hose	Discharge (Red)
	(07117-88070)	Refrigerant Charging Hose	Suction (Blue)
	(07117-88080)	Refrigerant Charging Hose	Utility (Green)
	(07117-58060)	Refrigerant Drain Service Valve	
	(07117-58080)	Quick Disconnect Adapter	Discharge (diam. 16 mm)
	(07117-58090)	Quick Disconnect Adapter	Suction (diam. 13 mm)
	(07117-58070)	T-Joint	
	07116-38360	Gas Leak Detector Assembly	
	07112-76060	Magnetic Clutch Stopper	
	07112-66040	Magnetic Clutch Remover	

PREPARATION -- AIR CONDITIONING

	07114-84020	Snap Ring Pliers	
	07114-84010	Snap Ring Pliers	
	09870-00015	A/C Quick Joint Puller No.1	Suction tube
	09870-00025	A/C Quick Joint Puller No.2	Liquid tube

RECOMMENDED TOOLS

PP17X-01

	<p>09082-00040 TOYOTA Electrical Tester.</p>	
	<p>09216-00021 Belt Tension Gauge .</p>	
	<p>09216-00030 Belt Tension Gauge Cable .</p>	

EQUIPMENT

Voltmeter	
Ammeter	
Ohmmeter	
Test lead	
Thermometer	Thermistor, ECT switch
Torque wrench	
Dial indicator	Magnetic clutch
Plastic hammer	Magnetic clutch

LUBRICANT

PP177-02

Item	Capacity	Classification
Compressor oil	--	ND-OIL 8 or equivalent
When replacing condenser	40 cc (1.4 fl.oz.)	
When replacing evaporator	40 cc (1.4 fl.oz.)	
When replacing compressor	120 cc (4.1 fl.oz.)	

SERVICE SPECIFICATIONS













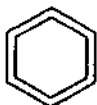
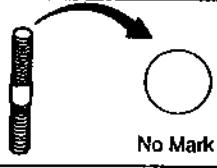
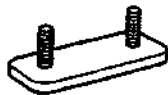













STANDARD BOLT	SS-1
MAINTENANCE	SS-4
ENGINE MECHANICAL	SS-6
EMISSION CONTROL	SS-16
SFI	SS-17
COOLING	SS-19
LUBRICATION	SS-21
IGNITION	SS-23
STARTING	SS-25
CHARGING	SS-27
CLUTCH	SS-29
MANUAL TRANSAXLE (C56)	SS-31
MANUAL TRANSAXLE (C60)	SS-36
AUTOMATIC TRANSAXLE (U240E)	SS-41
AUTOMATIC TRANSAXLE (U341E)	SS-43
SUSPENSION AND AXLE	SS-45
BRAKE	SS-49
STEERING	SS-51
SUPPLEMENTAL RESTRAINT SYSTEM ...	SS-53
BODY ELECTRICAL	SS-54
BODY	SS-55
AIR CONDITIONING	SS-57

SS

STANDARD BOLT

HOW TO DETERMINE BOLT STRENGTH

SS025-C1

Bolt Type				Class
Hexagon Head Bolt		Stud Bolt	Weld Bolt	
Normal Recess Bolt	Deep Recess Bolt			
  No Mark	 No Mark	 No Mark		4T
 				5T
  w/ Washer	 w/ Washer			6T
 	 			7T
		 		8T
				9T
	 			10T
	 			11T























SS

SPECIFIED TORQUE FOR STANDARD BOLTS

Class	Diameter mm	Pitch mm	Specified torque					
			Hexagon head bolt			Hexagon flange bolt		
			N·m	kgf·cm	ft·lbf	N·m	kgf·cm	ft·lbf
4T	6	1	5	55	48 in·lbf	6	60	52 in·lbf
	8	1.25	12.5	130	9	14	145	10
	10	1.25	26	260	19	29	290	21
	12	1.25	47	480	35	53	540	39
	14	1.5	74	760	55	84	850	61
	16	1.5	115	1,150	83	--	--	--
5T	6	1	6.5	65	56 in·lbf	7.5	75	65 in·lbf
	8	1.25	15.5	160	12	17.5	175	13
	10	1.25	32	330	24	36	360	26
	12	1.25	59	600	43	65	670	48
	14	1.5	91	930	67	100	1,050	76
	16	1.5	140	1,400	101	--	--	--
6T	6	1	8	80	69 in·lbf	9	90	78 in·lbf
	8	1.25	19	195	14	21	210	15
	10	1.25	39	400	29	44	440	32
	12	1.25	71	730	53	80	810	59
	14	1.5	110	1,100	80	125	1,250	90
	16	1.5	170	1,750	127	--	--	--
7T	6	1	10.5	110	8	12	120	9
	8	1.25	25	260	19	28	290	21
	10	1.25	52	530	38	58	590	43
	12	1.25	95	970	70	105	1,050	76
	14	1.5	145	1,500	108	165	1,700	123
	16	1.5	230	2,300	166	--	--	--
8T	8	1.25	29	300	22	33	330	24
	10	1.25	61	620	45	68	690	50
	12	1.25	110	1,100	80	120	1,250	90
9T	8	1.25	34	340	25	37	380	27
	10	1.25	70	710	51	78	790	57
	12	1.25	125	1,300	94	140	1,450	105
10T	8	1.25	38	390	28	42	430	31
	10	1.25	78	800	58	88	890	64
	12	1.25	140	1,450	105	155	1,600	116
11T	8	1.25	42	430	31	47	480	35
	10	1.25	87	890	64	97	990	72
	12	1.25	155	1,600	116	175	1,800	130

SS

HOW TO DETERMINE NUT STRENGTH

Present Standard Hexagon Nut	Nut Type		Class
	Old Standard Hexagon Nut		
	Cold Forging Nut	Cutting Processed Nut	
 No Mark			4N
 No Mark (w/ Washer)	 No Mark (w/ Washer)	 No Mark	5N (4T)
  			6N
	 	 	7N (5T)
 			8N
 	 	 No Mark	10N (7T)
 			11N
 			12N

*: Nut with 1 or more marks on one side surface of the nut.

HINT:

B06432

Use the nut with the same number of the nut strength classification or the greater than the bolt strength classification number when tightening parts with a bolt and nut.

Example: Bolt = 4T

Nut = 4N or more

SS

MAINTENANCE

SERVICE DATA

SS04G-01

Front axle and suspension Ball joint vertical play	Maximum	0 mm (0 in.)
-------------------------------------------------------	---------	--------------

SS

TORQUE SPECIFICATION

SS0481-02

Part tightened		N-m	kgf-cm	ft-lbf
Front seat x Body		37	375	27
Front suspension member x Body (See page MA-7)	Bolt A	113	1,152	83
	Bolt B	157	1,600	116
Rear suspension member x Body (See page MA-7)	Bolt A	80	816	59
	Bolt B	130	1,326	96

ENGINE MECHANICAL

SERVICE DATA

SS04-01

Compression pressure	1ZZ-FE:	at 250 rpm STD	1,500 kPa (15.3 kgf/cm ² , 218 psi)
		Minimum	1,000 kPa (10.2 kgf/cm ² , 145 psi)
	Difference of pressure between each cylinder		100 kPa (1.0 kgf/cm ² , 15 psi) or less
	2ZZ-GE:	at 250 rpm STD	1,400 kPa (14.3 kgf/cm ² , 203 psi)
		Minimum	1,000 kPa (10.2 kgf/cm ² , 145 psi)
	Difference of pressure between each cylinder		110 kPa (1.1 kgf/cm ² , 16 psi) or less
Valve clearance	1ZZ-FE:	at cold Intake	0.15 – 0.25 mm (0.006 – 0.010 in.)
		Exhaust	0.25 – 0.35 mm (0.010 – 0.014 in.)
	Valve clearance adjusting shim		
		No. 06	5.060 mm (0.1992 in.)
		No. 08	5.080 mm (0.2000 in.)
		No. 10	5.100 mm (0.2008 in.)
		No. 12	5.120 mm (0.2016 in.)
		No. 14	5.140 mm (0.2024 in.)
		No. 16	5.160 mm (0.2031 in.)
		No. 18	5.180 mm (0.2039 in.)
		No. 20	5.200 mm (0.2047 in.)
		No. 22	5.220 mm (0.2055 in.)
		No. 24	5.240 mm (0.2063 in.)
		No. 26	5.260 mm (0.2071 in.)
		No. 28	5.280 mm (0.2079 in.)
		No. 30	5.300 mm (0.2087 in.)
		No. 32	5.320 mm (0.2094 in.)
		No. 34	5.340 mm (0.2102 in.)
		No. 36	5.360 mm (0.2110 in.)
		No. 38	5.380 mm (0.2118 in.)
		No. 40	5.400 mm (0.2126 in.)
		No. 42	5.420 mm (0.2134 in.)
		No. 44	5.440 mm (0.2142 in.)
		No. 46	5.460 mm (0.2150 in.)
		No. 48	5.480 mm (0.2157 in.)
		No. 50	5.500 mm (0.2165 in.)
		No. 52	5.520 mm (0.2173 in.)
		No. 54	5.540 mm (0.2181 in.)
		No. 56	5.560 mm (0.2189 in.)
		No. 58	5.580 mm (0.2197 in.)
		No. 60	5.600 mm (0.2205 in.)
		No. 62	5.620 mm (0.2213 in.)
		No. 64	5.640 mm (0.2220 in.)
		No. 66	5.660 mm (0.2228 in.)
		No. 68	5.680 mm (0.2236 in.)
		No. 70	5.700 mm (0.2244 in.)
		No. 72	5.720 mm (0.2252 in.)
		No. 74	5.740 mm (0.2260 in.)

SS

Valve clearance	2ZZ-GE:	at cold Intake	0.15 - 0.25 mm (0.006 - 0.010 in.)
		Exhaust	0.35 - 0.45 mm (0.014 - 0.018 in.)
	Valve clearance adjusting shim	No. 00	2.000 mm (0.0787 in.)
		No. 02	2.020 mm (0.0795 in.)
		No. 04	2.040 mm (0.0803 in.)
		No. 06	2.060 mm (0.0811 in.)
		No. 08	2.080 mm (0.0819 in.)
		No. 10	2.100 mm (0.0827 in.)
		No. 12	2.120 mm (0.0835 in.)
		No. 14	2.140 mm (0.0843 in.)
		No. 16	2.160 mm (0.0850 in.)
		No. 18	2.180 mm (0.0858 in.)
		No. 20	2.200 mm (0.0866 in.)
		No. 22	2.220 mm (0.0874 in.)
		No. 24	2.240 mm (0.0882 in.)
		No. 26	2.260 mm (0.0890 in.)
		No. 28	2.280 mm (0.0898 in.)
		No. 30	2.300 mm (0.0906 in.)
		No. 32	2.320 mm (0.0913 in.)
		No. 34	2.340 mm (0.0921 in.)
		No. 36	2.360 mm (0.0929 in.)
		No. 38	2.380 mm (0.0937 in.)
		No. 40	2.400 mm (0.0945 in.)
		No. 42	2.420 mm (0.0953 in.)
		No. 44	2.440 mm (0.0961 in.)
		No. 46	2.460 mm (0.0969 in.)
		No. 48	2.480 mm (0.0976 in.)
		No. 50	2.500 mm (0.0984 in.)
		No. 52	2.520 mm (0.0992 in.)
	No. 54	2.540 mm (0.1000 in.)	
	No. 56	2.560 mm (0.1008 in.)	
	No. 58	2.580 mm (0.1016 in.)	
	No. 60	2.600 mm (0.1024 in.)	
	No. 62	2.620 mm (0.1031 in.)	
	No. 64	2.640 mm (0.1039 in.)	
	No. 66	2.660 mm (0.1047 in.)	
	No. 68	2.680 mm (0.1055 in.)	
	No. 70	2.700 mm (0.1063 in.)	
	No. 72	2.720 mm (0.1071 in.)	
	No. 74	2.740 mm (0.1079 in.)	
	No. 76	2.760 mm (0.1087 in.)	
	No. 78	2.780 mm (0.1094 in.)	
	No. 80	2.800 mm (0.1102 in.)	
Ignition timing	1ZZ-FE:		10 - 18° BTDC @ idle
	2ZZ-GE:		8 - 12° BTDC @ idle
Idle speed	1ZZ-FE:	M/T	700 ± 50 rpm
		A/T	750 ± 50 rpm
	2ZZ-GE:	M/T	800 ± 50 rpm
		A/T	750 ± 50 rpm
Chain and timing sprocket	Chain length at 16 links	Maximum	122.6 mm (4.827 in.)
	Camshaft timing sprocket wear (w/ chain)	Minimum	97.3 mm (3.831 in.)
	Crankshaft timing sprocket wear (w/ chain)	Minimum	51.6 mm (2.031 in.)
Chain tensioner slipper and vibration damper	Wear	Maximum	1.0 mm (0.039 in.)

SS

SS

Cylinder head	Warpage	Maximum	0.05 mm (0.0020 in.)
	Valve seat Refacing angle		30°, 45°, 75°
	Contacting angle		45°
	Contacting width		1.0 - 1.4 mm (0.039 - 0.055 in.)
	Residuary width	Minimum Intake	3.3 mm (0.130 in.)
		Exhaust	3.2 mm (0.126 in.)
	Valve guide bushing bore diameter	1ZZ-FE	
		STD	10.285 - 10.306 mm (0.4049 - 0.4057 in.)
		O/S 0.05	10.335 - 10.356 mm (0.4068 - 0.4077 in.)
		2ZZ-GE	
		STD	10.488 - 10.506 mm (0.41291 - 0.41362 in.)
		O/S 0.05	10.538 - 10.556 mm (0.41488 - 0.41559 in.)
	Cylinder head bolt diameter	at tension portion STD	9.0 - 9.2 mm (0.354 - 0.362 in.)
		Minimum	9.0 mm (0.354 in.)
Valve guide bushing	1ZZ-FE:		
	Inside diameter		5.510 - 5.530 mm (0.2169 - 0.2177 in.)
	Protrusion height		8.7 - 9.1 mm (0.342 - 0.358 in.)
	2ZZ-GE:		
	Inside diameter		5.500 - 5.518 mm (0.2165 - 0.2172 in.)
	Protrusion height		15.3 - 15.7 mm (0.602 - 0.618 in.)
Valve	1ZZ-FE:		
	Valve overall length	STD Intake	88.65 mm (3.4902 in.)
		Exhaust	88.69 mm (3.4917 in.)
		Minimum Intake	88.35 mm (3.4783 in.)
		Exhaust	88.39 mm (3.4799 in.)
	Valve face angle		44.5°
	Stem diameter	Intake	5.470 - 5.485 mm (0.2154 - 0.2159 in.)
		Exhaust	5.465 - 5.480 mm (0.2152 - 0.2157 in.)
	Stem oil clearance	STD Intake	0.025 - 0.060 mm (0.0010 - 0.0024 in.)
		Exhaust	0.030 - 0.065 mm (0.0012 - 0.0026 in.)
		Maximum Intake	0.08 mm (0.0031 in.)
		Exhaust	0.10 mm (0.0039 in.)
	Margin thickness	STD	1.0 mm (0.039 in.)
		Minimum	0.7 mm (0.028 in.)
	2ZZ-GE:		
	Valve overall length	STD Intake	111.3 mm (4.382 in.)
		Exhaust	111.7 mm (4.398 in.)
		Minimum Intake	110.9 mm (4.366 in.)
		Exhaust	111.3 mm (4.382 in.)
	Valve face angle		44.5°
Stem diameter	Intake	5.480 - 5.475 mm (0.21496 - 0.21555 in.)	
	Exhaust	5.445 - 5.470 mm (0.21437 - 0.21535 in.)	
Stem oil clearance	STD Intake	0.025 - 0.058 mm (0.00098 - 0.00228 in.)	
	Exhaust	0.030 - 0.063 mm (0.00118 - 0.00248 in.)	
	Maximum	0.10 mm (0.0039 in.)	
	STD	1.0 mm (0.039 in.)	
Minimum		0.7 mm (0.028 in.)	

SERVICE SPECIFICATIONS — ENGINE MECHANICAL

Valve spring	1ZZ-FE:			
	Deviation	Maximum	1.6 mm (0.063 in.)	
	Angle (Reference)	Maximum	2°	
	Free length		45.90 mm (1.807 in.)	
	Installed tension at 33.6 mm (1.323 in.)		139.6 – 154.4 N (14.2 – 15.8 kgf, 31.3 – 34.8 lbf)	
	Maximum working tension at 24.6 mm (0.969 in.)		244.9 – 276.1 N (25.5 – 28.1 kgf, 56.2 – 61.9 lbf)	
	2ZZ-GE:			
	Deviation	Maximum	1.6 mm (0.063 in.)	
	Angle (Reference)	Maximum	2°	
	Free length	Intake	46.4 mm (1.830 in.)	
		Exhaust	46.5 mm (1.831 in.)	
	Installed tension at 38.5 mm (1.516 in.)	Intake	220.2 – 243.8 N (22.5 – 24.7 kgf, 49.6 – 55.5 lbf)	
		Exhaust	208.2 – 229.8 N (21.2 – 23.4 kgf, 47.6 – 52.6 lbf)	
	Maximum working tension	Intake at 27.3 mm (1.075 in.)	533 – 589 N (54.4 – 60.1 kgf, 119.9 – 132.5 lbf)	
		Exhaust at 28.5 mm (1.122 in.)	495.5 – 548.5 N (50.5 – 55.9 kgf, 111.3 – 123.3 lbf)	
Valve lifter	1ZZ-FE:			
	Lifter diameter		30.966 – 30.976 mm (1.2191 – 1.2195 in.)	
	Lifter bore diameter		31.000 – 31.025 mm (1.2205 – 1.2215 in.)	
	Oil clearance	STD	0.024 – 0.059 mm (0.0009 – 0.0023 in.)	
		Maximum	0.079 mm (0.0031 in.)	
Camshaft	1ZZ-FE:			
	Thrust clearance	STD	0.040 – 0.095 mm (0.0016 – 0.0037 in.)	
		Maximum	0.11 mm (0.0043 in.)	
	Journal oil clearance	STD	0.035 – 0.072 mm (0.0014 – 0.0028 in.)	
		Maximum	0.10 mm (0.0039 in.)	
	Journal diameter	No. 1	34.449 – 34.465 mm (1.3563 – 1.3569 in.)	
		Others	22.949 – 22.965 mm (0.9035 – 0.9041 in.)	
	Circle runout	Maximum	0.03 mm (0.0012 in.)	
	Cam lobe height	STD Intake	44.333 – 44.433 mm (1.7454 – 1.7493 in.)	
		Exhaust	43.761 – 43.861 mm (1.7229 – 1.7268 in.)	
		Minimum Intake	44.18 mm (1.7394 in.)	
		Exhaust	43.61 mm (1.7169 in.)	
		2ZZ-GE:		
	Thrust clearance	STD	0.04 – 0.14 mm (0.0016 – 0.0055 in.)	
		Maximum	0.15 mm (0.0059 in.)	
	Journal oil clearance	STD		
		No. 1	0.035 – 0.076 mm (0.00138 – 0.00299 in.)	
		Others	0.035 – 0.072 mm (0.00138 – 0.00283 in.)	
		Maximum	0.1 mm (0.039 in.)	
	Journal diameter	No. 1	34.449 – 34.465 mm (1.35626 – 1.35689 in.)	
		Others	27.949 – 27.965 mm (1.10035 – 1.10098 in.)	
	Circle runout	Maximum	0.03 mm (0.0012 in.)	
Cam lobe height	STD Intake			
	No. 1	40.607 – 40.707 mm (1.59586 – 1.59979 in.)		
	No. 2	38.769 – 38.869 mm (1.52362 – 1.52755 in.)		
	Exhaust			
	No. 1	40.019 – 40.119 mm (1.57275 – 1.57668 in.)		
	No. 2	38.863 – 38.963 mm (1.52732 – 1.53125 in.)		
	Minimum Intake			
	No. 1	40.45 mm (1.5925 in.)		
	No. 2	38.61 mm (1.5201 in.)		
	Exhaust			
	No. 1	39.86 mm (1.5693 in.)		
	No. 2	38.71 mm (1.5240 in.)		
Intake manifold	Warpage	Maximum	0.10 mm (0.0039 in.)	
Exhaust manifold	Warpage	Maximum	0.70 mm (0.0276 in.)	

SERVICE SPECIFICATIONS - ENGINE MECHANICAL

Connecting rod	1ZZ-FE:		
	Thrust clearance	STD	0.160 - 0.342 mm (0.0063 - 0.0135 in.)
		Maximum	0.342 mm (0.0135 in.)
	Connecting rod thickness		19.788 - 19.840 mm (0.7791 - 0.7811 in.)
	Connecting rod bearing center wall thickness		
	Reference	Mark 1	1.486 - 1.490 mm (0.0585 - 0.0587 in.)
		Mark 2	1.490 - 1.494 mm (0.0587 - 0.0588 in.)
		Mark 3	1.494 - 1.498 mm (0.0588 - 0.0590 in.)
	Connecting rod oil clearance	STD	0.028 - 0.060 mm (0.0011 - 0.0024 in.)
		Maximum	0.08 mm (0.0031 in.)
	Rod out-of-alignment	Maximum per/100 mm (3.94 in.)	0.05 mm (0.0020 in.)
	Rod twist	Maximum per/100 mm (3.94 in.)	0.05 mm (0.0020 in.)
	Bushing inside diameter		20.012 - 20.021 mm (0.7879 - 0.7882 in.)
	Piston pin diameter		20.004 - 20.013 mm (0.7876 - 0.7879 in.)
	Bushing oil clearance	STD	0.005 - 0.011 mm (0.0002 - 0.0004 in.)
		Maximum	0.05 mm (0.0020 in.)
	Connecting rod bolt diameter		
		at tension portion STD	6.6 - 6.7 mm (0.260 - 0.264 in.)
		Minimum	6.4 mm (0.252 in.)
	2ZZ-GE:		
	Thrust clearance	STD	0.160 - 0.342 mm (0.0063 - 0.0135 in.)
		Maximum	0.342 mm (0.0135 in.)
	Connecting rod thickness		19.788 - 19.840 mm (0.7791 - 0.7811 in.)
	Connecting rod bearing center wall thickness		
	Reference	Mark 1	1.482 - 1.486 mm (0.0583 - 0.0585 in.)
		Mark 2	1.486 - 1.490 mm (0.0585 - 0.0587 in.)
		Mark 3	1.490 - 1.494 mm (0.0587 - 0.0588 in.)
	Connecting rod oil clearance	STD	0.028 - 0.052 mm (0.0011 - 0.0020 in.)
	Maximum	0.08 mm (0.0031 in.)	
Rod out-of-alignment	Maximum per/100 mm (3.94 in.)	0.05 mm (0.0020 in.)	
Rod twist	Maximum per/100 mm (3.94 in.)	0.05 mm (0.0020 in.)	
Bushing inside diameter	Connecting rod	20.011 - 20.023 mm (0.7878 - 0.7883 in.)	
	Piston	20.013 - 20.025 mm (0.7879 - 0.7884 in.)	
Piston pin diameter		20.004 - 20.016 mm (0.7876 - 0.7880 in.)	
Bushing oil clearance	STD Piston x Piston pin	0.005 - 0.013 mm (0.0002 - 0.0005 in.)	
	Piston pin x Connecting rod	0.005 - 0.009 mm (0.0002 - 0.0004 in.)	
	Maximum	0.05 mm (0.0020 in.)	
Connecting rod bolt diameter			
	at tension portion STD	6.6 - 6.7 mm (0.260 - 0.264 in.)	
	Minimum	6.4 mm (0.252 in.)	

Crankshaft	1ZZ-FE:		
	Thrust clearance	STD	0.04 - 0.24 mm (0.0016 - 0.0094 in.)
		Maximum	0.30 mm (0.0118 in.)
	Thrust washer thickness		2.430 - 2.480 mm (0.0957 - 0.0976 in.)
	Main journal oil clearance	STD	0.015 - 0.032 mm (0.0006 - 0.0013 in.)
		Maximum	0.050 mm (0.0020 in.)
	Main journal diameter	Mark 0	47.998 - 48.000 mm (1.8897 - 1.8898 in.)
		Mark 1	47.996 - 47.998 mm (1.8896 - 1.8897 in.)
		Mark 2	47.994 - 47.996 mm (1.8895 - 1.8896 in.)
		Mark 3	47.992 - 47.994 mm (1.8894 - 1.8895 in.)
		Mark 4	47.990 - 47.992 mm (1.8893 - 1.8894 in.)
		Mark 5	47.988 - 47.990 mm (1.8892 - 1.8893 in.)
	Main bearing center wall thickness		
	Reference	Mark 1	1.993 - 1.996 mm (0.0785 - 0.0786 in.)
		Mark 2	1.996 - 1.999 mm (0.0786 - 0.0787 in.)
		Mark 3	1.999 - 2.002 mm (0.0787 - 0.0788 in.)
		Mark 4	2.002 - 2.005 mm (0.0788 - 0.0789 in.)
	Crank pin diameter		43.992 - 44.000 mm (1.7320 - 1.7323 in.)
	Circle runout	Maximum	0.03 mm (0.0012 in.)
	Main journal taper and out-of round	Maximum	0.02 mm (0.0008 in.)
	Crank pin taper and out-of round	Maximum	0.02 mm (0.0008 in.)
	2ZZ-GE:		
	Thrust clearance	STD	0.04 - 0.24 mm (0.0016 - 0.0094 in.)
		Maximum	0.30 mm (0.0118 in.)
	Thrust washer thickness		2.430 - 2.480 mm (0.0957 - 0.0976 in.)
	Main journal oil clearance	STD	0.016 - 0.032 mm (0.0006 - 0.0013 in.)
		Maximum	0.050 mm (0.0020 in.)
	Main journal diameter	Mark 0	47.998 - 48.000 mm (1.8897 - 1.8898 in.)
		Mark 1	47.996 - 47.998 mm (1.8896 - 1.8897 in.)
		Mark 2	47.994 - 47.996 mm (1.8895 - 1.8896 in.)
	Mark 3	47.992 - 47.994 mm (1.8894 - 1.8895 in.)	
	Mark 4	47.990 - 47.992 mm (1.8893 - 1.8894 in.)	
	Mark 5	47.988 - 47.990 mm (1.8892 - 1.8893 in.)	
Main bearing center wall thickness			
Reference	Mark 1	1.989 - 1.992 mm (0.0783 - 0.0784 in.)	
	Mark 2	1.992 - 1.995 mm (0.0784 - 0.0785 in.)	
	Mark 3	1.995 - 1.998 mm (0.0785 - 0.0787 in.)	
	Mark 4	1.998 - 2.001 mm (0.0787 - 0.0788 in.)	
	Mark 5	2.001 - 2.004 mm (0.0788 - 0.0789 in.)	
Crank pin diameter		44.992 - 45.000 mm (1.7713 - 1.7717 in.)	
Circle runout	Maximum	0.03 mm (0.0012 in.)	
Main journal taper and out-of round	Maximum	0.02 mm (0.0008 in.)	
Crank pin taper and out-of round	Maximum	0.02 mm (0.0008 in.)	

TORQUE SPECIFICATION

SS9A3-01

Part tightened		N·m	kgf·cm	ft·lbf	
Camshaft timing sprocket x Camshaft	1ZZ-FE	45	460	33	
	2ZZ-GE	54	551	40	
Valve timing controller assembly x Camshaft	1ZZ-FE	45	460	33	
	2ZZ-GE	54	551	40	
Chain vibration damper x Cylinder block	1ZZ-FE	11	113	8	
	2ZZ-GE	20.5	209	15	
Chain tensioner slipper x Cylinder block	1ZZ-FE	18.5	189	14	
	2ZZ-GE	20.5	209	15	
Timing chain cover 1ZZ-FE: (See page EM-25)	10 mm head bolt A	13	133	10	
	10 mm head bolt C	9	92	80 in.·lbf	
	10 mm head bolt others	11	113	8	
	12 mm head bolt D	18.5	189	14	
	Stud (E8)	9.3	95	82 in.·lbf	
	2ZZ-GE: (See page EM-25)	Bolt A	21	214	15
		Bolt B	11	113	8
		Bolt C	9.0	92	80 in.·lbf
		Bolt D	9.0	92	80 in.·lbf
Stud (E8)		9.3	95	82 in.·lbf	
RH engine mounting bracket x Timing chain cover	1ZZ-FE	47	479	35	
	2ZZ-GE	49	500	36	
Driver belt tensioner x Timing chain cover	Bolt				
	1ZZ-FE	69	704	51	
	2ZZ-GE	100	1,020	74	
	Nut	29	296	21	
Crankshaft position sensor x Timing chain cover		9.0	92	80 in.·lbf	
Crankshaft pulley x Crankshaft	1ZZ-FE	138	1,409	102	
	2ZZ-GE	120	1,200	87	
Chain tensioner x Timing chain cover		9.0	92	80 in.·lbf	
Cylinder head cover x Cylinder head	1ZZ-FE w/ Washer	9.0	92	80 in.·lbf	
	w/o Washer	11	113	8	
	2ZZ-GE	10	100	7	
No. 1 ventilation pipe x Cylinder head cover		10	100	7	
No. 1 ventilation pipe x Intake manifold	2ZZ-GE	25	255	18	
RH engine mounting insulator		52	530	38	
PS pump x Engine		36	370	27	
Camshaft bearing cap x Cylinder head	1ZZ-FE No. 1	23	235	17	
	No. 3	13	133	10	
	2ZZ-GE	18.5	189	14	
Rocker No. 1 and No. 2 shaft x Cylinder head	2ZZ-GE	7.5	76	66 in.·lbf	
Oil control valve housing x Cylinder head	2ZZ-GE	9.0	92	80	
Oil pressure switch x Cylinder head	2ZZ-GE	13	130	9	
Oil control valve filter x Cylinder head	2ZZ-GE	29	300	22	
Cylinder head x Cylinder block	1ZZ-FE 1st	49	500	36	
	2nd	Turn 90°	Turn 90°	Turn 90°	
	2ZZ-GE 1st	35	375	26	
	2nd	Turn 180°	Turn 180°	Turn 180°	
Water bypass pipe x Cylinder head		9.0	92	80 in.·lbf	

Intake manifold x Cylinder head		18.5	189	14
1ZZ-FE:				
2ZZ-GE: (See page EM-65)	Bolt A	27	275	20
	Bolt B	46	469	34
	Bolt others	34	347	25
Intake manifold stay	2ZZ-GE	24	245	18
Exhaust manifold x Cylinder head	1ZZ-FE	37	377	27
	2ZZ-GE	50	510	37
Lower heat insulator x Exhaust manifold	1ZZ-FE	12	123	9
	2ZZ-GE	20	204	15
Upper heat insulator x Exhaust manifold	1ZZ-FE	12	123	9
	2ZZ-GE	20	204	15
Exhaust manifold stay	1ZZ-FE	49	500	37
	2ZZ-GE	50	510	37
Engine hanger x Cylinder head		38	388	28
LH engine mounting		80	816	59
Rear engine mounting bracket x Transaxle		64	653	47
Rear engine mounting	Through bolt	87	887	64
Suspension member	Bolt A	52	530	32
(See page EM-80)	Bolt B	52	530	32
	Bolt C	113	1,152	83
	Bolt D	157	1,600	116
	Bolt E	39	400	29
	Nut	52	530	32
PS gear x Suspension member		45	460	33
Exhaust pipe		43	440	32
Clutch release cylinder x Transaxle		12	120	9
Clutch release cylinder bracket	Bolt A	12	120	9
	Bolt B	4.9	50	43 in. lbf
A/C Compressor x Engine		25	255	18
ECM box stay	Nut	12	120	9
	Bolt	18	185	13
ECM box		6.9	70	61 in. lbf
ECM cover		6.9	70	61 in. lbf
Air cleaner case		5.0	51	44 in. lbf
Bearing cap sub-assembly x Cylinder block	12 pointed head 1st	22	225	16
	2nd	44	449	32
	3rd	Turn 45°	Turn 45°	Turn 45°
	4th	Turn 45°	Turn 45°	Turn 45°
	Hexagon head 1ZZ-FE	18.5	189	14
	2ZZ-GE	18	185	13
Screw plug x Bearing cap sub-assembly	2ZZ-GE	43	438	32
Connecting rod cap	1ZZ-FE 1st	20	204	15
	2nd	Turn 90°	Turn 90°	Turn 90°
	2ZZ-GE 1st	30	306	22
	2nd	Turn 90°	Turn 90°	Turn 90°
Oil strainer		9.0	92	80 in. lbf
Oil pan baffle	2ZZ-GE	9.0	92	80 in. lbf
Oil pan		9.0	92	80 in. lbf
Oil filter union		30	306	21

SERVICE SPECIFICATIONS - ENGINE MECHANICAL

Engine coolant drain union	1ZZ-FE	20	200	14
	2ZZ-GE	25	255	18
Knock sensor		39	400	29
Ventilation case	2ZZ-GE	8.5	87	75 in.-lbf
Water bypass pipe x Cylinder block	1ZZ-FE	9.0	92	80 in.-lbf
	2ZZ-GE			
	Bolt	8.5	87	75 in.-lbf
	Nut	10	100	7
Dipstick guide	1ZZ-FE	11	113	8
	2ZZ-GE	25	255	18
Fly wheel	1st	49	500	36
	2nd	Turn 90°	Turn 90°	Turn 90°
Drive plate		88	897	65

EMISSION CONTROL TORQUE SPECIFICATION

SE04K-02

Part tightened	N·m	kgf·cm	ft·lbf
Charcoal canister x Body	18	184	13

SFI

SERVICE DATA

SS004-02

Fuel pressure regulator	Fuel pressure	301 - 347 kPa (3.1 - 3.5 kgf/cm ² , 44 - 50 psi)
Fuel pump	Resistance at 20°C (68°F)	0.2 - 3.0 Ω
Injector	Resistance at 20°C (68°F)	13.4 - 14.2 Ω
	Injection volume	47 - 58 cm ³ (2.7 - 3.3 cu in.) per 15 seconds
	Difference between each cylinder	10 cm ³ (0.6 cu in.) or less
	Fuel leakage	One drop or less per 12 minutes
Mass air flow meter	Resistance at -20°C (-4°F)	13.6 - 18.4 kΩ
	Resistance at 20°C (68°F)	2.21 - 2.69 kΩ
	Resistance at 60°C (140°F)	0.49 - 0.67 kΩ
Throttle position sensor	Clearance between stop screw and lever 0 mm (0 in.)	VTA - E2 0.2 - 5.7 kΩ
	Throttle valve fully open	VTA - E2 2.0 - 10.2 kΩ
	-	VC - E2 2.5 - 5.9 kΩ
Camshaft timing oil control valve	Resistance at 20°C (68°F)	6.9 - 7.9 Ω
VSV (CCV)	Resistance at 20°C (68°F)	24 - 30 Ω
VSV (Pressure switching valve)	Resistance at 20°C (68°F)	37 - 44 Ω
	Resistance at 120°C (248°F)	51 ± 62 Ω
VSV (EVAP)	Resistance at 20°C (68°F)	27 - 33 Ω
VSV (Intake air control valve)	Resistance at 20°C (68°F)	37 - 44 Ω
ECT sensor	Resistance at -20°C (-4°F)	10 - 20 kΩ
	Resistance at 0°C (32°F)	4 - 7 kΩ
	Resistance at 20°C (68°F)	2 - 3 kΩ
	Resistance at 40°C (104°F)	0.9 - 1.3 kΩ
	Resistance at 60°C (140°F)	0.4 - 0.7 kΩ
	Resistance at 80°C (176°F)	0.2 - 0.4 kΩ
Vapor pressure sensor	Power source voltage	4.5 - 5.5 V
	Remove fuel tank cap Terminal 2 - 3	3.0 - 3.6 V
Heated oxygen sensor	Heater coil resistance	11 - 16 Ω
Fuel cut rpm	Fuel return rpm	1,500 rpm

TORQUE SPECIFICATION

Part tightened		N·m	kgf·cm	ft·lbf
Delivery pipe x Cylinder head	1ZZ-FE	19	190	14
	2ZZ-GE	29	290	21
Fuel pump x Fuel tank		4.0	40	35 in.·lbf
Fuel tank band x Body		39	400	29
Throttle body x Intake manifold	1ZZ-FE	21	210	15
	2ZZ-GE	22	220	16
Camshaft timing oil control valve x Cylinder head	1ZZ-FE	7.5	80	66 in.·lbf
	2ZZ-GE	8.5	87	75 in.·lbf
Knock sensor 1 x Cylinder block		44	450	33
Oxygen sensor x Front exhaust pipe		44	450	33

COOLING

SERVICE DATA

SS040-C2

Thermostat	Valve opening temperature Valve lift at 90°C (194°F)	80.0 - 84.0°C (176 - 183°F) 10 mm (0.39 in.)
Radiator cap	Relief valve opening pressure STD Minimum	93 - 123 kPa (0.95 - 1.25 kgf/cm ² , 13.5 - 17.8 psi) 79 kPa (0.8 kgf/cm ² , 11.5 psi)
Electric cooling fan	Rotating amperage	5.2 - 8.2 A

TORQUE SPECIFICATION

Part tightened	N·m	kgf·cm	ft·lbf
Drain plug x Radiator	12.7	130	9
Water pump x Timing chain cover (See page CO-7)	1ZZ-FE		
	Bolt A	9.0	92
	Bolt B	11	113
	2ZZ-GE	9.0	92
Water pump pulley x Water pump	15	153	11
Water inlet x Cylinder block	10	100	7
Electric cooling fan x Radiator	6.0	60	53 in·lbf
Engine coolant reservoir x Radiator upper support	5.0	51	44 in·lbf
Fan motor x Fan shroud	2.55	26	23 in·lbf
Fan x Fan motor	6.18	63	55 in·lbf

LUBRICATION SERVICE DATA

SS04A2-02

Oil pressure	Oil control valve housing	1ZZ-FE	
		at idle speed	29 kPa (0.3 kgf/cm ² , 43 psi) or more
		at 3,000 rpm	294 - 539 kPa (3.0 - 5.5 kgf/cm ² , 43 - 78 psi)
		2ZZ-GE	
Oil pump	Side clearance	at idle speed	39.2 kPa (0.4 kgf/cm ² , 5.7 psi) or more
		2ZZ-GE	
		at idle speed	39.2 kPa (0.4 kgf/cm ² , 5.7 psi) or more
		Maximum	0.025 - 0.075 mm (0.0010 - 0.0030 in.)
Oil pump	Tip clearance	STD	0.060 - 0.180 mm (0.0024 - 0.0071 in.)
		Maximum	0.15 mm (0.0059 in.)
		STD	0.060 - 0.180 mm (0.0024 - 0.0071 in.)
		Maximum	0.35 mm (0.0138 in.)
Oil pump	Body clearance	STD	0.100 - 0.180 mm (0.0039 - 0.0071 in.)
		Maximum	0.30 mm (0.0118 in.)
		STD	0.100 - 0.180 mm (0.0039 - 0.0071 in.)
		Maximum	0.30 mm (0.0118 in.)

TORQUE SPECIFICATION

Part tightened	N·m	kgf·cm	ft·lbf
Oil pressure switch x Cylinder block	13	130	9
Oil pressure switch x Oil control valve housing	13	130	9
Drain plug x Oil pan	37	378	27
Oil pump body cover x Oil pump body	10.5	107	8
Plug x Oil pump	1ZZ-FE	37	27
	2ZZ-GE	49	36
Oil pump x Cylinder block	9.0	92	80 in·lbf
Oil nozzle x Cylinder block	9.0	92	80 in·lbf

IGNITION

SERVICE DATA

SS-23-04

Spark plug	Recommended spark plug	1ZZ-FE DENSO NGK 2ZZ-GE DENSO NGK	SK16R11 IFR5A11 SK20R11 IFR6A11
Camshaft position sensor	Resistance	at cold at hot	835 - 1,400 Ω 1,060 - 1,645 Ω
Crankshaft position sensor	Resistance	at cold at hot	1,630 - 2,740 Ω 2,065 - 3,225 Ω

TORQUE SPECIFICATION

Part tightened	N·m	kgf·cm	ft·lbf
Spark plug x Cylinder head	18	184	13
Ignition coil (w/ Igniter) x Cylinder head cover	7.5	77	66 in.·lbf
Camshaft position sensor x Cylinder head	8.8	90	78 in.·lbf
Crankshaft position sensor x Timing chain cover	8.8	90	78 in.·lbf

STARTING

SERVICE DATA

ESOMJ-02

Starter	Rated voltage and output power		12 V 1.4 kW 12 V 1.2kW
	No-load characteristics	Current	90 A or less at 11.5 V
		rpm	3,000 rpm or more
	Brush length	STD	15.5 mm (0.610 in.)
		Minimum	10.0 mm (0.394 in.)
	Spring installed load	STD	
		1.4 kW	17.6 - 23.5 N (1.8 - 2.4 kgf, 4.0 - 5.3 lbf)
		1.2 kW	13.7 - 19.6 N (1.4 - 2.0 kgf, 3.1 - 4.6 lbf)
		Minimum	
		1.4 kW	11.8 N (1.2 kgf, 2.6 lbf)
		1.2 kW	8.8 N (0.9 kgf, 2.0 lbf)
	Commutator		
	Diameter	STD	30.0 mm (1.181 in.)
		Minimum	29.0 mm (1.412 in.)
Undercut depth	STD	0.6 mm (0.024 in.)	
	Minimum	0.2 mm (0.008 in.)	
Circle runout	Maximum	0.05 mm (0.0020 in.)	
Magnetic switch			
Contact plate for wear	Maximum	0.9 mm (0.035 in.)	

TORQUE SPECIFICATION

Part tightened	N·m	kgf·cm	ft·lbf
Starter x Transaxle	37	380	28
End cover x Brush holder	3.8	39	34 in·lbf
Starter housing x Magnetic switch	9.3	95	82 in·lbf
End cover x Starter housing	9.3	95	82 in·lbf
Lead wire x Terminal C of starter	5.9	60	52 in·lbf
Terminal nut x Terminal C of starter, Terminal 30 of starter	17	173	12
Magnetic switch end cover x Magnetic switch	2.5	26	23 in·lbf

CHARGING

SERVICE DATA

SS0M1-02

Battery	Voltage	at 20°C (68°F)	12.7 - 12.9 V
	Specific gravity	at 20°C (68°F)	1.25 - 1.29
Generator	Rated output		12 V 80 A
	Rotor coil resistance	M/T	2.7 - 3.1 Ω
		A/T	2.1 - 2.5 Ω
	Slip ring diameter	STD	14.2 - 14.4 mm (0.559 - 0.567 in.)
		Minimum	12.8 mm (0.504 in.)
Brush exposed length	STD	10.5 mm (0.413 in.)	
	Minimum	1.5 mm (0.059 in.)	
Voltage regulator	Regulating voltage		13.2 - 14.8 V

TORQUE SPECIFICATION

Part tightened	N·m	kgf·cm	ft·lbf
Bearing retainer x Drive end frame	3.0	31	27 in.·lbf
Rectifier end frame x Drive end frame	Nut A	4.5	40 in.·lbf
	Nut B	5.4	48 in.·lbf
Generator pulley x Rotor	111	1,125	81
Rectifier end frame x Brush holder, Voltage regulator	2.0	20	17 in.·lbf
Rectifier holder x Coil lead on rectifier end frame	2.9	30	25 in.·lbf
Rear end cover x Rectifier holder	4.4	45	39 in.·lbf
Plate terminal x Rectifier holder	Nut	4.4	39 in.·lbf
	Bot	3.9	35 in.·lbf
Terminal insulator x Rectifier holder	4.1	42	36 in.·lbf
Generator x RH engine mount bracket	25	20	18
Generator x Cylinder block	1ZZ-FE	54	40
	2ZZ-GE	58	43
Generator x Generator bracket	29	295	21

CLUTCH

SERVICE DATA

SS09-03

Pedal height from asphalt sheet	Standard pedal	135.6 – 145.6 mm (5.339 – 5.732 in.)
	Sport pedal	136.9 – 146.9 mm (5.390 – 5.783 in.)
Pedal freeplay		1.0 – 5.0 mm (0.039 – 0.197 in.)
Push rod play at pedal top		5.0 – 15.0 mm (0.197 – 0.591 in.)
Clutch release point from pedal full stroke end position		25 mm (0.98 in.) or more
Slotted spring pin protrusion		1.5 – 2.5 mm (0.059 – 0.098 in.)
Disc rivet head depth	Min.	0.3 mm (0.012 in.)
Disc runout	Max.	0.8 mm (0.031 in.)
Flywheel runout	Max.	0.1 mm (0.004 in.)
Diaphragm spring finger wear	Max. depth	0.5 mm (0.020 in.)
Diaphragm spring finger wear	Max. width	6.0 mm (0.236 in.)
Diaphragm spring tip non-alignment	Max.	0.5 mm (0.020 in.)

TORQUE SPECIFICATION

Part tightened	N·m	kgf·cm	ft·lbf
Clutch line union	15	155	11
Master cylinder installation nut	12	120	9
Bleeder plug	8.4	85	74 in.·lbf
Release cylinder installation bolt	12	120	9
Clutch line clamp x Clutch line bracket	4.9	50	43 in.·lbf
Flywheel set bolt	49	500	36
Clutch cover x Flywheel	19	195	14
Release fork support	37	375	27

MANUAL TRANSAXLE (C56)

SERVICE DATA

SS02P-03

Input shaft roller bearing journal diameter	Min.	24.985 mm (0.9837 in.)
Input shaft 3rd gear journal diameter	Min.	30.985 mm (1.2199 in.)
Input shaft 4th gear journal diameter	Min.	28.985 mm (1.1411 in.)
Input shaft 5th gear journal diameter	Min.	24.885 mm (0.9797 in.)
Input shaft runout	Max.	0.03 mm (0.0012 in.)
Output shaft roller bearing journal diameter	Min.	32.985 mm (1.2986 in.)
Output shaft 1st gear journal diameter	Min.	37.985 mm (1.4955 in.)
Output shaft 2nd gear journal diameter	Min.	31.985 mm (1.2592 in.)
Output shaft runout	Max.	0.03 mm (0.0012 in.)
Gear thrust clearance 1st	STD	0.10 – 0.40 mm (0.0039 – 0.0157 in.)
	Max.	0.40 mm (0.0157 in.)
Gear thrust clearance 2nd	STD	0.10 – 0.55 mm (0.0039 – 0.0217 in.)
	Max.	0.55 mm (0.0217 in.)
Gear thrust clearance 3rd	STD	0.10 – 0.35 mm (0.0039 – 0.0138 in.)
	Max.	0.35 mm (0.0138 in.)
Gear thrust clearance 4th	STD	0.10 – 0.55 mm (0.0039 – 0.0217 in.)
	Max.	0.55 mm (0.0217 in.)
Gear thrust clearance 5th	STD	0.10 – 0.57 mm (0.0039 – 0.0224 in.)
	Max.	0.57 mm (0.0224 in.)
Gear radial clearance 1st, 2nd, 3rd, 4th and 5th (KOYO made)	STD	0.015 – 0.058 mm (0.0006 – 0.0023 in.)
	Max.	0.058 mm (0.0023 in.)
Gear radial clearance 1st, 2nd, 3rd, 4th and 5th (NSK made)	STD	0.015 – 0.056 mm (0.0006 – 0.0022 in.)
	Max.	0.056 mm (0.0022 in.)
No. 3 gear shift fork to No. 3 hub sleeve clearance	Max.	0.5 mm (0.020 in.)
No. 2 gear shift fork to No. 2 hub sleeve clearance	Max.	0.35 mm (0.014 in.)
No. 1 gear shift fork to reverse gear clearance	Max.	0.35 mm (0.014 in.)
Synchronizer ring to gear clearance 1st, 4th and 5th	Min.	0.75 mm (0.0295 in.)
Synchronizer ring to gear clearance 3rd	Min.	0.65 mm (0.0256 in.)
Synchronizer ring to gear clearance 2nd	Min.	0.70 mm (0.0276 in.)
Drive in depth		
Input shaft front oil seal		15.8 ± 0.2 mm (0.622 ± 0.008 in.)
Input shaft front bearing		0 – 0.3 mm (0 – 0.012 in.)
Transmission case bushing		0.80 – 1.30 mm (0.0315 – 0.0512 in.)
Transmission case oil seal (Shift and select lever shaft side)		10.0 ± 0.3 mm (0.394 ± 0.012 in.)
Transmission case oil seal (Differential case side)		9.9 ± 0.3 mm (0.390 ± 0.012 in.)
Transaxle case oil seal		1.9 ± 0.3 mm (0.075 ± 0.012 in.)
Select inner lever slotted spring pin		0 ± 0.5 mm (0 ± 0.020 in.)
No. 1 shift inner lever slotted spring pin		0 ± 0.5 mm (0 ± 0.020 in.)
No. 2 shift inner lever slotted spring pin		3.5 ± 0.5 mm (0.138 ± 0.020 in.)

<p>Input shaft snap ring thickness No. 2 clutch hub</p> <p>Rear radial ball bearing</p>	<p>Mark 0 2.30 mm (0.0906 in.) Mark 1 2.36 mm (0.0929 in.) Mark 2 2.42 mm (0.0953 in.) Mark 3 2.48 mm (0.0976 in.) Mark 4 2.54 mm (0.1000 in.) Mark 5 2.60 mm (0.1024 in.) Mark A 2.29 mm (0.0902 in.) Mark B 2.35 mm (0.0925 in.) Mark C 2.41 mm (0.0949 in.) Mark D 2.47 mm (0.0972 in.) Mark E 2.53 mm (0.0996 in.) Mark F 2.59 mm (0.1020 in.)</p>
<p>Output shaft snap ring thickness No. 1 clutch hub</p> <p>Front bearing inner race</p> <p>No. 3 clutch hub</p>	<p>Mark A 2.50 mm (0.0984 in.) Mark B 2.56 mm (0.1008 in.) Mark C 2.62 mm (0.1031 in.) Mark D 2.68 mm (0.1055 in.) Mark E 2.74 mm (0.1079 in.) Mark F 2.80 mm (0.1102 in.) Mark 7 1.85 mm (0.0728 in.) Mark 8 1.90 mm (0.0748 in.) Mark 1 1.95 mm (0.0768 in.) Mark 2 2.00 mm (0.0787 in.) Mark 3 2.05 mm (0.0807 in.) Mark 4 2.10 mm (0.0827 in.) Mark 5 2.15 mm (0.0846 in.) Mark 6 2.20 mm (0.0866 in.) Mark A 2.25 mm (0.0886 in.) Mark B 2.31 mm (0.0909 in.) Mark C 2.37 mm (0.0933 in.) Mark D 2.43 mm (0.0957 in.) Mark E 2.49 mm (0.0980 in.) Mark F 2.55 mm (0.1004 in.) Mark G 2.61 mm (0.1028 in.)</p>
<p>Differential tapered roller bearing preload (at starting)(For use with SST) New bearing Reused bearing</p>	<p>0.8 - 1.6 N·m (8 - 16 kgf·cm, 6.9 - 13.9 in.·lbf) 0.5 - 1.0 N·m (5 - 10 kgf·cm, 4.3 - 8.7 in.·lbf)</p>
<p>Differential pinion to side gear backlash</p>	<p>0.05 mm - 0.20 mm (0.0020 - 0.0079 in.)</p>
<p>Differential side gear thrust washer thickness</p>	<p>0.95 mm (0.0374 in.) 1.00 mm (0.0394 in.) 1.05 mm (0.0413 in.) 1.10 mm (0.0433 in.) 1.15 mm (0.0453 in.) 1.20 mm (0.0472 in.)</p>

Differential tapered roller bearing adjusting shim thickness

Mark AA	2.10 mm (0.0827 in.)
Mark BB	2.15 mm (0.0846 in.)
Mark CC	2.20 mm (0.0866 in.)
Mark DD	2.25 mm (0.0886 in.)
Mark EE	2.30 mm (0.0906 in.)
Mark FF	2.35 mm (0.0925 in.)
Mark GG	2.40 mm (0.0945 in.)
Mark HH	2.45 mm (0.0965 in.)
Mark JJ	2.50 mm (0.0984 in.)
Mark KK	2.55 mm (0.1004 in.)
Mark LL	2.60 mm (0.1024 in.)
Mark MM	2.65 mm (0.1043 in.)
Mark NN	2.70 mm (0.1063 in.)
Mark PP	2.75 mm (0.1083 in.)
Mark QQ	2.80 mm (0.1102 in.)
Mark RR	2.85 mm (0.1122 in.)
Mark SS	2.90 mm (0.1142 in.)
Mark TT	2.95 mm (0.1161 in.)
Mark UU	3.00 mm (0.1181 in.)

TORQUE SPECIFICATION

Part tightened		N·m	kgf·cm	ft·lbf
No. 2 cylinder head cover		7.0	71	62 in.·lbf
Radiator reservoir set bolt		4.9	50	43 in.·lbf
ECM cover x ECM box		6.9	70	61 in.·lbf
ECM box set bolt		6.9	70	61 in.·lbf
Battery carrier x Body	Bolt	18	185	13
	Nut	12	120	9
Clutch line set bolt (See page MX-4)	Bolt A	12	120	9
	Bolt B	4.9	50	43 in.·lbf
Clutch release cylinder x Transaxle		12	120	9
Starter x Transaxle		37	378	28
Transaxle x Engine (From transaxle side)		64	650	47
Transaxle x Engine (From engine side) (See page MX-4)	Bolt A	47	480	35
	Bolt B	23	230	17
No. 1 and No. 2 engine hangers set bolt		38	387	28
Engine left mounting bracket x Transaxle		60	610	44
Engine left mounting bracket x Engine left mounting insulator		80	820	59
Oxygen sensor x Front exhaust pipe		44	450	33
Front exhaust pipe		43	440	32
PS gear assembly x Suspension crossmember		45	459	33
Engine rear mounting insulator x Engine rear mounting bracket		87	890	64
Engine rear mounting bracket x Transaxle		64	650	47
Passenger airbag assembly		20	204	15
Airbag sensor assembly x Body		20	205	15
Steering wheel lock nut		34	350	25
Shift lever assembly x Body		12	120	9
Shift cable retainer x Body		4.9	50	43 in.·lbf
Shift and select control cable bracket		4.9	50	43 in.·lbf
Filter and drain plugs		39	400	29
Vehicle speed sensor		11	115	8
Back-up light switch		40	410	30
Control cable bracket x Transaxle case		25	250	18
Control shaft assembly		12	120	9
Selecting bellcrank assembly x Transmission case		25	250	18
Lever lock pin set nut		12	120	9
Transmission case x Transmission case cover		18	185	13
Lock ball assembly (Shift and select lever shaft side)		29	300	22
Control shaft cover x Transmission case		20	200	14
5th driven gear lock nut		118	1,200	87
No. 1, No. 2 and No. 3 gear shift forks set bolt		16	160	12
Rear bearing retainer x Transmission case		27	280	20
Reverse idler gear shaft lock bolt		29	300	22
Straight screw plug		25	250	18
Lock ball assembly (Reverse shift fork side)		39	400	29
Transmission case x Transaxle case		29	300	22

SERVICE SPECIFICATIONS - MANUAL TRANSAXLE (C56)

Oil receiver pipe set bolt	17	175	13
Reverse shift arm bracket x Transaxle case	17	175	13
No. 1 gear shift head set bolt	16	160	12
Output shaft front bearing lock plate set bolt	11	115	8
Transaxle case receiver x Transaxle case	11	115	8
Straight screw plug (Reverse restrict pin)	13	130	9
Differential case x Ring gear	77	790	57

MANUAL TRANSAXLE (C60)

SS042-02

SERVICE DATA

Input shaft roller bearing journal diameter	Min.	24.985 mm (0.9837 in.)
Input shaft 3rd gear journal diameter	Min.	30.985 mm (1.2199 in.)
Input shaft 4th gear journal diameter	Min.	28.985 mm (1.1411 in.)
Input shaft 5th gear journal diameter	Min.	24.885 mm (0.9797 in.)
Input shaft 6th gear journal diameter	Min.	21.991 mm (0.8658 in.)
Input shaft runout	Max.	0.03 mm (0.0012 in.)
Output shaft roller bearing journal diameter	Min.	32.985 mm (1.2986 in.)
Output shaft 1st gear journal diameter	Min.	37.985 mm (1.4955 in.)
Output shaft 2nd gear journal diameter	Min.	31.985 mm (1.2592 in.)
Output shaft runout	Max.	0.03 mm (0.0012 in.)
Gear thrust clearance 1st	STD	0.10 – 0.40 mm (0.0039 – 0.0157 in.)
	Max.	0.40 mm (0.0157 in.)
Gear thrust clearance 2nd	STD	0.10 – 0.55 mm (0.0039 – 0.0217 in.)
	Max.	0.55 mm (0.0217 in.)
Gear thrust clearance 3rd	STD	0.10 – 0.35 mm (0.0039 – 0.0138 in.)
	Max.	0.35 mm (0.0138 in.)
Gear thrust clearance 4th	STD	0.10 – 0.55 mm (0.0039 – 0.0217 in.)
	Max.	0.55 mm (0.0217 in.)
Gear thrust clearance 5th	STD	0.10 – 0.62 mm (0.0039 – 0.0244 in.)
	Max.	0.62 mm (0.0244 in.)
Gear thrust clearance 6th	STD	0.10 – 0.60 mm (0.0039 – 0.0236 in.)
	Max.	0.60 mm (0.0236 in.)
Gear radial clearance 1st, 2nd, 3rd and 4th (KOYO made)	STD	0.15 – 0.58 mm (0.0006 – 0.0023 in.)
	Max.	0.058 mm (0.0023 in.)
Gear radial clearance 1st, 2nd, 3rd and 4th (NSK made)	STD	0.015 – 0.056 mm (0.0006 – 0.0022 in.)
	Max.	0.056 mm (0.0022 in.)
Gear radial clearance 5th	STD	0.015 – 0.056 mm (0.0006 – 0.0022 in.)
	Max.	0.056 mm (0.0022 in.)
Gear radial clearance 6th	STD	0.009 – 0.050 mm (0.0003 – 0.0020 in.)
	Max.	0.050 mm (0.0020 in.)
No. 3 gear shift fork to No. 3 hub sleeve clearance	Max.	0.89 mm (0.035 in.)
No. 2 gear shift fork to No. 2 hub sleeve clearance	Max.	0.35 mm (0.014 in.)
No. 1 gear shift fork to reverse gear clearance	Max.	0.35 mm (0.014 in.)
Synchronizer ring to gear clearance 1st, 4th, 5th and 6th	Min.	0.75 mm (0.0295 in.)
Synchronizer ring to gear clearance 3rd	Min.	0.65 mm (0.0256 in.)
Synchronizer ring to gear clearance 2nd	Min.	0.70 mm (0.0276 in.)
Drive in depth		
Input shaft front oil seal		15.8 ± 0.2 mm (0.622 ± 0.008 in.)
Input shaft front bearing		0 – 0.3 mm (0 – 0.012 in.)
Transmission case bushing		0.80 – 1.30 mm (0.0315 – 0.0512 in.)
Transmission case oil seal (Shift and select lever shaft side)		10.0 ± 0.3 mm (0.394 ± 0.012 in.)
No. 1 and No. 2 shift inner lever slotted spring pin		0 ± 0.5 mm (0 ± 0.020 in.)
Transmission case oil seal (Differential case side)		9.9 ± 0.3 mm (0.390 ± 0.012 in.)
Transaxle case oil seal		1.9 ± 0.3 mm (0.075 ± 0.012 in.)
Differential side gear backlash		0.05 – 0.20 mm (0.0020 – 0.0079 in.)

Differential side gear thrust washer thickness		0.95 mm (0.0374 in.) 1.00 mm (0.0394 in.) 1.05 mm (0.0413 in.) 1.10 mm (0.0433 in.) 1.15 mm (0.0453 in.) 1.20 mm (0.0472 in.)
Differential tapered roller bearing preload (at starting) (For use with SST)		
	New bearing	0.8 – 1.6 N·m (8 – 16 kgf·cm, 6.9 – 13.9 in.-lbf)
	Reused bearing	0.5 – 1.0 N·m (5 – 10 kgf·cm, 4.3 – 8.7 in.-lbf)
Input shaft snap ring thickness		
No. 2 clutch hub	Mark 0	2.30 mm (0.0906 in.)
	Mark 1	2.36 mm (0.0929 in.)
	Mark 2	2.42 mm (0.0953 in.)
	Mark 3	2.48 mm (0.0976 in.)
	Mark 4	2.54 mm (0.1000 in.)
	Mark 5	2.60 mm (0.1024 in.)
No. 3 clutch hub	Mark A	1.75 mm (0.0689 in.)
	Mark B	1.80 mm (0.0709 in.)
	Mark C	1.85 mm (0.0728 in.)
	Mark D	1.90 mm (0.0748 in.)
	Mark E	1.95 mm (0.0768 in.)
	Mark F	2.00 mm (0.0787 in.)
	Mark G	2.05 mm (0.0807 in.)
	Mark H	2.10 mm (0.0827 in.)
	Mark J	2.15 mm (0.0846 in.)
	Mark K	2.20 mm (0.0866 in.)
Input shaft center radial ball bearing		
	Mark A	2.29 mm (0.0902 in.)
	Mark B	2.35 mm (0.0925 in.)
	Mark C	2.41 mm (0.0949 in.)
	Mark D	2.47 mm (0.0972 in.)
	Mark E	2.53 mm (0.0996 in.)
	Mark F	2.59 mm (0.1020 in.)
Input shaft rear radial ball bearing		
	Mark A	1.70 mm (0.0669 in.)
	Mark B	1.75 mm (0.0689 in.)
	Mark C	1.80 mm (0.0709 in.)
	Mark D	1.85 mm (0.0728 in.)
	Mark E	1.90 mm (0.0748 in.)
	Mark F	1.95 mm (0.0768 in.)
	Mark G	2.00 mm (0.0787 in.)
	Mark H	2.05 mm (0.0807 in.)
	Mark J	2.10 mm (0.0827 in.)
	Mark K	2.15 mm (0.0846 in.)
	Mark L	2.20 mm (0.0866 in.)
	Mark M	2.25 mm (0.0886 in.)

Output shaft snap ring thickness No. 1 clutch hub	Mark A	2.50 mm (0.0984 in.)	
	Mark B	2.56 mm (0.1008 in.)	
	Mark C	2.62 mm (0.1031 in.)	
	Mark D	2.68 mm (0.1055 in.)	
	Mark E	2.74 mm (0.1079 in.)	
	Mark F	2.80 mm (0.1102 in.)	
	Front bearing inner race	Mark 7	1.85 mm (0.0728 in.)
		Mark 8	1.90 mm (0.0748 in.)
		Mark 1	1.95 mm (0.0768 in.)
		Mark 2	2.00 mm (0.0787 in.)
		Mark 3	2.05 mm (0.0807 in.)
		Mark 4	2.10 mm (0.0827 in.)
	Output shaft rear radial ball bearing	Mark 5	2.15 mm (0.0846 in.)
		Mark 6	2.20 mm (0.0866 in.)
		Mark B	2.31 mm (0.0909 in.)
Mark C		2.37 mm (0.0933 in.)	
Mark D		2.43 mm (0.0957 in.)	
Mark E		2.49 mm (0.0980 in.)	
Mark F		2.55 mm (0.1004 in.)	
Mark G		2.61 mm (0.1028 in.)	
Mark H		2.67 mm (0.1051 in.)	
Mark J		2.73 mm (0.1075 in.)	
Mark K		2.79 mm (0.1098 in.)	
Differential tapered roller bearing adjusting shim thickness	Mark L	2.85 mm (0.1122 in.)	
	Mark M	2.91 mm (0.1146 in.)	
	Mark AA	2.10 mm (0.0827 in.)	
	Mark BB	2.15 mm (0.0846 in.)	
	Mark CC	2.20 mm (0.0866 in.)	
	Mark DD	2.25 mm (0.0886 in.)	
	Mark EE	2.30 mm (0.0906 in.)	
	Mark FF	2.35 mm (0.0925 in.)	
	Mark GG	2.40 mm (0.0945 in.)	
	Mark HH	2.45 mm (0.0965 in.)	
	Mark JJ	2.50 mm (0.0984 in.)	
	Mark KK	2.55 mm (0.1004 in.)	
	Mark LL	2.60 mm (0.1024 in.)	
	Mark MM	2.65 mm (0.1043 in.)	
Mark NN	2.70 mm (0.1063 in.)		
Mark PP	2.75 mm (0.1083 in.)		
Mark QQ	2.80 mm (0.1102 in.)		
Mark RR	2.85 mm (0.1122 in.)		
Mark SS	2.90 mm (0.1142 in.)		
Mark TT	2.95 mm (0.1161 in.)		
Mark UU	3.00 mm (0.1181 in.)		

TORQUE SPECIFICATION

SS03-02

Part tightened		N·m	kgf·cm	ft·lbf
No. 2 cylinder head cover		7.0	71	62 in.·lbf
Radiator reservoir set bolt		4.9	50	43 in.·lbf
ECM cover x ECM box		6.9	70	61 in.·lbf
ECM box set bolt		6.9	70	61 in.·lbf
Battery carrier x Body	Bolt	18	185	13
	Nut	12	120	9
Clutch line set bolt (See page MX-4)	Bolt A	12	120	9
	Bolt B	4.9	50	43 in.·lbf
Clutch release cylinder x Transaxle		12	120	9
Starter x Transaxle		37	378	28
Transaxle x Engine (From transaxle side)		64	650	47
Transaxle x Engine (From engine side) (See page MX-4)	Bolt A	47	480	35
	Bolt B	23	230	17
No. 1 and No. 2 engine hangers set bolt		38	387	28
Engine left mounting bracket x Transaxle		60	610	44
Engine left mounting bracket x Engine left mounting insulator		80	820	59
Oxygen sensor x Front exhaust pipe		44	450	33
Front exhaust pipe		43	440	32
PS gear assembly x Suspension crossmember		45	459	33
Engine rear mounting insulator x Engine rear mounting bracket		87	890	64
Engine rear mounting bracket x Transaxle		64	650	47
Passenger airbag assembly		20	204	15
Airbag sensor assembly x Body		20	205	15
Steering wheel lock nut		34	350	25
Shift lever assembly x Body		12	120	9
Shift cable retainer x Body		4.9	50	43 in.·lbf
Shift and select control cable bracket		4.9	50	43 in.·lbf
Filler and drain plug		39	400	29
Plug		39	400	29
Vehicle speed sensor		11	115	8
Back-up light switch		40	410	30
Control cable bracket x Transaxle case		25	250	18
Control shaft assembly		12	120	9
Selecting bellcrank assembly x Transmission case		25	250	18
Lever lock pin set nut		12	120	9
Transmission case cover x Transmission case		18	185	13
Lock ball assembly		29	300	22
Control shaft cover assembly x Transmission case		20	200	14
No. 1, No. 2 and No. 3 gear shift fork x Gear shift fork shaft		16	160	12
No. 1 gear shift head x Gear shift fork shaft		16	160	12
Rear bearing retainer x Transmission case		27	280	20
Reverse idler gear shaft lock bolt		29	300	22
Straight screw plug (Gear shift fork shaft)		25	250	18

Straight screw plug (See page MX-12)	Plug A	13	130	9
	Plug B	39	400	29
Transmission case x Transaxle case		29	300	22
Reverse shift arm bracket x Transaxle case		17	175	13
Output shaft front bearing lock plate set bolt		11	115	8
Transaxle case receiver x Transaxle case		11	115	8
Oil receiver pipe		17	175	13
Ring gear x Differential case		77	790	57

AUTOMATIC TRANSAXLE (U240E)**SERVICE DATA**

SSCEB-03

Line pressure (Wheel locked)	Engine idling	
	D position	372 - 412 kPa (3.8 - 4.2 kgf/cm ² , 54 - 59 psi)
	R position	672 - 742 kPa (6.9 - 7.6 kgf/cm ² , 97 - 107 psi)
	AT stall (Throttle valve fully opened)	
	D position	931 - 1,031 kPa (9.5 - 10.5 kgf/cm ² , 134 - 149 psi)
	R position	1,768 - 1,968 kPa (18.0 - 20.1 kgf/cm ² , 255 - 284 psi)
Engine stall revolution	D position	2,220 - 2,520 rpm
Time lag	N → D position	Less than 1.2 seconds
	N → R position	Less than 1.5 seconds
Engine idle speed (A/C OFF)	N position	650 ± 50 rpm
Drive plate runout	Max.	0.20 mm (0.0079 in.)
Torque converter clutch runout	Max.	0.30 mm (0.0118 in.)
Torque converter clutch installation distance		More than 12.75 mm (0.5020 in.)
Differential oil seal drive in depth	LH side	2.7 ± 0.5 mm (0.106 ± 0.020 in.)
	RH side	0 ± 0.5 mm (0 ± 0.020 in.)
Shift schedule		
D position (Throttle valve fully opened)	1 → 2	60 - 67 km/h (37 - 42 mph)
	2 → 3	112 - 123 km/h (70 - 76 mph)
	3 → 4	179 - 191 km/h (111 - 119 mph)
	4 → 3	173 - 186 km/h (107 - 115 mph)
	3 → 2	105 - 116 km/h (65 - 72 mph)
	2 → 1	44 - 50 km/h (27 - 31 mph)
(Throttle valve fully closed)	3 → 4	40 - 45 km/h (25 - 28 mph)
	4 → 3	14 - 19 km/h (9 - 12 mph)
2 position (Throttle valve fully opened)	1 → 2	60 - 67 km/h (37 - 42 mph)
	3 → 2	112 - 123 km/h (70 - 76 mph)
	2 → 1	44 - 50 km/h (27 - 31 mph)
L position (Throttle valve fully opened)	3 → 2	112 - 123 km/h (70 - 76 mph)
	2 → 1	52 - 58 km/h (32 - 36 mph)
Lock-up point	Throttle valve opening 5 %	
3rd gear	Lock-up ON	220 - 234 km/h (137 - 145 mph)
	Lock-up OFF	220 - 234 km/h (137 - 145 mph)
O/D gear	Lock-up ON	75 - 81 km/h (47 - 50 mph)
	Lock-up OFF	64 - 71 km/h (40 - 44 mph)

TORQUE SPECIFICATION

Part tightened	N·m	kgf·cm	ft·lbf
Vehicle speed sensor x Transaxle	5.5	56	49 in.·lbf
Input turbine speed sensor x Transaxle	11	115	8
Counter gear speed sensor x Transaxle	11	115	8
ATF temperature sensor x Transaxle	6.6	67	58 in.·lbf
Oil pan x Transaxle	7.8	80	69 in.·lbf
Control cable x Control shaft	12	120	9
Control shaft x Park/neutral position switch	13	130	9
Park/neutral position switch x Transaxle	Bolt	5.4	48 in.·lbf
	Nut	6.9	61 n.·lbf
Shift solenoid valve x Valve body	12 mm (0.47 in.)	6.6	58 in.·lbf
	45 mm (1.77 in.)	11	8
Valve body x Transaxle	11	110	8
Oil strainer x Valve body	11	110	8
Drain plug x Oil pan	49	500	36
Steering wheel set nut	34	350	25
Front passenger airbag assembly x Instrument panel reinforcement	20	204	15
Floor shift assembly x Body	12	120	9
Hood set bolt	13	130	9
No. 2 cylinder head cover	7.0	71	62 in.·lbf
ECM case set bolt	6.9	70	61 in.·lbf
ECM set bolt	6.9	70	61 in.·lbf
ECM bracket set bolt	18	185	13
ECM bracket set nut	12	120	9
Radiator reservoir set bolt	4.9	50	43 in.·lbf
Ground cable x Transaxle	18	185	13
Starter x Transaxle	37	378	28
Drain plug x Differential	54	550	40
Stabilizer bar link x Shock absorber	44	450	32
Lower suspension arm x Lower ball joint	142	1,450	105
Drive shaft lock nut	218	2,200	159
Steering knuckle x Tie rod end	49	500	33
Drive shaft bearing lock bolt	64	650	47
Power steering gear assembly set bolt	45	459	33
Center member x Body	39	398	29
Center member x Engine front mounting	52	530	38
Suspension member x Body	Front side	113	83
	Rear side	157	116
Engine rear mounting insulator x Engine rear mounting bracket	87	890	64
Engine rear mounting insulator x Suspension member	52	530	38
Engine hanger set bolt	38	387	28
Engine left mounting x Engine left mounting bracket	80	816	59
Torque converter clutch x Drive plate	41	418	30
Transaxle housing x Engine block	See page AX-30		
Drive plate x Crankshaft	88	897	65

AUTOMATIC TRANSAXLE (U341E)**SERVICE DATA**

SS147-01

Line pressure (Wheel locked)	Engine idling		
	D position	372 - 407 kPa (3.8 - 4.2 kgf/cm ² , 54 - 60 psi)	
	R position	588 - 683 kPa (6.0 - 7.0 kgf/cm ² , 85 - 100 psi)	
	at stall (Throttle valve fully opened)		
	D position	1,153 - 1,264 kPa (11.8 - 12.9 kgf/cm ² , 168 - 183 psi)	
	R position	1,589 - 1,761 kPa (16.2 - 18.0 kgf/cm ² , 230 - 256 psi)	
Engine stall revolution	D and R positions	2,050 ± 200 rpm	
Time lag	N → D position	Less than 1.2 seconds	
	N → R position	Less than 1.5 seconds	
Engine idle speed (A/C OFF)	N position	750 ± 50 rpm	
Drive plate runout	Max.	0.20 mm (0.0079 in.)	
Torque converter runout	Max.	0.30 mm (0.0118 in.)	
Torque converter installation distance		More than 20.7 mm (0.815 in.)	
Differential oil seal drive in depth	LH side	2.7 ± 0.5 mm (0.106 ± 0.020 in.)	
	RH side	0 ± 0.5 mm (0 ± 0.020 in.)	
Shift schedule			
D position (Throttle valve fully opened)	1 → 2	49 - 55 km/h (30 - 34 mph)	
	2 → 3	92 - 102 km/h (57 - 63 mph)	
	3 → O/D	148 - 160 km/h (92 - 99 mph)	
	O/D → 3	143 - 155 km/h (89 - 96 mph)	
	3 → 2	86 - 95 km/h (53 - 59 mph)	
	2 → 1	42 - 47 km/h (26 - 29 mph)	
	(Throttle valve fully closed)	3 → O/D	40 - 45 km/h (25 - 28 mph)
		O/D → 3	26 - 31 km/h (16 - 19 mph)
	2 position (Throttle valve fully opened)	1 → 2	49 - 55 km/h (30 - 34 mph)
3 → 2		89 - 99 km/h (55 - 62 mph)	
2 → 1		42 - 47 km/h (26 - 29 mph)	
L position (Throttle valve fully opened)	3 → 2	89 - 99 km/h (55 - 62 mph)	
	2 → 1	46 - 51 km/h (29 - 32 mph)	
Lock-up point 3rd gear	Throttle valve opening 5 %		
	Lock-up ON	57 - 63 km/h (35 - 39 mph)	
	Lock-up OFF	55 - 60 km/h (34 - 37 mph)	
O/D gear	Lock-up ON	51 - 56 km/h (32 - 35 mph)	
	Lock-up OFF	48 - 54 km/h (30 - 34 mph)	

TORQUE SPECIFICATION

Part tightened		N·m	kgf·cm	ft·lbf
Vehicle speed sensor x Transaxle		5.5	56	49 in.·lbf
Direct clutch speed sensor x Transaxle		7.8	80	69 in.·lbf
ATF temperature sensor x Transaxle		10	110	8
Oil pan x Transaxle		7.8	80	69 in.·lbf
Control cable x Control shaft		12	120	9
Control shaft x Park/neutral position switch		13	130	9
Park/neutral position switch x Transaxle	Bolt	5.4	55	48 in.·lbf
	Nut	6.9	70	61 in.·lbf
Shift solenoid valve x Valve body	12 mm (0.47 in.)	6.6	67	58 in.·lbf
	45 mm (1.77 in.)	11	110	8
Valve body x Transaxle		11	110	8
Oil strainer x Valve body		11	110	8
Drain plug x Oil pan		49	500	36
Steering wheel set nut		34	350	25
Front passenger airbag assembly x Instrument panel reinforcement		20	204	15
Floor shift assembly x Body		12	120	9
Hood set bolt		13	130	9
No. 2 cylinder head cover		7.0	71	62 in.·lbf
ECM case set bolt		6.9	70	61 in.·lbf
ECM set bolt		6.9	70	61 in.·lbf
ECM bracket set bolt		18	185	13
ECM bracket set nut		12	120	9
Radiator reservoir set bolt		4.9	50	43 in.·lbf
Ground cable x Transaxle		18	185	13
Starter x Transaxle		37	378	28
Drain plug x Differential		54	550	40
Stabilizer bar link x Shock absorber		44	450	32
Lower suspension arm x Lower ball joint		142	1,450	105
Drive shaft lock nut		216	2,200	159
Steering knuckle x Tie rod end		49	500	33
Drive shaft bearing lock bolt		64	650	47
Power steering gear assembly set bolt		45	459	33
Center member x Body		39	398	29
Center member x Engine front mounting		52	530	38
Suspension member x Body	Front side	113	1,152	83
	Rear side	157	1,601	116
Engine rear mounting insulator x Engine rear mounting bracket		87	890	64
Engine rear mounting insulator x Suspension member		52	530	38
Engine hanger set bolt		38	387	28
Engine left mounting x Engine left mounting bracket		80	816	59
Torque converter clutch x Drive plate		25	250	18
Transaxle housing x Engine block		See page AX-30		
Drive plate x Crankshaft		78	800	58

SUSPENSION AND AXLE

SERVICE DATA

SS01W-04

Cold tire inflation pressure	1ZZ-FE engine models			
	195/60R15 88H P195/60R15 87H	Front, rear	210 kPa (2.1 kgf/cm ² , 30 psi)	
	2ZZ-GE engine models			
	205/55R15 87V P205/55R15 87V 205/50R16 87V	Front, rear	220 kPa (2.2 kgf/cm ² , 31 psi)	
Front Wheel alignment	Vehicle height			
	Tire size: 195/60R15, P195/60R15	Front* ¹	190 mm (7.48 in.)	
		Rear* ²	224 mm (8.82 in.)	
	Tire size: 205/55R15, P205/55R15	Front* ¹	190 mm (7.48 in.)	
		Rear* ²	226 mm (8.90 in.)	
	Tire size: 205/50R16	Front* ¹	193 mm (7.60 in.)	
		Rear* ²	225 mm (8.86 in.)	
	Camber			
		195/60R15, P195/60R15	-0°28' ± 45' (-0.47° ± 0.75°)	
		205/55R15, P205/55R15	-0°25' ± 45' (-0.42° ± 0.75°)	
	205/50R16	-0°29' ± 45' (-0.48° ± 0.75°)		
	Right-left error	45' (0.75°) or less		
Caster				
	195/60R15, P195/60R15	2°07' ± 45' (2.12° ± 0.75°)		
	205/55R15, P205/55R15	2°01' ± 45' (2.02° ± 0.75°)		
	205/50R16	2°02' ± 45' (2.03° ± 0.75°)		
	Right-left error	45' (0.75°) or less		
Steering axis inclination				
	195/60R15, P195/60R15	13°09' ± 45' (13.15° ± 0.75°)		
	205/55R15, P205/55R15	13°04' ± 45' (13.07° ± 0.75°)		
	205/50R16	13°12' ± 45' (13.20° ± 0.75°)		
	Right-left error	45' (0.75°) or less		
Toe-in (total)			0° ± 12' (0° ± 0.2°, 0 ± 2 mm, 0 ± 0.08 in.)	
	Rack end length difference		1.5 mm (0.059 in.) or less	
Wheel angle				
	195/60R15, P195/60R15	Inside wheel	38°41' ± 2° (38.68° ± 2°)	
		Outside wheel: Reference	33°20' (33.33°)	
	205/55R15, P205/55R15	Inside wheel	38°46' ± 2° (38.77° ± 2°)	
		Outside wheel: Reference	33°25' (33.42°)	
	205/50R16	Inside wheel	38°38' ± 2° (38.63° ± 2°)	
		Outside wheel: Reference	33°19' (33.32°)	
Rear wheel alignment	Camber			
		Right-left error	-1°11' ± 45' (-1.18° ± 0.75°) 45' (0.75°) or less	
Toe-in (total)			0°18' ± 12' (0.3° ± 0.2°, 3 ± 2 mm, 0.12 ± 0.08 in.)	
	Toe-in cross measurement difference		6 mm (0.24 in.) or less	
Front axle	Axle bearing backlash		Maximum	
			0.05 mm (0.0020 in.)	
	Axle hub deviation		Maximum	
			0.07 mm (0.0028 in.)	

Front drive shaft	Drive shaft standard length		
	1ZZ-FE (A/T)	RH	851.0 ± 5.0 mm (33.504 ± 0.197 in.)
		LH	565.9 ± 5.0 mm (22.279 ± 0.197 in.)
	1ZZ-FE (M/T) and 2ZZ-GE	RH	845.5 ± 5.0 mm (33.287 ± 0.197 in.)
		LH	563.7 ± 5.0 mm (22.193 ± 0.197 in.)
Front suspension	Lower ball joint turning torque		1.0 – 4.9 N·m (10 – 50 kgf·cm, 8.7 – 43 in·lbf)
	Stabilizer bar link ball joint turning torque		0.05 – 1.0 N·m (0.5 – 10 kgf·cm, 0.4 – 8.7 in·lbf)
Rear axle	Axle bearing backlash	Maximum	0.05 mm (0.0020 in.)
	Axle hub deviation	Maximum	0.07 mm (0.0028 in.)
Rear suspension	Stabilizer bar link ball joint turning torque		0.05 – 1.0 N·m (0.5 – 10 kgf·cm, 0.4 – 8.7 in·lbf)

***1: Front measuring point**

Measure the distance from the ground to the center of the front side lower suspension arm mounting bolt.

***2: Rear measuring point**

Measure the distance from the ground to the center of the rear side lower suspension arm suspension member side set bolt.

TORQUE SPECIFICATION

Part tightened	N·m	kgf·cm	ft·lbf	
FRONT AXLE				
Hub nut	103	1,050	76	
Tie rod end lock nut	74	750	54	
Steering knuckle x Shock absorber	153	1,560	113	
Steering knuckle x Brake caliper	107	1,090	79	
Steering knuckle x Tie rod end	49	500	36	
Axle hub x Drive shaft	216	2,200	159	
Lower ball joint x Lower suspension arm	142	1,450	105	
Lower ball joint x Steering knuckle	103	1,050	76	
Steering knuckle x Dust cover	8.3	85	74 in.·lbf	
ABS speed sensor set bolt	8.0	82	71 in.·lbf	
FRONT DRIVE SHAFT				
Drive shaft center bearing case lock bolt	64	650	47	
FRONT SUSPENSION				
Suspension support x Body	39	400	29	
Suspension support x Piston rod	47	475	34	
Flexible hose x Shock absorber	19	192	14	
ABS speed sensor wire harness x Shock absorber	8.0	82	71 in.·lbf	
Lower suspension arm set bolt	137	1,397	101	
PS gear set bolt	45	459	33	
Engine front mount x Center member	52	530	38	
Engine rear mount x Suspension member	52	530	38	
Suspension member set bolt	Front side Rear side	113 157	1,152 1,600	83 116
Center member front side set bolt	39	400	29	
Stabilizer bar bracket x Suspension member	19	194	14	
Stabilizer bar link set nut	44	449	32	
REAR AXLE				
Hub nut	103	1,050	76	
Brake caliper set bolt	47	475	34	
Axle hub set bolt	56	571	41	
Upper suspension arm x Axle carrier	74	755	55	
Lower suspension arm x Axle carrier	74	755	55	
REAR SUSPENSION				
Shock absorber x Lower suspension arm	140	1,428	103	
ABS speed sensor wire harness x Lower suspension arm	19	194	14	
Spring bracket x Body	80	816	59	
Shock absorber center nut	56	571	41	
Tailpipe set bolt	43	440	32	
Parking brake cable set bolt	5.4	55	48 in.·lbf	
Upper suspension arm x Suspension member	74	755	55	
Lower suspension arm x Suspension member	74	755	55	
Lower suspension arm bracket set bolt	115	1,173	85	

SS-48

SERVICE SPECIFICATIONS - SUSPENSION AND AXLE

Lower suspension arm bracket x Lower suspension arm	110	1,122	81
Stabilizer bar bracket set bolt	18	184	13
Stabilizer bar link set nut	44	449	32

BRAKE

SERVICE DATA

SS011-02

Brake pedal height from asphalt sheet		139.8 - 149.8 mm (5.504 - 5.898 in.)
Brake pedal freeplay		1 - 6 mm (0.04 - 0.24 in.)
Brake pedal reserve distance at 490 N (50 kgf, 110.2 lbf)		More than 85 mm (3.35 in.)
Brake booster push rod to piston clearance (w/ accessory tool)		0 mm (0 in.)
Front brake pad thickness (1ZZ-FE engine)	STD	11.0 mm (0.433 in.)
Front brake pad thickness (2ZZ-GE engine)	STD	11.5 mm (0.453 in.)
Front brake pad thickness	Minimum	1.0 mm (0.039 in.)
Front brake disc thickness	STD	25.0 mm (0.984 in.)
Front brake disc thickness	Minimum	23.0 mm (0.906 in.)
Front brake disc runout	Maximum	0.05 mm (0.0020 in.)
Rear brake pad thickness	STD	10.0 mm (0.394 in.)
Rear brake pad thickness	Minimum	1.0 mm (0.039 in.)
Rear brake disc thickness	STD	9.0 mm (0.354 in.)
Rear brake disc thickness	Minimum	7.5 mm (0.295 in.)
Rear brake disc runout	Maximum	0.15 mm (0.0059 in.)
Rear brake disc inside diameter	STD	173.0 mm (6.811 in.)
Rear brake disc inside diameter	Maximum	174.0 mm (6.850 in.)
Rear brake drum inside diameter	STD	200.0 mm (7.874 in.)
Rear brake drum inside diameter	Maximum	201.0 mm (7.913 in.)
Drum brake shoe lining thickness	STD	4.0 mm (0.157 in.)
Rear brake drum to shoe clearance		0.6 mm (0.024 in.)
Drum brake shoe lining thickness	Minimum	1.0 mm (0.039 in.)
Parking brake shoe lining thickness	STD	2.0 mm (0.079 in.)
Parking brake shoe lining thickness	Minimum	1.0 mm (0.039 in.)
Parking brake lever travel at 196N (20 Kgf, 44.1 lbf)		5 - 8 clicks
Rear brake clearance between rear shoe and lever		Less than 0.35 mm (0.0138 in.)

TORQUE SPECIFICATION

Part tightened	N·m	kgf·cm	ft·lbf
Master cylinder x Brake booster	13	130	9
Brake line union nut	15	155	11
Brake booster clevis lock nut	25	260	19
Brake booster x Pedal bracket	13	130	9
Front disc brake caliper installation bolt	34	350	25
Bleeder plug	8.3	85	74 in·lbf
Front disc brake torque plate x Steering knuckle	107	1,090	79
Front disc brake caliper x Flexible hose	30	310	22
Rear drum brake wheel cylinder x Backing plate	10	100	7
Rear disc brake caliper installation bolt	47	475	34
ABS actuator assembly x Body	19	195	14
ABS actuator x ABS actuator bracket assembly	5.4	55	48 in·lbf
Front speed sensor installation bolt	8.0	82	71 in·lbf
Front speed sensor harness clamp bolt	8.0	82	71 in·lbf
Rear speed sensor harness clamp bolt	Body	8.0	71 in·lbf
	Lower arm	19	14
Pedal bracket x Reinforcement	24	241	17
Brake pedal x Pedal bracket	37	375	27

STEERING

SERVICE DATA

SS167-01

POWER STEERING FLUID		
Fluid level rise	Maximum	5 mm (0.20 in.)
Fluid pressure at idle speed with valve closed	Minimum	7,355 kPa (75 kgf/cm ² , 1,067 psi)
STEERING WHEEL		
Steering wheel freeplay	Maximum	30 mm (1.18 in.)
Steering effort at idle speed	Reference	6.5 N·m (65 kgf·cm, 58 in.-lb)
POWER STEERING VANE PUMP		
Vane pump rotating torque		0.27 N·m (2.8 kgf·cm, 2.4 in.-lb) or less
Vane pump shaft and front housing bushing oil clearance	STD	0.021 – 0.043 mm (0.0008 – 0.0017 in.)
	Maximum	0.07 mm (0.0028 in.)
Vane plate height	Minimum	7.6 mm (0.299 in.)
Vane plate thickness	Minimum	1.405 mm (0.0553 in.)
Vane plate length	Minimum	11.993 mm (0.4722 in.)
Vane plate and vane pump rotor groove clearance	Maximum	0.03 mm (0.0012 in.)
Vane plate length	pump rotor and cam ring mark	
	0	12.001 – 12.003 mm (0.47248 – 0.47256 in.)
	1	11.999 – 12.001 mm (0.47240 – 0.47248 in.)
	2	11.997 – 11.999 mm (0.47232 – 0.47240 in.)
	3	11.995 – 11.997 mm (0.47224 – 0.47232 in.)
	4	11.993 – 11.995 mm (0.47216 – 0.47224 in.)
Spring free length	Minimum	35.8 mm (1.409 in.)
POWER STEERING GEAR		
Steering rack runout	Maximum	0.1 mm (0.004 in.)
Total preload	Turning	0.9 – 1.3 N·m (9 – 13 kgf·cm, 8.0 – 11.5 in.-lb)

TORQUE SPECIFICATION

Part tightened	N·m	kgf·cm	ft·lbf
TILT STEERING COLUMN			
Adjusting nut	See page SR-17		
No. 2 tilt lever lock bolt	5.4	55	48 in.·lbf
Tilt steering support x Column tube	15	155	11
No. 2 intermediate shaft assembly x Main shaft assembly	35	360	26
Column assembly set bolt and nut	21	210	15
No. 2 intermediate shaft assembly x Intermediate extension	35	360	26
Steering wheel set nut	34	350	25
Steering wheel pad set screw (Torx screw)	8.8	90	78 in.·lbf
POWER STEERING VANE PUMP			
Front housing x Rear housing	22	220	16
Rear bracket set bolt	44	440	32
Oil pressure switch	21	210	15
Pressure port union	69	700	51
Suction port union set bolt	12	120	9
PS vane pump assembly set nut	37	370	27
Pressure feed tube clamp set bolt	7.8	80	69 in.·lbf
Pressure feed tube x PS vane pump assembly	37 (44)	375 (450)	27 (33)
POWER STEERING GEAR			
Engine hanger set bolt	38	388	28
Bearing guide nut	40	410	30
Rack housing cap	74	750	54
Rack end x Steering rack	82 (83)	630 (850)	46 (61)
Tie rod end lock nut	74	750	54
Turn pressure tube x Rack housing	20 (25)	200 (250)	14 (18)
Engine rear mount bracket set bolt	64	655	47
Engine rear mount bracket x Engine rear mount insulator	87	890	64
Intermediate extension x Control valve shaft	35	360	26
PS gear assembly set bolt	45	460	33
Front suspension member with lower suspension arm x Frame	Bolt C	113	83
	Bolt D	157	116
	Bolt E	39	29
Engine front mount insulator x Front suspension member	52	530	38
Engine rear mount insulator x Front suspension member	52	530	38
Stabilizer bar link set nut	44	449	32
Lower suspension arm x Lower ball joint	142	1,450	105
Engine hood x Hinge	13	130	9
Tube clamp	7.8	80	69 in.·lbf
Pressure feed and return tubes x PS gear assembly	37 (44)	375 (450)	27 (33)
Tie rod end x Steering knuckle	49	500	36

(): For use without SST

SUPPLEMENTAL RESTRAINT SYSTEM

TORQUE SPECIFICATION

S3041-25

Part tightened	N·m	kgf·cm	ft·lbf
Steering wheel	34	350	25
Steering wheel pad	8.8	90	78 in·lbf
Front passenger airbag assembly x Instrument panel reinforcement	20	205	15
Seatback assembly x Seat adjuster	43	440	32
Seat cushion assembly x Seat adjuster	21	210	15
Front seat x Body	37	375	27
Airbag sensor assembly	20	205	15
Front airbag sensor	20	205	15
Side airbag sensor assembly x body	20	205	15
Door side airbag sensor x door	8.0	82	71 in·lbf

BODY ELECTRICAL

SERVICE DATA

SS000-01

SPEEDOMETER (ON-VEHICLE)	
USA:	
Standard Indication (mph)	Allowable range (mph)
20	19 - 22
40	39 - 42.5
60	59.5 - 63.5
80	80 - 85
100	100 - 105.5
120	120 - 125.5
CANADA:	
Standard indication (km/h)	Allowable range (km/h)
20	18 - 23
40	40 - 44
60	60 - 64.5
80	80 - 85
100	100 - 105
120	120 - 125.5
140	140 - 146
160	160 - 167
TACHOMETER (ON-VEHICLE) DC 13.5 V 25 °C at (77 °F)	
Standard indication	Allowable range
700	700 - 770
1,000	900 - 1,100
2,000	1,850 - 2,150
3,000	2,800 - 3,200
4,000	3,800 - 4,200
5,000	4,800 - 5,200
6,000	5,800 - 6,200
7,000	6,800 - 7,200
FUEL SENDER GAUGE	
Float position mm (In.)	Resistance (Ω)
F: Approx. 75.9 (2.99)	Approx. 3.0
1/2: Approx. 17.2 (0.68)	Approx. 31.6
E: Approx. 50.8 (2.00)	Approx. 110.0
ENGINE COOLANT TEMPERATURE SENDER GAUGE (Resistance)	
Temperature °C (°F)	Resistance (Ω)
50 (122.0)	160 - 240
120 (248.0)	17.1 - 21.2

BODY

TORQUE SPECIFICATION

SS140-01

Part tightened	N·m	kgf·cm	ft·lbf
FRONT BUMPER	-	-	-
Front bumper reinforcement x Body	20	200	14
REAR BUMPER	-	-	-
Rear bumper reinforcement x Body	20	200	14
HOOD	-	-	-
Hood hinge x Hood	13	130	9
Hood lock x Body	6.9	70	61 in.·lbf
FRONT DOOR	-	-	-
Door side airbag sensor x Door panel	8.0	82	71 in.·lbf
Outside rear view mirror x Door panel	8.3	85	74 in.·lbf
Upper window stop x Door panel	11	115	8
Door glass x Window regulator	7.8	80	69 in.·lbf
Lower plate x Door panel	4.9	50	43 in.·lbf
Window regulator x Door panel	8.3	85	74 in.·lbf
Door glass female stabilizer x Door panel	4.9	50	43 in.·lbf
Door lock x Door panel Bolt:	4.9	50	43 in.·lbf
Door lock x Door panel Nut:	5.4	55	48 in.·lbf
Door lock x Door panel Screw:	4.9	50	43 in.·lbf
Outside handle x Door panel	5.4	55	48 in.·lbf
Key cylinder x Outside handle	5.4	55	48 in.·lbf
Door hinge x Body	25	260	19
Door hinge x Door panel	25	260	19
Door lock striker x Body	23	230	17
BACK DOOR	-	-	-
Door lock x Door panel	5.4	55	48 in.·lbf
Door handle x Door panel	5.4	55	48 in.·lbf
Door hinge x Door panel	11	115	8
Door hinge x Body	19	196	14
Door lock striker x Body	11	115	8
BACK DOOR STAY	-	-	-
Back door stay x Body	8.3	85	74 in.·lbf
Back door stay x Door panel	26	270	20
FRONT WIPER AND WASHER	-	-	-
Wiper motor x Wiper link assembly	5.4	55	48 in.·lbf
Wiper motor and link assembly x Body	5.4	55	48 in.·lbf
Wiper arm x Wiper motor and link assembly	32	323	23
REAR WIPER AND WASHER	-	-	-
Rear wiper motor x Door panel	5.4	55	48 in.·lbf
Rear wiper arm x Rear wiper motor	5.4	55	48 in.·lbf
ROOF HEADLINING	-	-	-
Drive gear x Sliding roof assembly	5.4	55	48 in.·lbf

SERVICE SPECIFICATIONS - BODY

INSTRUMENT PANEL	-	-	-	
Steering wheel set nut	34	350	25	
Passenger airbag assembly x Reinforcement	20	204	15	
FRONT SEAT	-	-	-	
Front seat x Body	37	375	27	
Seat cushion assembly x Seat adjuster	21	210	15	
Seatback assembly x Seat adjuster	43	440	32	
Side airbag assembly x Seatback frame	5.5	56	49 in.-lbf	
REAR SEAT	-	-	-	
Seatback assembly x Side hinge	18	185	13	
Seatback assembly x Center hinge	18	185	13	
Side hinge x Body	7.8	80	69 in.-lbf	
Center hinge x Body	18	185	13	
Seatback lock striker x Body	18	185	13	
Seatback lock x Seatback frame	21	210	15	
SEAT BELT	-	-	-	
Front seat outer belt shoulder anchor x Body	43	440	32	
Front seat outer belt floor anchor x Body	43	440	32	
Front seat outer belt retractor x Body	Upper side:	7.5	76	66 in.-lbf
Front seat outer belt retractor x Body	Lower side:	43	440	32
Front seat inner belt x Front seat	43	440	32	
Rear seat outer belt retractor x Belt outer anchor bracket	43	440	32	
Rear seat outer belt floor anchor x Body	43	440	32	
Rear seat inner belt x Body	43	440	32	
Belt outer anchor bracket x Body	43	440	32	

AIR CONDITIONING

SERVICE DATA

SS4B-C1

Refrigerant charge volume		430 ± 30 g (15.17 ± 1.06 oz.)
Idle-up speed (1ZZ-FE)	M/T:	
	Magnetic clutch is not engaged	700 ± 50 rpm
	Magnetic clutch is engaged	900 ± 50 rpm
Idle-up speed (1ZZ-FE)	A/T:	
	Magnetic clutch is not engaged	750 ± 50 rpm
	Magnetic clutch is engaged	900 ± 50 rpm
Idle-up speed (2ZZ-FE)	M/T:	
	Magnetic clutch is not engaged	750 ± 50 rpm
	Magnetic clutch is engaged	850 ± 50 rpm
Idle-up speed (2ZZ-FE)	A/T:	
	Magnetic clutch is not engaged	650 ± 50 rpm
	Magnetic clutch is engaged	850 ± 50 rpm
Magnetic clutch clearance		0.45 ± 0.10 mm (0.018 ± 0.004 in.)

TORQUE SPECIFICATION

Part tightened	N-m	kgf-cm	ft-lbf
Suction hose x Compressor	10	100	7
Discharge hose x Compressor	10	100	7
Discharge hose x Condenser	5.4	55	48 in.-lbf
Compressor x Engine	25	250	18
Liquid tube x Condenser	5.4	55	48 in.-lbf
Evaporator x Expansion valve	5.4	55	48 in.-lbf
Pressure switch x Liquid tube	10	100	7
Pressure plate x Compressor	13.2	135	9
Liquid lines	10	100	7
Discharge lines	10	100	7
Suction lines	10	100	7

DIAGNOSTICS

ENGINE	DI-1	CUSTOMER PROBLEM ANALYSIS CHECK ...	DI-325
HOW TO PROCEED WITH		PRE-CHECK	DI-326
TROUBLESHOOTING	DI-1	DIAGNOSTIC TROUBLE CODE CHART	DI-332
CUSTOMER PROBLEM ANALYSIS CHECK ...	DI-2	PARTS LOCATION	DI-335
PRE-CHECK	DI-3	TERMINALS OF ECU	DI-336
DIAGNOSTIC TROUBLE CODE CHART	DI-14	PROBLEM SYMPTOMS TABLE	DI-338
PARTS LOCATION	DI-19	CIRCUIT INSPECTION	DI-339
TERMINALS OF ECM	DI-20	CRUISE CONTROL SYSTEM	DI-483
PROBLEM SYMPTOMS TABLE	DI-22	HOW TO PROCEED WITH	
CIRCUIT INSPECTION	DI-23	TROUBLESHOOTING	DI-483
AUTOMATIC TRANSAXLE (U240E)	DI-155	CUSTOMER PROBLEM ANALYSIS CHECK ...	DI-484
HOW TO PROCEED WITH		PRE-CHECK	DI-485
TROUBLESHOOTING	DI-155	DIAGNOSTIC TROUBLE CODE CHART	DI-490
CUSTOMER PROBLEM ANALYSIS CHECK ...	DI-156	PARTS LOCATION	DI-491
PRE-CHECK	DI-157	TERMINALS OF ECU	DI-492
DIAGNOSTIC TROUBLE CODE CHART	DI-168	PROBLEM SYMPTOMS TABLE	DI-494
PARTS LOCATION	DI-169	CIRCUIT INSPECTION	DI-496
TERMINALS OF ECM	DI-170	BODY CONTROL SYSTEM	DI-535
PROBLEM SYMPTOMS TABLE	DI-172	HOW TO PROCEED WITH	
CIRCUIT INSPECTION	DI-175	TROUBLESHOOTING	DI-535
AUTOMATIC TRANSAXLE (U341E)	DI-218	CUSTOMER PROBLEM ANALYSIS CHECK ...	DI-536
HOW TO PROCEED WITH		PARTS LOCATION	DI-537
TROUBLESHOOTING	DI-218	TERMINALS OF ECU	DI-539
CUSTOMER PROBLEM ANALYSIS CHECK ...	DI-219	PROBLEM SYMPTOMS TABLE	DI-542
PRE-CHECK	DI-220	CIRCUIT INSPECTION	DI-544
DIAGNOSTIC TROUBLE CODE CHART	DI-231		
PARTS LOCATION	DI-232		
TERMINALS OF ECM	DI-233		
PROBLEM SYMPTOMS TABLE	DI-234		
CIRCUIT INSPECTION	DI-238		
ANTI-LOCK BRAKE SYSTEM WITH			
ELECTRONIC BRAKE FORCE			
DISTRIBUTION (EBD)	DI-274		
HOW TO PROCEED WITH			
TROUBLESHOOTING	DI-274		
CUSTOMER PROBLEM ANALYSIS CHECK ...	DI-275		
PRE-CHECK	DI-276		
DIAGNOSTIC TROUBLE CODE CHART	DI-280		
PARTS LOCATION	DI-281		
TERMINALS OF ECU	DI-282		
PROBLEM SYMPTOMS TABLE	DI-284		
CIRCUIT INSPECTION	DI-285		
SUPPLEMENTAL RESTRAINT SYSTEM ...	DI-324		
HOW TO PROCEED WITH			
TROUBLESHOOTING	DI-324		

1000
1000
)

1000
1000

DI

)

)

ENGINE

HOW TO PROCEED WITH TROUBLESHOOTING

DI-1-02

Troubleshoot in accordance with the procedure on the following page.

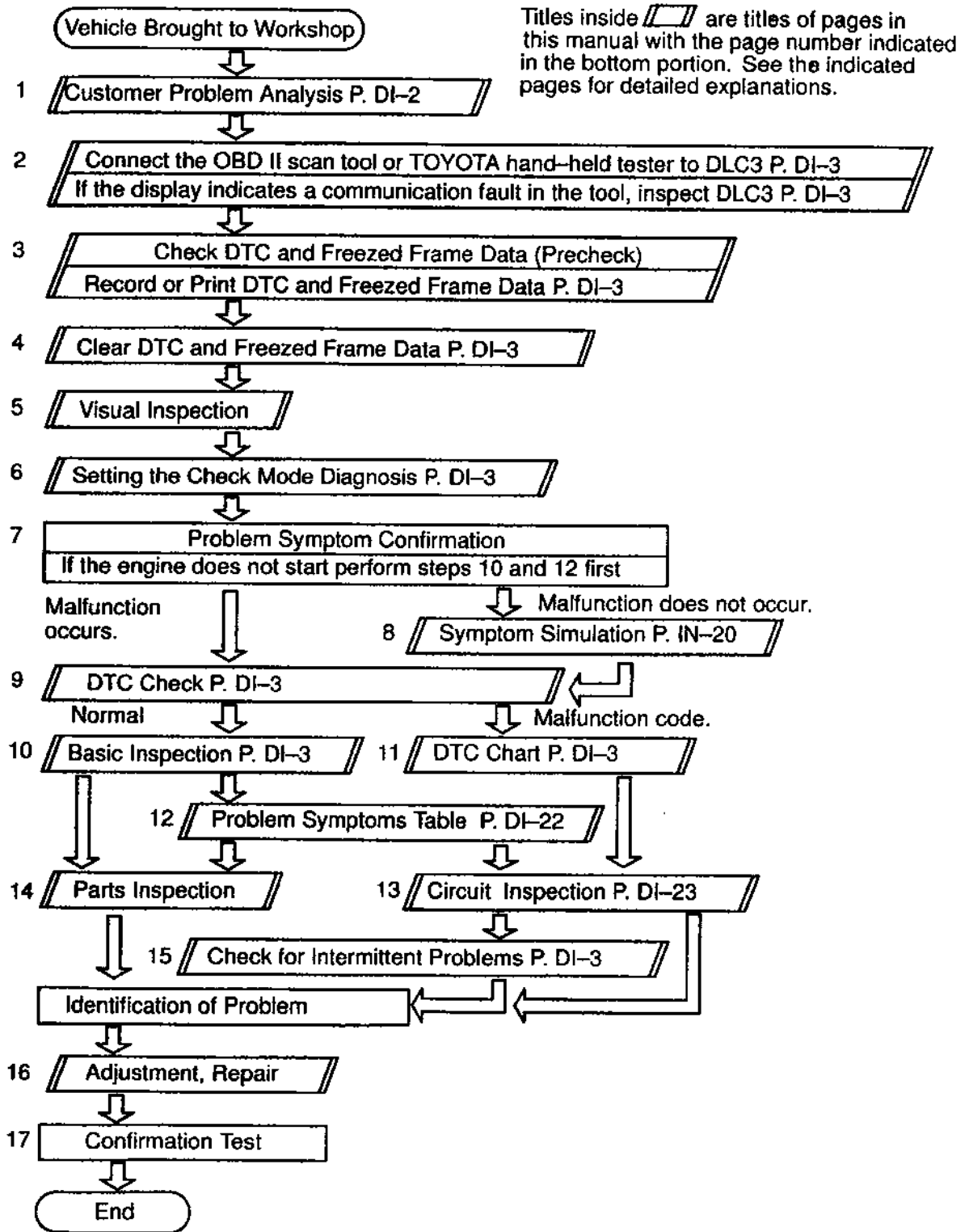

CUSTOMER PROBLEM ANALYSIS CHECK

ENGINE CONTROL SYSTEM Check Sheet

Inspector's Name _____

Customer's Name		Model and Model Year	
Driver's Name		Frame No.	
Date Vehicle Brought In		Engine Model	
License No.		Odometer Reading	km miles

DI

Problem Symptoms	<input type="checkbox"/> Engine does not Start	<input type="checkbox"/> Engine does not crank	<input type="checkbox"/> No initial combustion	<input type="checkbox"/> No complete combustion
	<input type="checkbox"/> Difficult to Start	<input type="checkbox"/> Engine cranks slowly <input type="checkbox"/> Other _____		
	<input type="checkbox"/> Poor Idling	<input type="checkbox"/> Incorrect first idle <input type="checkbox"/> Idling rpm is abnormal <input type="checkbox"/> High (rpm) <input type="checkbox"/> Low (rpm) <input type="checkbox"/> Rough Idling <input type="checkbox"/> Other _____		
	<input type="checkbox"/> Poor Driveability	<input type="checkbox"/> Hesitation <input type="checkbox"/> Back fire <input type="checkbox"/> Muffler explosion (after-fire) <input type="checkbox"/> Surging <input type="checkbox"/> Knocking <input type="checkbox"/> Other _____		
	<input type="checkbox"/> Engine Stall	<input type="checkbox"/> Soon after starting <input type="checkbox"/> After accelerator pedal depressed <input type="checkbox"/> After accelerator pedal released <input type="checkbox"/> During A/C operation <input type="checkbox"/> Shifting from N to D <input type="checkbox"/> Other _____		
	<input type="checkbox"/> Others	_____		

Date Problem Occurred		_____		
Problem Frequency		<input type="checkbox"/> Constant <input type="checkbox"/> Sometimes (times per day/month) <input type="checkbox"/> Once only <input type="checkbox"/> Other _____		
Condition When Problem Occurs	Weather	<input type="checkbox"/> Fine <input type="checkbox"/> Cloudy <input type="checkbox"/> Rainy <input type="checkbox"/> Snowy <input type="checkbox"/> Various/Other _____		
	Outdoor Temperature	<input type="checkbox"/> Hot <input type="checkbox"/> Warm <input type="checkbox"/> Cool <input type="checkbox"/> Cold (approx. _____ °F/ _____ °C)		
	Place	<input type="checkbox"/> Highway <input type="checkbox"/> Suburbs <input type="checkbox"/> Inner city <input type="checkbox"/> Uphill <input type="checkbox"/> Downhill <input type="checkbox"/> Rough road <input type="checkbox"/> Other _____		
	Engine Temperature	<input type="checkbox"/> Cold <input type="checkbox"/> Warming up <input type="checkbox"/> After warming up <input type="checkbox"/> Any temperature <input type="checkbox"/> Other _____		
	Engine Operation	<input type="checkbox"/> Starting <input type="checkbox"/> Just after starting (min.) <input type="checkbox"/> Idling <input type="checkbox"/> Racing <input type="checkbox"/> Driving <input type="checkbox"/> Constant speed <input type="checkbox"/> Acceleration <input type="checkbox"/> Deceleration <input type="checkbox"/> A/C switch ON/OFF <input type="checkbox"/> Other _____		

Condition of MIL		<input type="checkbox"/> Remains on <input type="checkbox"/> Sometimes light up <input type="checkbox"/> Does not light up		
DTC Inspection	Normal Mode (Precheck)	<input type="checkbox"/> Normal <input type="checkbox"/> Malfunction code(s) (code) <input type="checkbox"/> Frozen frame data ()		
	Check Mode	<input type="checkbox"/> Normal <input type="checkbox"/> Malfunction code(s) (code) <input type="checkbox"/> Frozen frame data ()		

PRE-CHECK

1. DIAGNOSIS SYSTEM

(a) Description

- When troubleshooting OBD II vehicles, the only difference from the usual troubleshooting procedure is that you connect to the vehicle the OBD II scan tool complying with SAE J1978 or TOYOTA hand-held tester, and read off various data output from the vehicle's ECM.
- OBD II regulations require that the vehicle's on-board computer lights up the Malfunction Indicator Lamp (MIL) on the instrument panel when the computer detects a malfunction in the emission control system/components or in the power train control components which affect vehicle emissions, or a malfunction in the computer. In addition to the MIL lighting up when a malfunction is detected, the applicable Diagnostic Trouble Code (DTC) prescribed by SAE J2012 are recorded in the ECM memory (See page DI-14).

If the malfunction does not reoccur in 3 consecutive, the MIL goes off automatically but the DTCs remain recorded in the ECM memory.

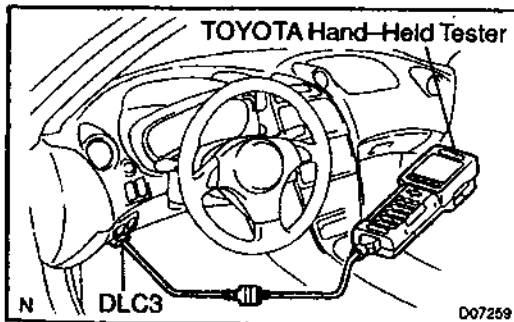
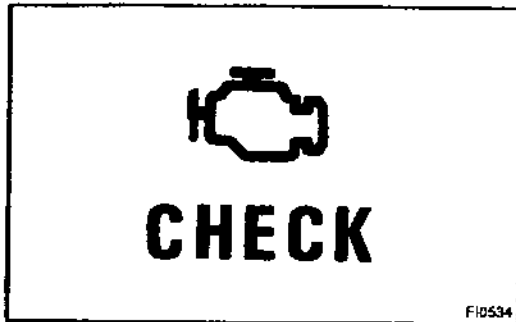

- To check the DTCs, connect the OBD II scan tool or TOYOTA hand-held tester to Data Link Connector 3 (DLC3) on the vehicle. The OBD II scan tool or TOYOTA hand-held tester also enables you to erase the DTCs and check frozen frame data and various forms of engine data (For operating instructions, see the OBD II scan tool's instruction book.). DTCs include SAE controlled codes and manufacturer controlled codes. SAE controlled codes must be set as prescribed by the SAE, while manufacturer controlled codes can be set freely by the manufacturer within the prescribed limits (See DTC chart on page DI-14).

- The diagnosis system operates in normal mode during normal vehicle use. It also has a check mode for technicians to simulate malfunction symptoms and troubleshoot. Most DTCs use 2 trip detection logic* to prevent erroneous detection, and ensure thorough malfunction detection. By switching the ECM to check mode when troubleshooting, the technician can cause the MIL to light up for a malfunction that is only detected once or momentarily (TOYOTA hand-held tester only) (See page DI-3).
- *2 trip detection logic:
When a malfunction is first detected, the malfunction is temporarily stored in the ECM memory (1st trip).

If the same malfunction is detected again during the second drive test, this second detection causes the MIL to light up (2nd trip). (However, the IG switch must be turned OFF between the 1st trip and 2nd trip.)

- Freeze frame data:
Freeze frame data records the engine condition when a misfire (DTC P0300 – P0304) or fuel trim malfunction (DTC P0171, P0172) or other malfunction (first malfunction only), is detected. Because freeze frame data records the engine conditions (fuel system, calculated load, engine coolant temperature, fuel trim, engine speed, vehicle speed, etc.) when the malfunction is detected, when troubleshooting it is useful for determining whether the vehicle was running or stopped, the engine warmed up or not, the air-fuel ratio lean or rich, etc. at the time of the malfunction.

Priorities for troubleshooting:

If troubleshooting priorities for multiple DTCs are given in the applicable DTC chart, these should be followed.

If no instructions are given troubleshoot DTCs according to the following priorities.

- (1) DTCs other than fuel trim malfunction (DTC P0171, P0172) and misfire (DTC P0300 – P0304).
- (2) Fuel trim malfunction (DTC P0171, P0172).
- (3) Misfire (DTC P0300 – P0304).

- (b) Check the DLC3.

The vehicle's ECM uses ISO 9141-2 for communication. The terminal arrangement of DLC3 complies with SAE J1962 and matches the ISO 9141-2 format.

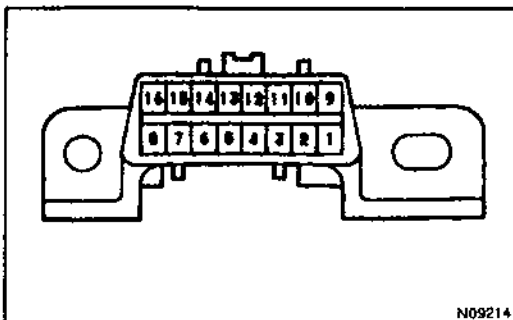

N09214

Terminal No.	Connection / Voltage or Resistance	Condition
2	Bus \oplus Line / Pulse generation	During transmission
4	Chassis Ground \leftrightarrow Body Ground / 1 Ω or less	Always
5	Signal Ground \leftrightarrow Body Ground / 1 Ω or less	Always
16	Battery Positive \leftrightarrow Body Ground / 9 - 14 V	Always

HINT:

If your display shows "UNABLE TO CONNECT TO VEHICLE" when you have connected the cable of the OBD II scan tool or TOYOTA hand-held tester to DLC3, turned the ignition switch ON and operated the scan tool, there is a problem on the vehicle side or tool side.

- If communication is normal when the tool is connected to another vehicle, inspect DLC3 on the original vehicle.
- If communication is still not possible when the tool is connected to another vehicle, the problem is probably in the tool itself, so consult the Service Department listed in the tool's instruction manual.

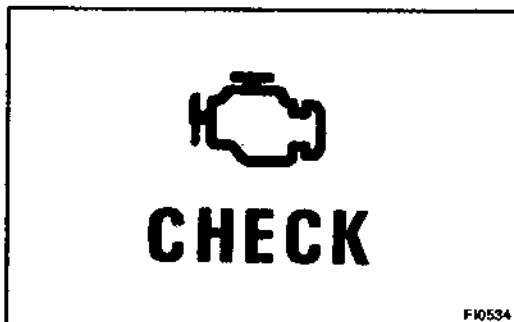
**2. INSPECT DIAGNOSIS (Normal Mode)****(a) Check the MIL.**

- (1) The MIL comes on when the ignition switch is turned ON and the engine is not running.

HINT:

If the MIL does not light up, troubleshoot the combination meter (See page BE-2).

- (2) When the engine started, the MIL should go off. If the lamp remains on, the diagnosis system has detected a malfunction or abnormality in the system.

(b) Check the DTC.**NOTICE:**

- **If there is no DTC in normal mode, check the 1st trip DTC using Continuous Test Results function (Mode 7 for SAE J1979) on the OBDII scan tool or TOYOTA hand-held tester.**
- **TOYOTA hand-held tester only: When the diagnosis system is switched from normal mode to check mode, it erases all DTCs and frozen frame data recorded in normal mode. So before switching modes, always check the DTCs and frozen frame data, and note them down.**
 - (1) Prepare the OBD II scan tool (complying with SAE J1978) or TOYOTA hand-held tester.
 - (2) Connect the OBD II scan tool or TOYOTA hand-held tester to DLC3 under the instrument panel lower pad.
 - (3) Turn the ignition switch ON and turn the OBD II scan tool or TOYOTA hand-held tester switch ON.

- (4) Use the OBD II scan tool or TOYOTA hand-held tester to check the DTCs and freeze frame data, note them down (For operating instructions, see the OBD II scan tool's instruction book.).
- (5) See page DI-3 to confirm the details of the DTCs.

NOTICE:

When simulating symptoms with an OBD II scan tool (excluding TOYOTA hand-held tester) to check the DTCs, use normal mode. For code on the DTC chart subject to "2 trip detection logic", perform the following either action.

- Turn the ignition switch OFF after the symptom is simulated the 1st time. Then repeat the simulation process again. When the problem has been simulated twice, the MIL lights up and the DTCs are recorded in the ECM.
- Check the 1st trip DTC using Mode 7 (Continuous Test Results) for SAE J1979.

- (c) Clear the DTC.

The DTC and freeze frame data will be erased by either action.

- (1) Operating the OBD II scan tool (complying with SAE J1998) or TOYOTA hand-held tester to erase the codes.
- (2) Disconnecting the battery terminals or EFI fuse.

NOTICE:

If the TOYOTA hand-held tester switches the ECM from normal mode to check mode or vice-versa, or if the ignition switch is turned from ON to ACC or OFF during check mode, the DTCs and freeze frame data will be erased.

3. INSPECT DIAGNOSIS (Check Mode)**HINT:**

TOYOTA hand-held tester only:

Compared to the normal mode, the check mode has an increased sensitivity to detect malfunctions.

Furthermore, the same diagnostic items which are detected in the normal mode can also be detected in the check mode.

- (a) Check the DTC.
 - (1) Initial conditions
 - Battery positive voltage 11V or more.
 - Throttle valve fully closed.
 - Transmission in "P" or "N" position.
 - Air conditioning switched OFF.
 - (2) Turn ignition switch OFF.
 - (3) Prepare the TOYOTA hand-held tester.
 - (4) Connect the TOYOTA hand-held tester to the DLC3 under the instrument panel lower pad.

If there is no DTC in normal mode, check the 1st trip DTC using Continuous Test Results function (Mode 7 for SAE J1979) on the OBDII scan tool or TOYOTA hand-held tester.

- (5) Turn the ignition switch ON and switch the TOYOTA hand-held tester ON.

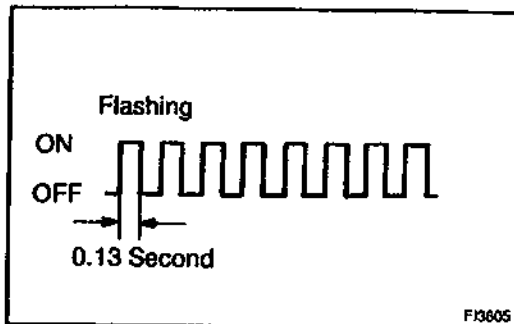

- (6) Switch the TOYOTA hand-held tester normal mode to check mode (Check that the MIL flashes.).

NOTICE:

If the TOYOTA hand-held tester switches the ECM from normal mode to check mode or vice-versa, or if the ignition switch is turned from ON to ACC or LOCK during check mode, the DTCs and freeze frame data will be erased.

- (7) Start the engine (The MIL goes out after the engine start.).
 (8) Simulate the conditions of the malfunction described by the customer.

NOTICE:

Leave the ignition switch ON until you have checked the DTC, etc.

- (9) After simulating the malfunction conditions, use the TOYOTA hand-held tester diagnosis selector to check the DTCs and freeze frame data, etc.

HINT:

Take care not to turn the ignition switch OFF. Turning the ignition switch OFF switches the diagnosis system from check mode to normal mode. So all DTCs, etc. are erased.

- (10) After checking the DTC, inspect the applicable circuit.

4. FAIL-SAFE CHART

If any of the following codes is recorded, the ECM enters fail-safe mode.

DTC No.	Fail-Safe Operation	Fail-Safe Deactivation Conditions
P0100	Ignition timing fixed at 5° BTDC	Returned to normal condition
P0110	Intake air temperature is fixed at 20°C (68°F)	Returned to normal condition
P0115	Engine coolant temperature is fixed at 80° (176°F)	Returned to normal condition
P0120	VTA is fixed at 0°	The following condition must be repeated at least 2 times consecutively VTA \geq 0.1 V and \leq 0.95 V
P0325	Max. timing retardation	Ignition switch OFF
P0336	Fuel cut	Returned to normal condition
P1300	Fuel cut	IGF signal is detected for 4 consecutive ignitions

5. CHECK FOR INTERMITTENT PROBLEMS

TOYOTA HAND-HELD TESTER only:

By putting the vehicle's ECM in check mode, 1 trip detection logic is possible instead of 2 trip detection logic and sensitivity to detect open circuits is increased. This makes it easier to detect intermittent problems.

- (1) Clear the DTC.
- (2) Set the check mode.
- (3) Perform a simulation test (See page IN-20).
- (4) Check the connector and terminal (See page IN-30).
- (5) Handle the connector (See page IN-30).

6. BASIC INSPECTION

When the malfunction code is not confirmed in the DTC check, troubleshooting should be performed in the order for all possible circuits to be considered as the causes of the problems. In many cases, by carrying out the basic engine check shown in the following flow chart, the location causing the problem can be found quickly and efficiently. Therefore, use of this check is essential in engine troubleshooting.

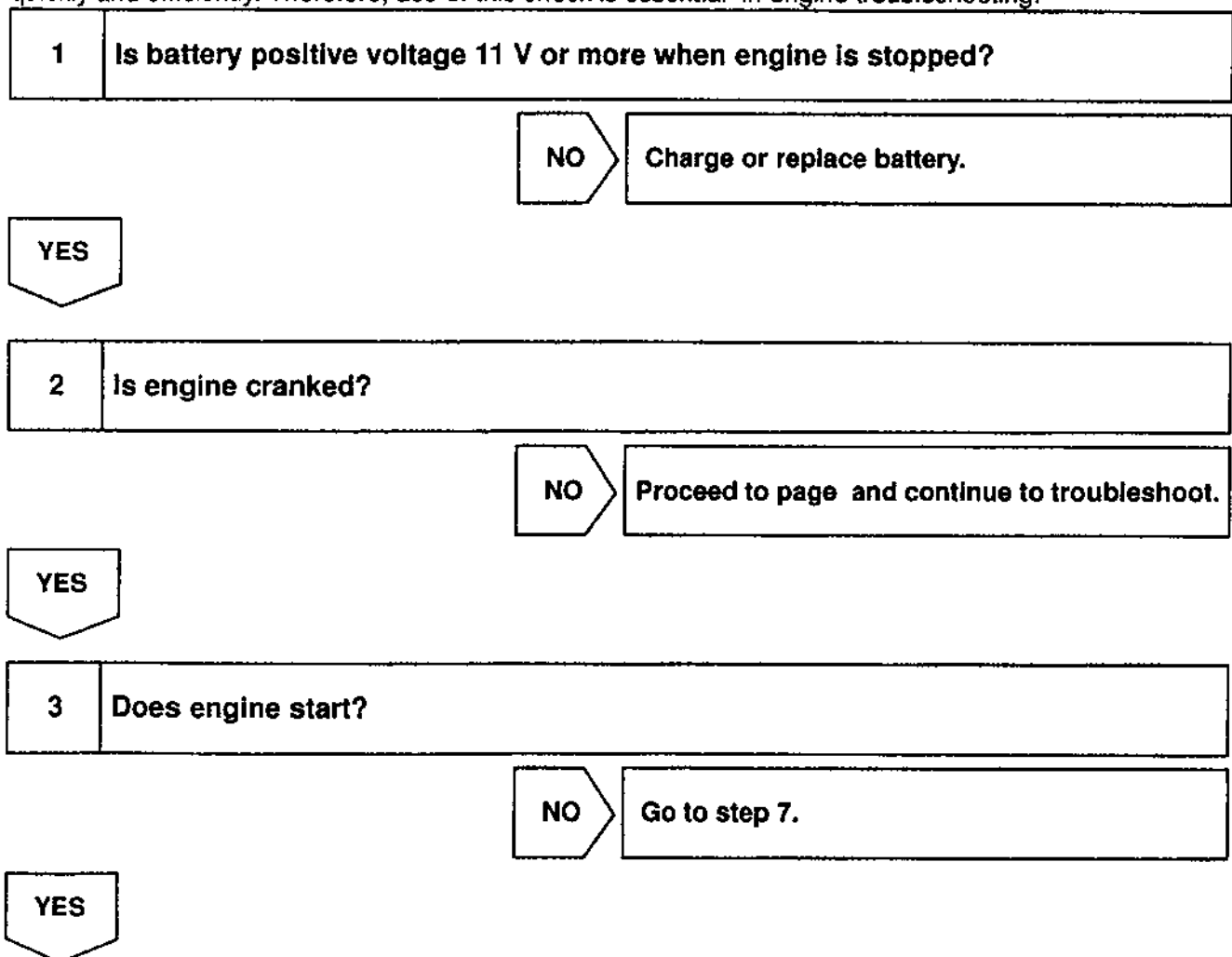
DI

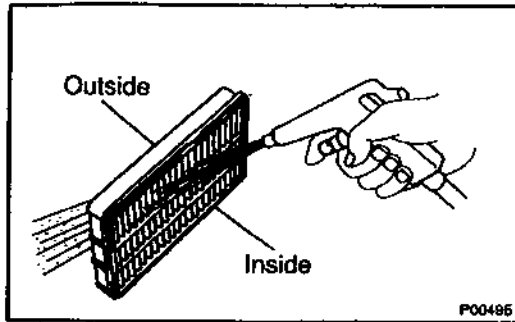
4 Check air filter.**PREPARATION:**

Remove the air filter.

CHECK:

Visual check that the air filter is not dirty or excessive oily.

HINT:

If necessary, clean the filter with compressed air. First blow from inside thoroughly, then blow from outside of the filter.

NG

Repair or replace.

DI

OK

5 Check idle speed.**PREPARATION:**

- Warm up the engine to normal operating temperature.
- Switch off all accessories.
- Switch off air conditioning.
- Shift transmission into "N" position.
- Connect the OBD II scan tool or TOYOTA hand-held tester to DLC3 on the vehicle.

CHECK:

Use CURRENT DATA to check the idle speed.

OK:**Idle speed:**

1ZZ-FE: 650 - 750 rpm

2ZZ-GE (M/T): 750 - 850 rpm

2ZZ-GE (A/T): 700 - 800 rpm

NG

Proceed to problem symptoms table on page DI-22.

OK

6	Check ignition timing.
----------	-------------------------------

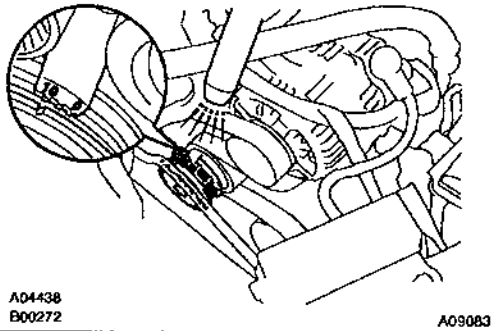
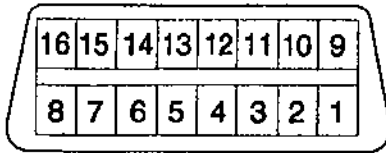
**PREPARATION:**

- (a) Warm up the engine to normal operating temperature.
- (b) Shift transmission into "N" position.
- (c) Keep the engine speed at idle.
- (d) Using SST, connect terminals 13 (TC) and 4 (CG) of the DLC3.
SST 09843 - 18020
- (e) Connect the timing light.

CHECK:

Check ignition timing.

OK:

Ignition timing:

1ZZ-FE: 10 - 18° BTDC at Idle

2ZZ-GE: 8 - 12° BTDC at Idle

DI

NG

Proceed to page and continue to troubleshoot.

OK

Proceed to problem symptoms table on page DI-22.

7	Check fuel pressure.
----------	-----------------------------

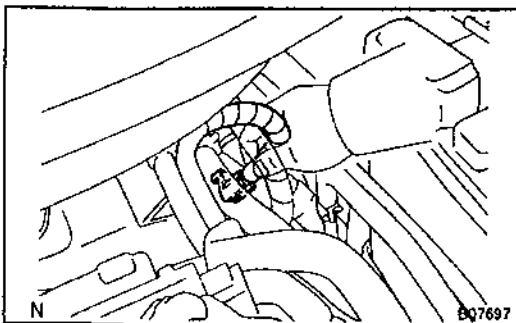
**PREPARATION:**

- (a) Be sure that enough fuel is in the tank.
- (b) Connect the TOYOTA hand-held tester to the DLC3.
- (c) Turn the ignition switch ON and push TOYOTA hand-held tester main switch ON.
- (d) Use ACTIVE TEST mode to operate the fuel pump.
- (e) Please refer to the TOYOTA hand-held tester operator's manual for further details.
- (f) If you have no TOYOTA hand-held tester, connect the positive (+) and negative (-) leads from the battery to the fuel pump connector (See page SF-6).

CHECK:

Check for fuel pressure in the fuel inlet hose when it is pinched off.

HINT:

At this time, you will hear a fuel flowing noise.

NG

Proceed to page SF-6 and continue to troubleshoot.

OK

8

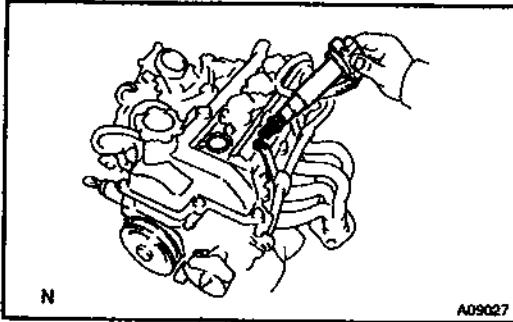
Check for spark.**PREPARATION:**

- (a) Disconnect the high-tension cord from the spark plug.
- (b) Remove the spark plug.
- (c) Install the spark plug the high-tension cord.
- (d) Disconnect the injector connector.
- (e) Ground the spark plug.

CHECK:

Check if spark occurs while engine is being cranked.

NOTICE:

To prevent excess fuel being injected from the injectors during this test, don't crank the engine for more than 5-10 seconds at a time.

NG

Proceed to page IG-1 and continue to troubleshoot.

OK

Proceed to problem symptoms table on page DI-22.

7. ENGINE OPERATING CONDITION

NOTICE:

The values given below for "Normal Condition" are representative values, so a vehicle may still be normal even if its value varies from those listed here. So do not decide whether a part is faulty or not solely according to the "Normal Condition" here.

(a) CARB mandated signals.

TOYOTA hand-held tester display	Measurement Item	Normal Condition*
FUEL SYS #1	Fuel System Bank 1 OPEN: Air-fuel ratio feedback stopped CLOSED: Air-fuel ratio feedback operating	Idling after warming up: CLOSED
CALC LOAD	Calculator Load: Current intake air volume as a proportion of max. intake air volume	Idling: 1ZZ-FE: 11.3 - 16.0 % 2ZZ-GE: 9.1 - 20.0 % Racing without load (2,500rpm): 1ZZ-FE: 12.3 - 17.9 % 2ZZ-GE: 11.0 - 23.0 %
COOLANT TEMP.	Engine Coolant Temp. Sensor Value	After warming up: 80 - 95°C (176 - 203°F)
SHORT FT #1	Short-term Fuel Trim Bank 1	0 ± 20%
LONG FT #1	Long-term Fuel Trim Bank 1	0 ± 20%
ENGINE SPD	Engine Speed	Idling: 1ZZ-FE: 650 - 750 rpm 2ZZ-GE (MT): 750 - 850 rpm 2ZZ-GE (AT): 700 - 800 rpm
VEHICLE SPD	Vehicle Speed	Vehicle Stopped: 0 km/h (0 mph)
IGN ADVANCE	Ignition Advance: Ignition Timing of Cylinder No. 1	Idling: BTDC 10 - 18°
INTAKE AIR	Intake Air Temp. Sensor Value	Equivalent to Ambient Temp.
MAF/AFM	Air Flow Rate Through Mass Air Flow Meter	Idling: 1ZZ-FE: 1.4 - 2.0 gm/sec. 2ZZ-GE: 1.5 - 5.0 gm/sec. Racing without load (2,500 rpm): 1ZZ-FE: 5.4 - 7.9 gm/sec. 2ZZ-GE: 5.0 - 15.0 gm/sec.
THROTTLE POS	Voltage Output of Throttle Position Sensor Calculated as a percentage: 0 V → 0%, 5 V → 100%	Throttle Fully Closed: 6 - 16 % Throttle Fully Open: 64 - 98 %
O2S B1, S1	Voltage Output of Heated Oxygen Sensor Bank 1, Sensor 1	Idling: 0.1 - 0.9 V
O2FT B1, S1	Heated Oxygen Sensor Fuel Trim Bank 1, Sensor 1 (Same as SHORT FT #1)	0 ± 20 %
O2S B1, S2	Voltage Output of Heated Oxygen Sensor Bank 1, Sensor 2	Driving at 50 km/h (31 mph): 0.1 - 0.9 V

*: If no conditions are specifically stated for "Idling", it means the shift lever is at N or P position, the A/C switch is OFF and all accessory switches are OFF.

(b) TOYOTA Enhanced Signals.

TOYOTA hand-held tester display	Measurement Item	Normal Condition*
MISFIRE RPM	Engine RPM for first misfire range	Misfire 0: 0 rpm
MISFIRE LOAD	Engine load for first misfire range	Misfire 0: 9 g/r

INJECTOR	Fuel injection time for cylinder No.1	Idling: 1ZZ-FE: 1.1 - 2.1 ms 2ZZ-GE: 0.8 - 2.0 ms
IAC DUTY RATIO	Intake Air Control Valve Duty Ratio Opening ratio rotary solenoid type IAC valve	Idling: 1ZZ-FE: 25 - 35 % 2ZZ-GE: 22 - 35 %
STARTER SIG	Starter Signal	Cranking: ON
CTP SW	Closed Throttle Position Signal	Throttle fully closed: ON
A/C SIG	A/C Switch Signal	A/C ON: ON
PNP SIG	Park/Neutral Position Switch Signal	P or N position: ON
ELECTCL LOAD SIG	Electrical Load Signal	Defogger S/W ON: ON
STOP LIGHT SW	Stop Light Switch Signal	Stop light switch ON: ON
PS OIL PRESS SW	Power Steering Oil Pressure Switch Signal	Turn steering wheel: ON
FC IDL	Fuel Cut Idle: Fuel cut when throttle valve fully closed, during deceleration	Fuel cut operating: ON
FC TAU	Fuel Cut TAU: Fuel cut during very light load	Fuel cut operating: ON
CYL#1, CYL#2, CYL#3, CYL#4	Abnormal revolution variation for each cylinder	0%
IGNITION	Total number of ignition for every 1,000 revolutions	0 - 2,000 rpm
FUEL PUMP	Fuel Pump Signal	Idling: ON
A/C MAG CLUTCH	A/C switch signal	A/C ON: ON
EVAP (PURGE) VSV	EVAP VSV signal	VSV operating: ON
VVT CTRL	VVT control signal	VVT operating: ON
INTAKE CTRL VSV	Intake control VSV signal	VSV operating: ON
TOTAL FT B1	Total Fuel Trim Bank 1: Average value for fuel trim system of bank 1	Idling: 0.8 - 1.2 V
O2 LR B1, S1	Heated Oxygen Sensor Lean Rich Bank 1, Sensor 1 Response time for oxygen sensor output to switch from lean to rich	Idling after warming up: 0 - 1,000 msec.
O2 RL B1, S1	Heated Oxygen Sensor Rich Lean Bank 1, Sensor 1 Response time for oxygen sensor output to switch from rich to lean	Idling after warming up: 0 - 1,000 msec.

*: If no conditions are specifically stated for "Idling", it means the shift lever is at N or P position, the A/C switch is OFF and all accessory switches are OFF.

DIAGNOSTIC TROUBLE CODE CHART

HINT:

Parameters listed in the chart may not be exactly the same as your reading due to the type of instrument or other factors.

If a malfunction code is displayed during the DTC check in check mode, check the circuit for that code listed in the table below. For details of each code, turn to the page referred to under the "See page" for the respective "DTC No." in the DTC chart.

SAE CONTROLLED:

DTC No.	Detection Item	Trouble Area	MIL*1	Memory
P0100 (DI-23)	Mass Air Flow Circuit Malfunction	<ul style="list-style-type: none"> • Open or short in mass air flow meter circuit • Mass air flow meter • ECM 	○	○
P0101 (DI-27)	Mass Air Flow Circuit Range/Performance Problem	<ul style="list-style-type: none"> • Mass air flow meter 	○	○
P0110 (DI-28)	Intake Air Temp. Circuit Malfunction	<ul style="list-style-type: none"> • Open or short in intake air temp. sensor circuit • Intake air temp. sensor (built into mass air flow meter) • ECM 	○	○
P0115 (DI-33)	Engine Coolant Temp. Circuit Malfunction	<ul style="list-style-type: none"> • Open or short in engine coolant temp. sensor circuit • Engine coolant temp. sensor • ECM 	○	○
P0116 (DI-37)	Engine Coolant Temp. Circuit Range/Performance Problem	<ul style="list-style-type: none"> • Cooling system • Engine coolant temp. sensor 	○	○
P0120 (DI-38)	Throttle/Pedal Position Sensor/Switch "A" Circuit Malfunction	<ul style="list-style-type: none"> • Open or short in throttle position sensor circuit • Throttle position sensor • ECM 	○	○
P0121 (DI-43)	Throttle/Pedal Position Sensor/Switch "A" Circuit Range/Performance Problem	<ul style="list-style-type: none"> • Throttle position sensor • ECM 	○	○
P0125 (DI-44)	Insufficient Coolant Temp. for Closed Loop Fuel Control	<ul style="list-style-type: none"> • Open or short in heated oxygen sensor (bank 1 sensor 1) circuit • Heated oxygen sensor (bank 1 sensor 1) • Air induction system • Fuel pressure • Injector • Gas leakage on exhaust system • ECM 	○	○
P0130 (DI-49)	Heated Oxygen Sensor Circuit Malfunction (Bank 1 Sensor 1) (Except Calif.)	<ul style="list-style-type: none"> • Open or short in heated oxygen sensor circuit • Heated oxygen sensor • Air induction system • EGR system • Fuel pressure • Injector • ECM 	○	○
P0133 (DI-53)	Oxygen Sensor Circuit Slow Response (Bank 1 Sensor 1)	<ul style="list-style-type: none"> • Open or short in heated oxygen sensor circuit • Heated oxygen sensor • Air induction system • EGR system • Fuel pressure • Injector • ECM 	○	○
P0135 (DI-56)	Oxygen Sensor Heater Circuit Malfunction (Bank 1 Sensor 1)	<ul style="list-style-type: none"> • Open or short in heater circuit of heated oxygen sensor • Heated oxygen sensor heater • ECM 	○	○

P0136 (DI-58)	Oxygen Sensor Circuit Malfunction (Bank 1 Sensor 2)	<ul style="list-style-type: none"> • Open or short in heated oxygen sensor circuit • Heated oxygen sensor 	○	○
P0141 (DI-58)	Oxygen Sensor Heater Circuit Malfunction (Bank 1 Sensor 2)	<ul style="list-style-type: none"> • Same as DTC No. P0135 	○	○
P0171 (DI-60)	System too Lean (Fuel Trim)	<ul style="list-style-type: none"> • Air induction system • Injector blockage • Mass air flow meter • Engine coolant temp. sensor • Fuel pressure • Gas leakage on exhaust system • Open or short in heated oxygen sensor (bank 1 sensor 1) circuit • Heated oxygen sensor (bank 1 sensor 1) 	○	○
P0172 (DI-60)	System too Rich (Fuel Trim)	<ul style="list-style-type: none"> • Injector leak, blockage • Mass air flow meter • Engine coolant temp. sensor • Ignition system • Fuel pressure • Gas leakage on exhaust system • Open or short in heated oxygen sensor (bank 1 sensor 1) circuit • Heated oxygen sensor (bank 1 sensor 1) 	○	○
P0300 (DI-64)	Random/Multiple Cylinder Misfire Detected	<ul style="list-style-type: none"> • Open or short in engine wire • Connector connection • Vacuum hose connection 		
P0301 (DI-64)	Cylinder 1 Misfire Detected	<ul style="list-style-type: none"> • Ignition system • Injector 		
P0302 (DI-64)	Cylinder 2 Misfire Detected	<ul style="list-style-type: none"> • Fuel pressure • EGR system • Manifold absolute pressure sensor 	○	○
P0303 (DI-64)	Cylinder 3 Misfire Detected	<ul style="list-style-type: none"> • Engine coolant temp. sensor • Compression pressure 		
P0304 (DI-64)	Cylinder 4 Misfire Detected	<ul style="list-style-type: none"> • Valve clearance • Valve timing • ECM 		
P0325 (DI-71)	Knock Sensor 1 Circuit Malfunction (Bank 1)	<ul style="list-style-type: none"> • Open or short in knock sensor 1 circuit • Knock sensor 1 (looseness) • ECM 	○	○
P0335 (DI-74)	Crankshaft Position Sensor "A" Circuit Malfunction	<ul style="list-style-type: none"> • Open or short in crankshaft position sensor circuit • Crankshaft position sensor • Signal plate (Timing belt guide) • Crankshaft timing pulley • ECM 	○	○
P0340 (DI-76)	Camshaft Position Sensor Circuit Malfunction	<ul style="list-style-type: none"> • Open or short in camshaft position sensor circuit • Camshaft position sensor • Camshaft timing pulley • ECM 	○	○
P0420 (DI-78)	Catalyst System Efficiency Below Threshold (Bank 1)	<ul style="list-style-type: none"> • Gas leakage on exhaust system • Open or short in heated oxygen sensor circuit • Heated oxygen sensor • Three-way catalytic converter 	○	○

P0440 (DI-81)	Evaporative Emission Control System Malfunction	<ul style="list-style-type: none"> • Hose or tube cracked, hole, damaged or loose seal • Fuel tank cap incorrectly installed • Fuel tank cap cracked or damaged • Vacuum hose cracked, hole, blocked, damaged or disconnected • Fuel tank cracked, hole or damaged • Charcoal canister cracked, hole or damaged • Open or short in vapor pressure sensor circuit • Vapor pressure sensor • Fuel tank over fill check valve cracked or damaged • ECM 	○	○
P0441 (DI-87)	Evaporative Emission Control System Incorrect Purge Flow	<ul style="list-style-type: none"> • Vacuum hose cracked, hole, blocked damaged or disconnected • Open or short in vapor pressure sensor circuit • Vapor pressure sensor • Open or short in VSV circuit for EVAP • VSV for EVAP 	○	○
P0446 (DI-87)	Evaporative Emission Control System Vent Control Malfunction	<ul style="list-style-type: none"> • Open or short in VSV circuit for vapor pressure sensor • VSV for vapor pressure sensor • Charcoal canister cracked, hole or damaged • Fuel tank over fill check valve cracked or damaged • ECM 		
P0450 (DI-104)	Evaporative Emission Control System Pressure Sensor Malfunction	<ul style="list-style-type: none"> • Open or short in vapor pressure sensor circuit • Vapor pressure sensor 	○	○
P0451 (DI-104)	Evaporative Emission Control System Pressure Sensor Range/Performance	<ul style="list-style-type: none"> • ECM 		
P0500 (DI-106)	Vehicle Speed Sensor Malfunction	<ul style="list-style-type: none"> • Combination meter • Open or short in vehicle speed sensor circuit • Vehicle speed sensor • ECM 	○	○
P0505 (DI-108)	Idle Control System Malfunction	<ul style="list-style-type: none"> • Open or short in IAC valve circuit • IAC valve is stuck or closed • Open or short in A/C switch circuit • Air induction system • ECM 	○	○

*1: ○ ... MIL lights up

MANUFACTURER CONTROLLED:

DTC No. (See Page)	Detection Item	Trouble Area	MIL*1	Memory
P1300 (DI-114)	Igniter Circuit Malfunction (No.1)	<ul style="list-style-type: none"> • Ignition system • Open or short in IGF1 and IGT1 circuit from No.1 ignition coil with igniter to ECM • No.1 ignition coil with igniter • ECM 	○	○
P1305 (DI-114)	Igniter Circuit Malfunction (No.2)	<ul style="list-style-type: none"> • Ignition system • Open or short in IGF2 and IGT2 circuit from No.2 ignition coil with igniter to ECM • No.2 ignition coil with igniter • ECM 	○	○
P1310 (DI-114)	Igniter Circuit Malfunction (No.3)	<ul style="list-style-type: none"> • Ignition system • Open or short in IGF2 and IGT3 circuit from No.3 ignition coil with igniter to ECM • No.3 ignition coil with igniter • ECM 	○	○
P1315 (DI-114)	Igniter Circuit Malfunction (No.4)	<ul style="list-style-type: none"> • Ignition system • Open or short in IGF1 and IGT4 circuit from No.4 ignition coil with igniter to ECM • No.4 ignition coil with igniter • ECM 	○	○
P1335 (DI-120)	Crankshaft Position Sensor Circuit Malfunction (During engine running)	<ul style="list-style-type: none"> • Open or short in crankshaft position sensor circuit • Crankshaft position sensor • Signal plate • ECM 	○	○
P1346 (DI-121)	VVT Sensor/Camshaft Position Sensor Circuit Range/Performance Problem (Bank 1)	<ul style="list-style-type: none"> • Mechanical system (Jumping teeth of timing belt, belt stretched) • ECM 	○	○
P1349 (DI-123)	VVT System Malfunction (Bank 1)	<ul style="list-style-type: none"> • Valve timing • OCV • VVT controller assembly • ECM 	○	○
P1520 (DI-130)	Stop Light Switch Signal Malfunction	<ul style="list-style-type: none"> • Short in stop light switch signal circuit • Stop light switch • ECM 	○	○
P1600 (DI-133)	ECM BATT Malfunction	<ul style="list-style-type: none"> • Open in back up power source circuit • ECM 	○	○
P1645 (DI-135)	Body ECU Malfunction	<ul style="list-style-type: none"> • Body ECU • A/C ECU • Communication bus 	○	○
P1656 (DI-136)	OCV Circuit Malfunction (for VVT-I)	<ul style="list-style-type: none"> • Open or short in OCV circuit • OCV for VVT-I • ECM 	○	○
P1690*2 (DI-139)	OCV Circuit Malfunction (for VVT-L)	<ul style="list-style-type: none"> • Open or short in OCV circuit • OCV for VVT-L • ECM 	○	○
P1692*2 (DI-143)	OCV Open Malfunction (for VVT-L)	<ul style="list-style-type: none"> • Open or short in OCV circuit • OCV for VVT-L • ECM 	○	○

P1693*2 (DI-143)	OCV Close Malfunction (for VVT-L)	<ul style="list-style-type: none"> • Open or short in OCV circuit • OCV for VVT-L • ECM 	○	○
P1780*3 (DI-145)	Park/Neutral Position Switch Malfunction	<ul style="list-style-type: none"> • Short in park/neutral position switch circuit • Park/neutral position switch • ECM 	○	○

*1: ○ ... MIL lights up

*2: 2ZZ-GE only

*3: AT only

PARTS LOCATION

067J-02

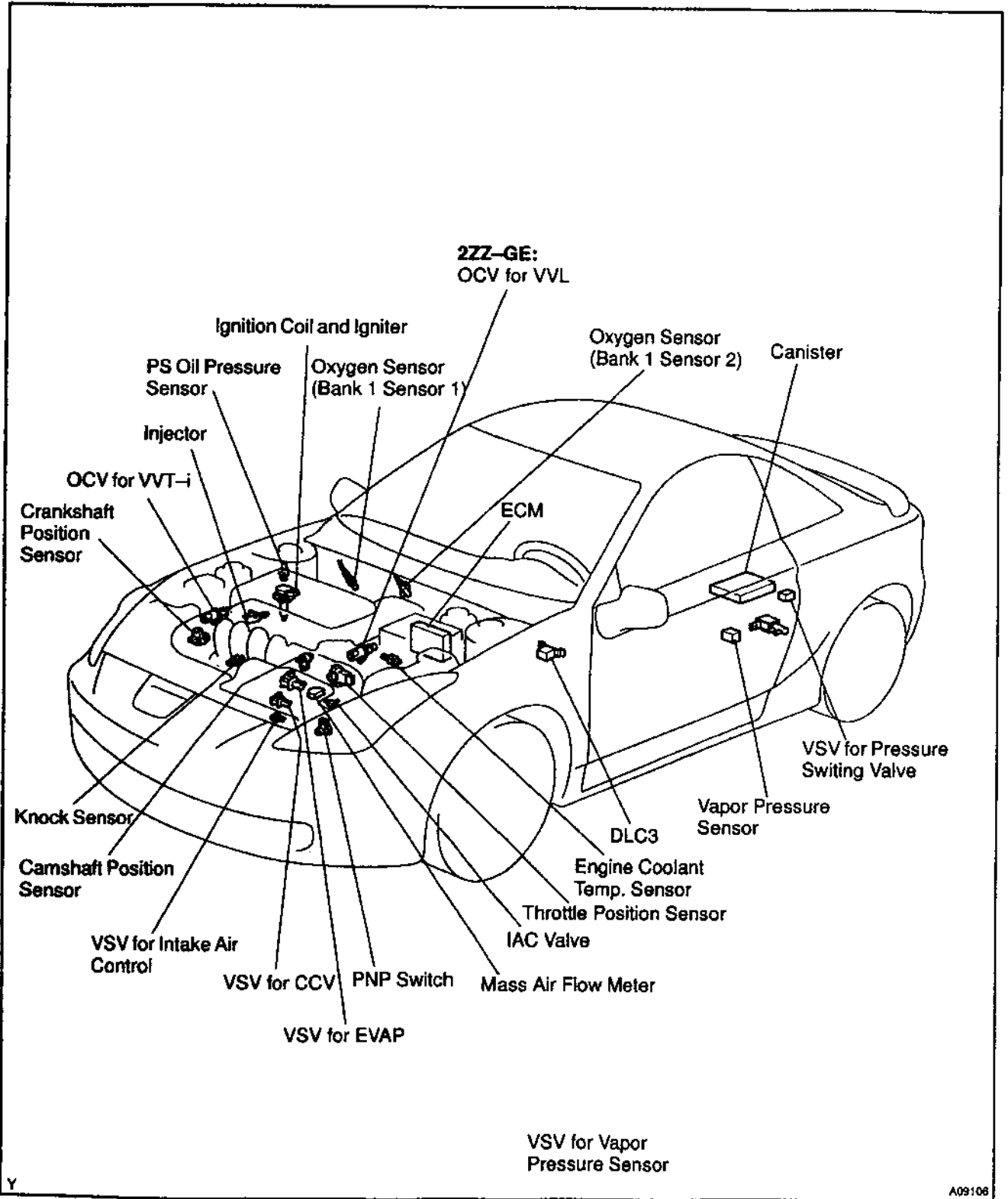

TERMINALS OF ECM

ECM Terminals

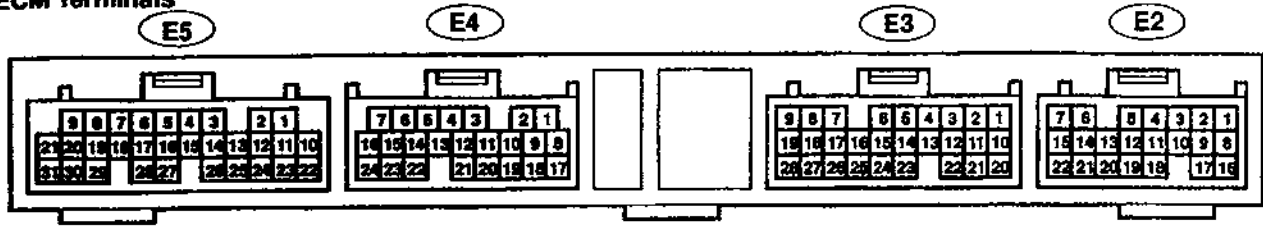

F02094

Symbols (Terminals No.)	Wiring Color	Condition	STD Voltage (V)
BATT (E2-1) - E1 (E4-17)	W ↔ BR	Always	9 - 14
FC (E2-3) - E1 (E4-17)	G-R ↔ BR	IG switch ON	9 - 14
		Idling	0 - 0.3
PTNK (E2-4) - E1 (E4-17)	L-B ↔ BR	IG switch ON, fuel cap taken off	2.9 - 3.7
IGSW (E2-8) - E1 (E4-17)	B-O ↔ BR	IG switch ON	9 - 14
W (E2-15) - E1 (E4-17)	R-B ↔ BR	Idling	9 - 14
		IG switch ON	Below 3.0
+B (E2-16) - E1 (E4-17)	B-R ↔ BR	IG switch ON	9 - 14
STP (E3-6) - E1 (E4-17)	G-W ↔ BR	IG switch ON, brake pedal depressed	7.5 - 14
		IG switch ON, brake pedal depressed	Below 1.5
F/PS (E3-8) - E1 (E4-17)	P ↔ BR	IG switch ON	Below 1.5
VSV (E3-9) - E1 (E4-17)	R-L ↔ BR	IG switch ON	9 - 14
STA (E3-11) - E1 (E4-17)	L ↔ BR	Cranking	6.0 or more
HT1B (E3-16) - E03 (E2-7)	Y-G ↔ W-B	Idling	Below 3.0
		IG switch ON	9 - 14
MREL (E3-21) - E1 (E4-17)	L-B ↔ BR	IG switch ON	9 - 14
SPD (E3-22) - E1 (E4-17)	W-R ↔ BR	IG switch ON, rotate driving wheel slowly	Pulse generation
OX1B (E3-25) - E2 (E4-18)	W ↔ BR	Maintain engine speed at 2,500 rpm for 2 min. after warming up	Pulse generation (See page DI-78)
TACH (E3-27) - E1 (E4-17)	BR-W ↔ BR	Idling	Pulse generation
VC (E4-2) - E2 (E4-18)	R ↔ BR	IG switch ON	9 - 14
		Idling	Below 3.0
HT1A (E4-3) - E03 (E2-7)	Y-R ↔ BR	IG switch ON	9 - 14
		Idling	Below 3.0
EVP1 (E4-4) - E01 (E5-21)	G-O ↔ W-B	IG switch ON	9 - 14
OVL+ (E4-7) - OVL- (E4-6)	L-W ↔ L-B	Engine speed at 6,000 rpm or more	9 - 14
VG (E4-11) - EVG (E4-1)	G-W ↔ Y-G	Idling, A/C switch OFF	1.1 - 1.5
OX1A (E4-12) - E2 (E4-18)	B ↔ BR	Maintain engine speed at 2,500 rpm for 2 min. after warming up	Pulse generation (See page DI-78)
THW (E4-14) - E2 (E4-18)	G ↔ BR	Idling, Engine coolant temp. at 80 °C (176 °F)	0.2 - 1.0
NE+ (E4-16) - NE- (E4-24)	O ↔ W	Idling	Pulse generation (See page DI-74)
OSW (E4-21) - E1 (E4-17)	GR ↔ BR	Idling	9 - 14
THA (E4-22) - E2 (E4-18)	L-R ↔ BR	Idling, intake air temp. 20 °C (68 °F)	0.5 - 3.4

Symbols (Terminals No.)	Wiring Color	Condition	STD Voltage (V)
VTA (E4 - 23) - E2 (E4 - 18)	B-W ↔ BR	IG switch ON, throttle valve fully closed	0.3 - 1.0
		IG switch ON, throttle valve fully open	3.2 - 4.9
#10 (E5 - 1) - E01 (E5 - 21)	R ↔ W-B	IG switch ON	9 - 14
		Idling	Pulse generation (See page DI-64)
#20 (E5 - 2) - E01 (E5 - 21)	R-L ↔ W-B	IG switch ON	9 - 14
		Idling	Pulse generation (See page DI-64)
#30 (E5 - 3) - E01 (E5 - 21)	R-W ↔ W-B	IG switch ON	9 - 14
		Idling	Pulse generation (See page DI-64)
#40 (E5 - 4) - E01 (E5 - 21)	R-B ↔ W-B	IG switch ON	9 - 14
		Idling	Pulse generation (See page DI-64)
IGT1 (E5 - 10) - E1 (E4 - 17)	R-B ↔ BR	Idling	Pulse generation (See page DI-114)
IGT2 (E5 - 11) - E1 (E4 - 17)	R-W ↔ BR	Idling	Pulse generation (See page DI-114)
IGT3 (E5 - 12) - E1 (E4 - 17)	G-R ↔ BR	Idling	Pulse generation (See page DI-114)
IGT4 (E5 - 13) - E1 (E4 - 17)	R-Y ↔ BR	Idling	Pulse generation (See page DI-114)
CCV (E5 - 17) - E1 (E4 - 17)	V-W ↔ BR	IG switch ON	9 - 14
RSO (E5 - 18) - E01 (E5 - 21)	B-W ↔ W-B	IG switch ON, disconnect E4 of E4 connector	9 - 14
MOPS (E5 - 22) - E1 (E5 - 17)	Y-B ↔ BR	Idling	9 - 14
OCV+ (E5 - 24) - OCV- (E5 - 23)	G-O ↔ W	IG switch ON	Pulse generation (See page DI-123)
IGF (E5 - 25) - E1 (E4 - 17)	B-Y ↔ BR	IG switch ON	4.5 - 5.5
		Idling	Pulse generation (See page DI-114)
KNK1 (E5 - 27) - E1 (E4 - 17)	W ↔ BR	Idling	Pulse generation (See page DI-71)
PS (E5 - 28) - E1 (E4 - 17)	P ↔ BR	IG switch ON	9 - 14

*1: Only for A/T models.

*2: Only for 2ZZ-GE models.

PROBLEM SYMPTOMS TABLE

Symptom	Suspect Area	See page
Engine does not crank (Does not start)	1. Starter 2. starter relay	ST-2 ST-17
No initial combustion (Does not start)	1. ECM power source circuit 2. Fuel pump control circuit 3. Engine control module (ECM)	DI-146 DI-149 IN-30
No complete combustion (Does not start)	1. Fuel pump control circuit	DI-149
Engine cranks normally (Difficult to start)	1. Starter signal circuit 2. Fuel pump control circuit 3. Compression	- DI-149 EM-3
Cold engine (Difficult to start)	1. Starter signal circuit 2. Fuel pump control circuit	- DI-149
Hot engine (Difficult to start)	1. Starter signal circuit 2. Fuel pump control circuit	- DI-149
High engine idle speed (Poor idling)	1. A/C switch circuit 2. ECM power source circuit	AC-68 DI-146
Low engine idle speed (Poor idling)	1. A/C switch circuit 2. Fuel pump control circuit	AC-68 DI-149
Rough idling (Poor idling)	1. Compression 2. Fuel pump control circuit	EM-3 DI-149
Hunting (Poor idling)	1. ECM power source circuit 2. Fuel pump control circuit	DI-146 DI-149
Hesitation/Poor acceleration (Poor driveability)	1. Fuel pump control circuit 2. A/T faulty	DI-149 U240E DI-172 U341E DI-234
Surging (Poor driveability)	1. Fuel pump control circuit	DI-149
Soon after starting (Engine stall)	1. Fuel pump control circuit	DI-149
During A/C operation (Engine stall)	1. A/C switch circuit 2. Engine control module (ECM)	AC-68 IN-30

CIRCUIT INSPECTION

D030-07

DTC	P0100	Mass Air Flow Circuit Malfunction
------------	--------------	------------------------------------------

CIRCUIT DESCRIPTION

The mass air flow meter uses a platinum hot wire. The hot wire air flow meter consists of a platinum hot wire, thermistor and a control circuit installed in a plastic housing. The hot wire air flow meter works on the principle that the hot wire and thermistor located in the intake air bypass of the housing detect any changes in the intake air temp.

The hot wire is maintained at the set temp. by controlling the current flow through the hot wire. This current flow is then measured as the output voltage of the air flow meter.

The circuit is constructed so that the platinum hot wire and thermistor provide a bridge circuit, with the power transistor controlled so that the potential of A and B remains equal to maintain the set temp.

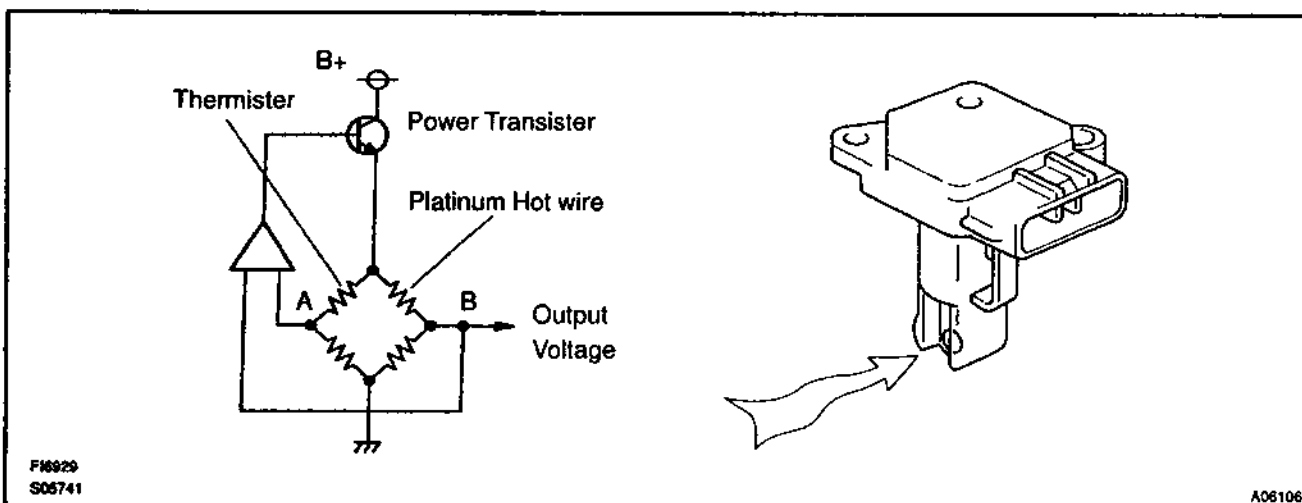

DTC No.	DTC Detecting Condition	Trouble Area
P0100	Open or short in mass air flow meter circuit with more than 3 sec. engine speed 4,000 rpm or less	<ul style="list-style-type: none"> • Open or short in mass air flow meter circuit • Mass air flow meter • ECM

If the ECM detects DTC "P0100" it operates the fail-safe function, keeping the ignition timing and injection volume constant and making it possible to drive the vehicle.

HINT:

After confirming DTC P0100 use the OBD II scan tool or TOYOTA hand-held tester to confirm the mass air flow ratio from "CURRENT DATA".

Mass Air Flow Value (gm/sec.)	Malfunction
0.0	<ul style="list-style-type: none"> • Mass air flow meter power source circuit open • VG circuit open or short
271.0 or more	<ul style="list-style-type: none"> • E2G circuit open

WIRING DIAGRAM

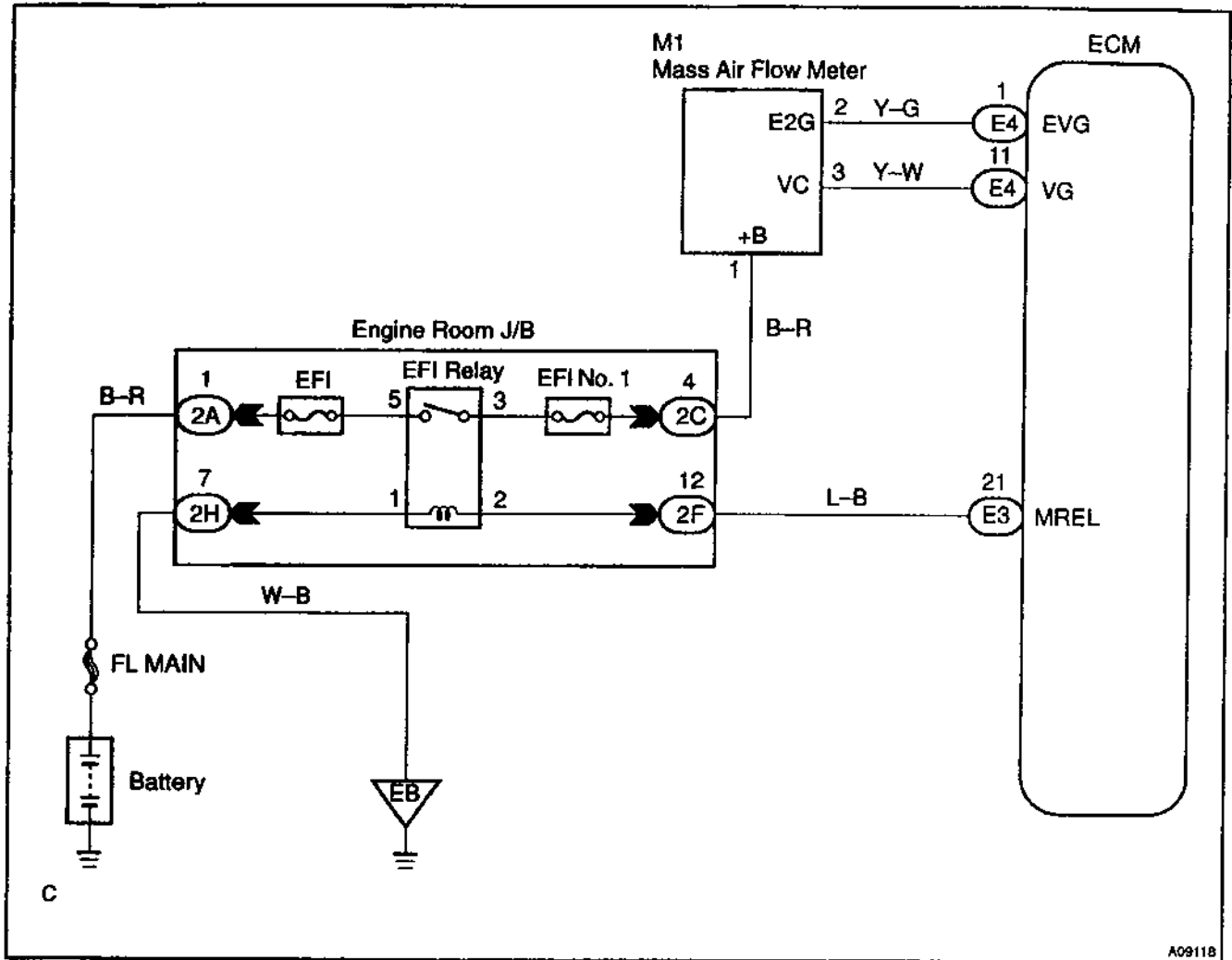

A0911B

INSPECTION PROCEDURE

HINT:

Read freeze frame data using TOYOTA hand-held tester or OBD II scan tool. Because freeze frame records the engine conditions when the malfunction is detected, when troubleshooting it is useful for determining whether the vehicle was running or stopped, the engine warmed up or not, the air-fuel ratio lean or rich, etc. at the time of the malfunction.

- | | |
|----------|---------------------------------------------------------------------------------------------------|
| 1 | Connect OBD II scan tool or TOYOTA hand-held tester, and read value of mass air flow rate. |
|----------|---------------------------------------------------------------------------------------------------|

PREPARATION:

- (a) Connect the OBD II scan tool or TOYOTA hand-held tester to the DLC3.
- (b) Turn ignition switch ON and push the OBD II scan tool or TOYOTA hand-held tester main switch ON.
- (c) Start the engine.

CHECK:

Read mass air flow rate on the OBD II scan tool or TOYOTA hand-held tester.

RESULT:

	Type I	Type II
Mass air flow rate (gm/sec.)	0.0	271.0 or more

Type I	Go to step 2.
Type II	Go to step 5.

2 Check voltage of mass air flow meter power source.

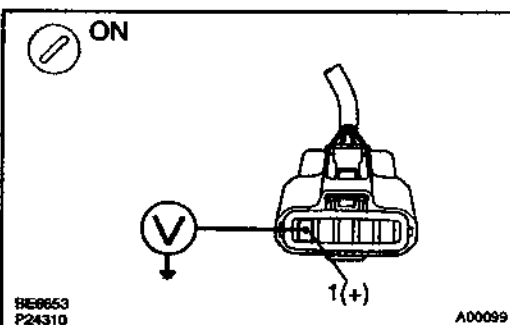

PREPARATION:

- (a) Disconnect the mass air flow meter connector.
- (b) Turn ignition switch ON.

CHECK:

Measure voltage between terminal 4 of mass air flow meter connector and body ground.

OK:

Voltage: 9 - 14 V

NG Check for open in harness and connector between EFI main relay (Marking: EFI) and mass air flow meter (See page IN-30).

OK

3 Check voltage between terminal VG of ECM connector and body ground.

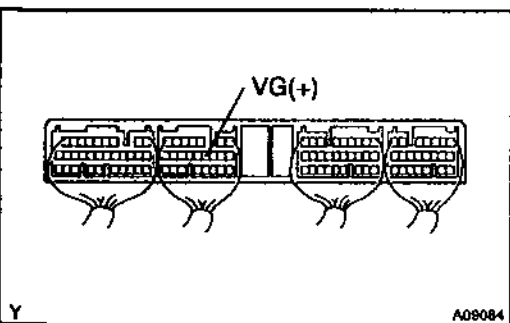

PREPARATION:

- (a) Remove the ECM cover.
- (b) Start the engine.

CHECK:

Measure voltage between terminal VG of ECM and body ground while engine is idling.

OK:

Voltage: 1.1 - 1.5 V (P or N position and A/C switch OFF)

OK Check and replace ECM (See page IN-30).

NG

- 4 Check for open and short in harness and connector between mass air flow meter and ECM (See page IN-30).**

NG

Repair or replace harness or connector.

OK

Replace mass air flow meter.

- 5 Check continuity between terminal E2 of ECM connector and body ground.**

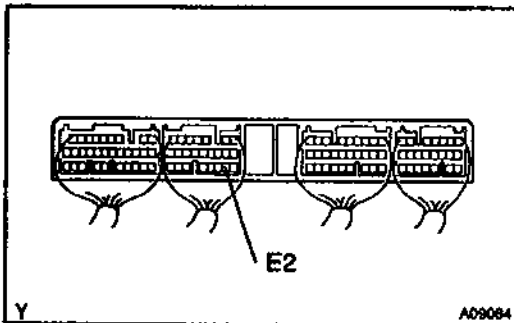

PREPARATION:

Remove the ECM cover.

CHECK:

Check continuity between terminal E2 of ECM connector and body ground.

OK:

Continuity (1Ω or less)

NG

Check and replace ECM (See page IN-30).

OK

- 6 Check for open in harness and connector between mass air flow meter and ECM (See page IN-30).**

NG

Repair or replace harness or connector.

OK

Replace mass air flow meter.

DTC	P0101	Mass Air Flow Circuit Range/Performance Problem
------------	--------------	--------------------------------------------------------

CIRCUIT DESCRIPTION

Refer to DTC P0100 (Mass Air Flow Circuit Malfunction) on page DI-23.

DTC No.	DTC Detecting Condition	Trouble Area
P0101	Conditions (a), (b) and (c) continue 10 sec. or more with engine speed 900 rpm or less: (2 trip detection logic) (a) Throttle valve fully closed (b) Mass air flow meter output > 2.2 V (c) THW > 70°C	• Mass air flow meter
	Conditions (a) and (b) continue 10 sec. or more with engine speed 1,500 rpm or more: (2 trip detection logic) (a) VTA \geq 0.63 V (b) Mass air flow meter output < 1.06 V	

WIRING DIAGRAM

Refer to DTC P0100 (Mass Air Flow Circuit Malfunction) on page DI-23 for the WIRING DIAGRAM.

INSPECTION PROCEDURE

HINT:

Read freeze frame data using TOYOTA hand-held tester or OBD II scan tool. Because freeze frame records the engine conditions when the malfunction is detected, when troubleshooting it is useful for determining whether the vehicle was running or stopped, the engine warmed up or not, the air-fuel ratio lean or rich, etc. at the time of the malfunction.

1	Are there any other codes (besides DTC P0101) being output?
----------	--------------------------------------------------------------------

NO

Replace mass air flow meter.

YES

Go to relevant DTC chart.

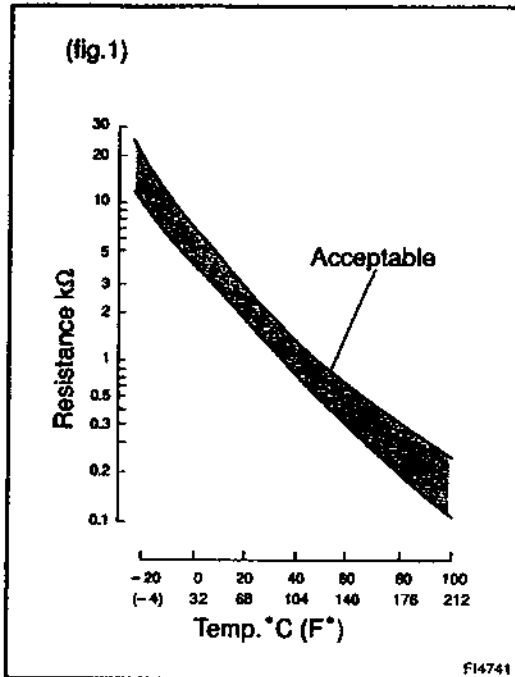
DTC**P0110****Intake Air Temp. Circuit Malfunction****CIRCUIT DESCRIPTION**

The intake air temp. sensor is built into the mass air flow meter and senses the intake air temperature.

A thermistor built in the sensor changes the resistance value according to the intake air temperature, the lower the intake air temperature, the greater the thermistor resistance value, and the higher the intake air temperature, the lower the thermistor resistance value (See fig.1).

The air intake temperature sensor is connected to the ECM (See below). The 5V power source voltage in the ECM is applied to the intake air temp. sensor from the terminal THA via a resistor R.

That is, the resistor R and the intake air temp. sensor are connected in series. When the resistance value of the intake air temp. sensor changes in accordance with changes in the intake air temperature, the potential at terminal THA also changes. Based on this signal, the ECM increases the fuel injection volume to improve driveability during cold engine operation.

If the ECM detects the DTC "P0110", it operates the fail safe function in which the intake air temperature is assumed to be 20°C (68°F).

DTC No.	DTC Detecting Condition	Trouble Area
P0110	Open or short in intake air temp. sensor circuit	<ul style="list-style-type: none"> • Open or short in intake air temp. sensor circuit • Intake air temp. sensor (built into mass air flow meter) • ECM

HINT:

After confirming DTC P0110, use the OBD II scan tool or TOYOTA hand-held tester to confirm the intake air temperature from CURRENT DATA.

Temperature Displayed	Malfunction
-40°C (-40°F)	Open circuit
140°C (284°F) or more	Short circuit

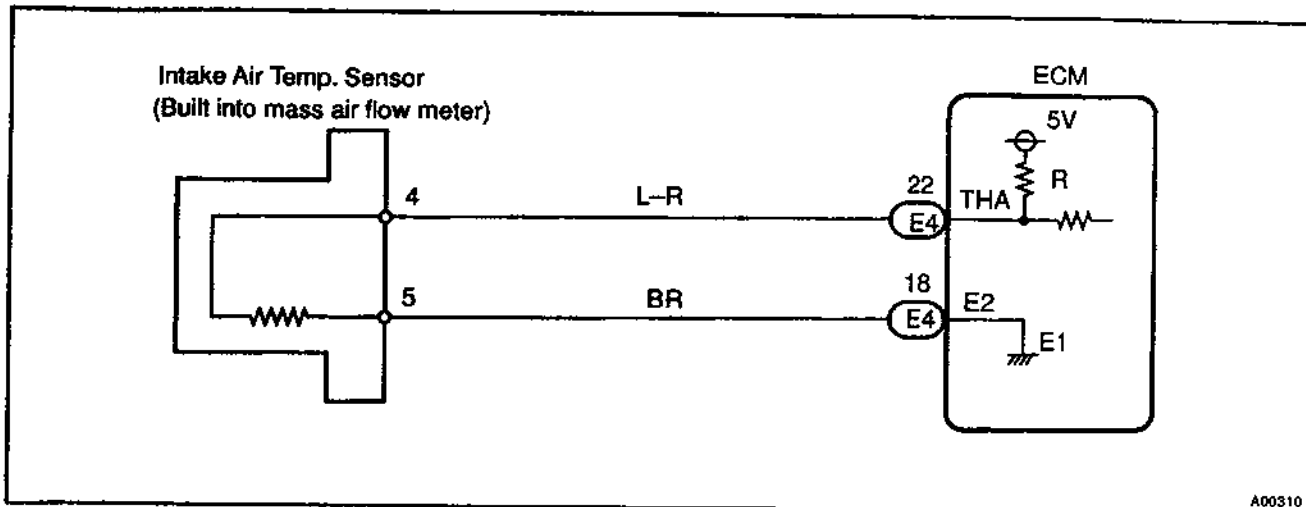
WIRING DIAGRAM**INSPECTION PROCEDURE****HINT:**

- If DTC P100 (Mass Air Flow Meter Circuit Malfunction), P0101 (Mass Air Flow meter Circuit Range/Performance Problem), P0110 (Intake Air Temp. Circuit Malfunction), P0115 (Engine Coolant Temp. Circuit Malfunction) and P0120 (Throttle/Pedal Position Sensor/Switch "A" Circuit Malfunction) are output simultaneously, E2 (sensor ground) may be open.
- Read freeze frame data using TOYOTA hand-held tester or OBD II scan tool. Because freeze frame records the engine conditions when the malfunction is detected, when troubleshooting it is useful for determining whether the vehicle was running or stopped, the engine warmed up or not, the air-fuel ratio lean or rich, etc. at the time of the malfunction.

- 1** Connect OBD II scan tool or TOYOTA hand-held tester, and read value of Intake air temperature.

PREPARATION:

- (a) Connect the OBD II scan tool or TOYOTA hand-held tester to DLC3.
 (b) Turn the ignition switch ON and push the OBD II scan tool or TOYOTA hand-held tester main switch ON.

CHECK:

Read temperature value on the OBD II scan tool or TOYOTA hand-held tester.

OK:

Same as actual air Intake temperature.

HINT:

- If there is open circuit, OBD II scan tool or TOYOTA hand-held tester indicates -40°C (-40°F).
- If there is short circuit, OBD II scan tool or TOYOTA hand-held tester indicates 140°C (284°F) or more.

NG

-40°C (-40°F)Go to step 2.
 140°C (284°F) or moreGo to step 4.

OK

Check for intermittent problems
 (See page DI-3).

- 2** Check for open in harness or ECM.

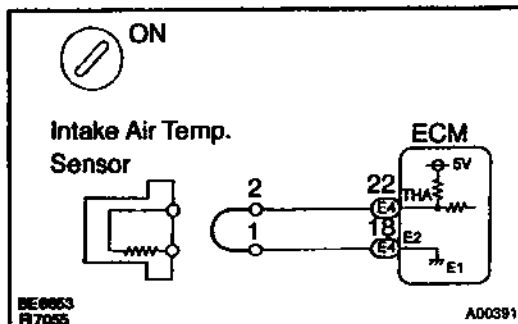
**PREPARATION:**

- (a) Disconnect the intake temp. sensor connector.
 (b) Connect sensor wire harness terminals together.
 (c) Turn the ignition switch ON.

CHECK:

Read temp. value on the OBD II scan tool or TOYOTA hand-held tester.

OK:

Temp. value: 140°C (284°F) or more

OK

Confirm good connection at sensor. If OK, replace intake air temp. sensor.

NG

3 Check for open in harness or ECM.

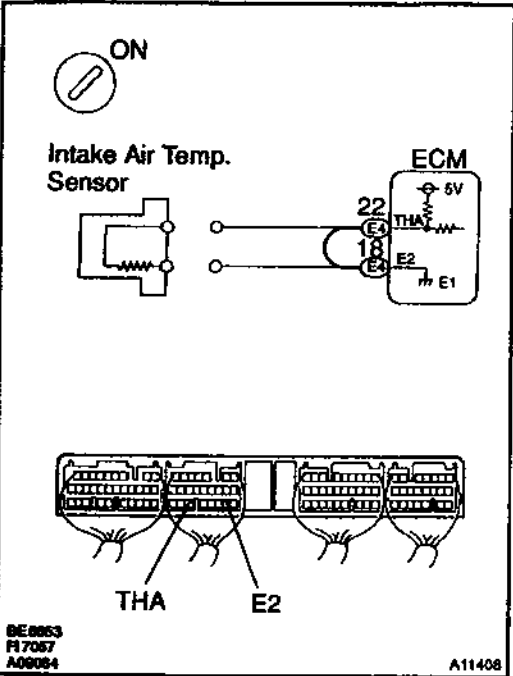

PREPARATION:

- (a) Remove the ECM cover.
- (b) Connect between terminals THA and E2 of the ECM connector.

HINT:

In take air temp. sensor connector is disconnected. Before checking, do a visual and contact pressure check for the ECM connector (See page IN-30).

- (c) Turn the ignition switch ON.

CHECK:

Read temperature value on the OBD II scan tool or TOYOTA hand-held tester.

OK:

Temperature value: 140°C (284°F) or more

OK Open in harness between terminals E2 or THA, repair or replace harness.

NG

Confirm good connection at ECM. If OK, check and replace ECM (See page IN-30).

4 Check for short in harness and ECM.

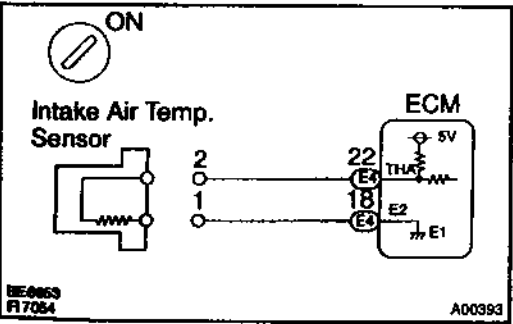

PREPARATION:

- (a) Disconnect the mass air flow meter connector.
- (b) Turn the ignition switch ON.

CHECK:

Read temperature value on the OBD II scan tool or TOYOTA hand-held tester.

OK:

Temperature value: -40°C (-40°F)

OK Replace mass air flow meter.

NG

5 Check for short in harness or ECM.

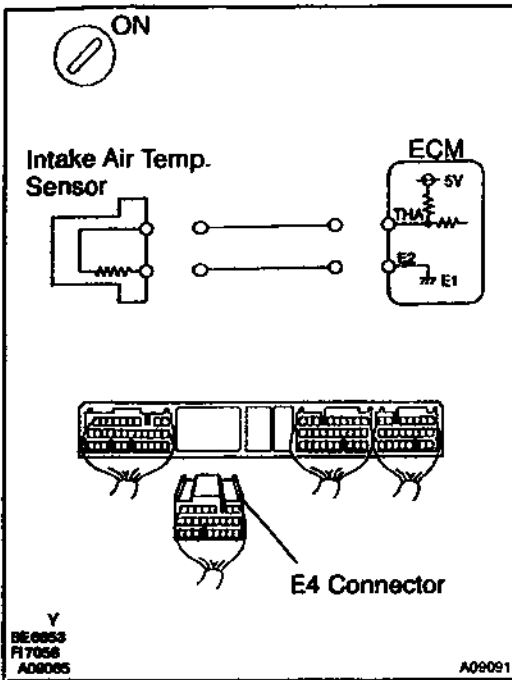
**PREPARATION:**

- Remove the ECM cover.
- Disconnect the E4 connector of the ECM.

HINT:

Intake air temp. sensor connector is disconnected.

- Turn the ignition switch ON.

CHECK:

Read temperature value on the OBD II scan tool or TOYOTA hand-held tester.

OK:

Temperature value: -40°C (-40°F)

OK

Repair or replace harness or connector.

NG

Check and replace ECM (See page IN-30).

DTC	P0115	Engine Coolant Temp. Circuit Malfunction
------------	--------------	-------------------------------------------------

CIRCUIT DESCRIPTION

A thermistor built into the engine coolant temp. sensor changes the resistance value according to the engine coolant temp.

The structure of the sensor and connection to the ECM is the same as in the intake air temp. circuit malfunction shown on page DI-28.

If the ECM detects the DTC P0115, it operates fail safe function in which the engine coolant temperature is assumed to be 80°C (176°F).

DTC No.	Detection Item	Trouble Area
P0115	Open or short in engine coolant temp. sensor circuit	<ul style="list-style-type: none"> • Open or short in engine coolant temp. sensor circuit • Engine coolant temp. sensor • ECM

HINT:

After confirming DTC P0115, use the OBD II scan tool or TOYOTA hand-held tester to confirm the engine coolant temp. from "CURRENT DATA".

Temp. Displayed	Malfunction
-40°C (-40°F)	Open circuit
140°C (284°F) or more	Short circuit

WIRING DIAGRAM

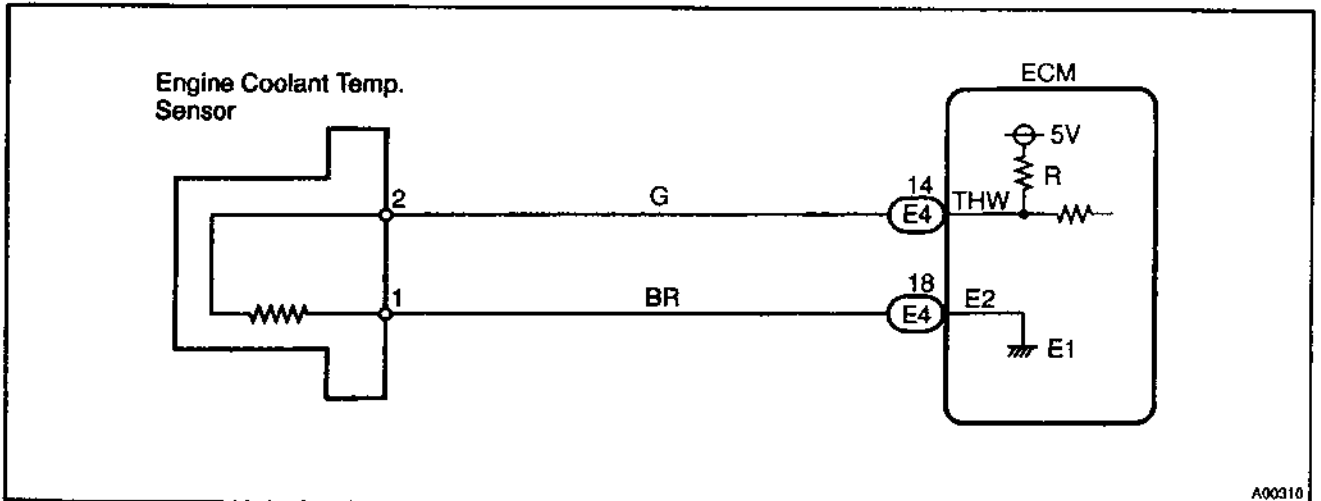

INSPECTION PROCEDURE

HINT:

- If DTC P0100 (Mass Air Flow Meter Circuit Malfunction), P0101 (Mass Air Flow Meter Circuit Range/Performance Problem), P0110 (Intake Air Temp. Circuit Malfunction), P0115 (Engine Coolant Temp. Circuit Malfunction), P0120 (Throttle/Pedal Position Sensor/Switch "A" Circuit Malfunction) are output simultaneously, E2 (sensor ground) may be open.
- Read freeze frame data using TOYOTA hand-held tester or OBD II scan tool. Because freeze frame records the engine conditions when the malfunction is detected, when troubleshooting it is useful for determining whether the vehicle was running or stopped, the engine warmed up or not, the air-fuel ratio lean or rich, etc. at the time of the malfunction.

- | | |
|----------|-----------------------------------------------------------------------------------------------------------|
| 1 | Connect OBD II scan tool or TOYOTA hand-held tester, and read value of engine coolant temperature. |
|----------|-----------------------------------------------------------------------------------------------------------|

PREPARATION:

- Connect the OBD II scan tool or TOYOTA hand-held tester to the DLC3.
- Turn the ignition switch ON and push the OBD II scan tool or TOYOTA hand-held tester main switch ON.

CHECK:

Read temperature value on the OBD II scan tool or TOYOTA hand-held tester.

OK:

Same as actual engine coolant temperature

HINT:

- If there is open circuit, OBD II scan tool or TOYOTA hand-held tester indicates -40°C (-40°F).
- If there is open circuit, OBD II scan tool or TOYOTA hand-held tester indicates 140°C (284°F) or more.

NG

-40°C (-40°F) ... Go to step 2.
 140°C (284°F) or more ... Go to step 4.

OK

**Check for Intermittent problems
 (See page DI-3).**

2 Check for open in harness or ECM.

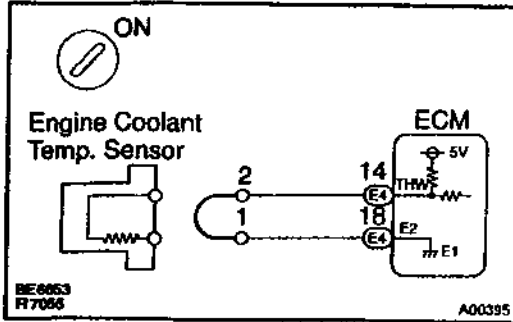

PREPARATION:

- (a) Disconnect the engine coolant temp. sensor connector.
- (b) Connect the sensor wire harness terminals together.
- (c) Turn the ignition switch ON.

CHECK:

Read temperature value on the OBD II scan tool or TOYOTA hand-held tester.

OK:

Temperature value: 140°C (284°F) or more

OK

Confirm good connection at sensor. If OK, replace engine coolant temp. sensor.

NG

3 Check for open in harness or ECM.

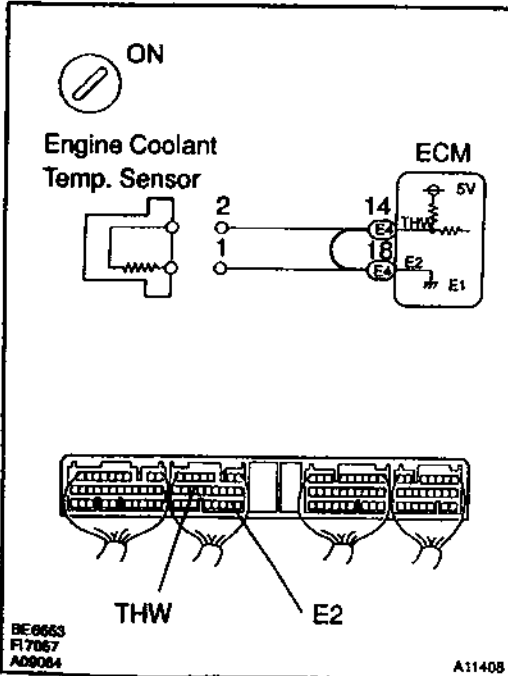

PREPARATION:

- (a) Remove the ECM cover.
- (b) Connect between terminals THW and E2 of the ECM connector.

HINT:

Engine coolant temp. sensor connector is disconnected. Before checking, do a visual and contact pressure check for the ECM connector (See page IN-30).

- (c) Turn the ignition switch ON.

CHECK:

Read temperature value on the OBD II scan tool or TOYOTA hand-held tester.

OK:

Temperature value: 140°C (284°F) or more

OK

Open in harness between terminals E2 or THW, repair or replace harness.

NG

Confirm good connection at ECM. If OK, check and replace ECM (See page IN-30).

4 Check for short in harness and ECM.

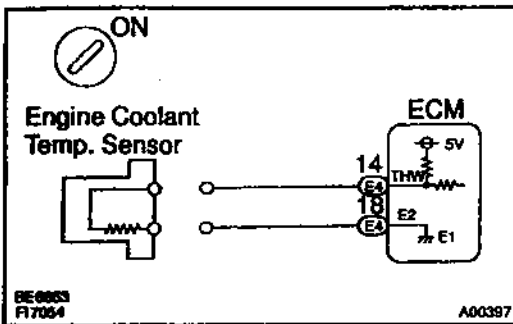

PREPARATION:

- (a) Disconnect the engine coolant temp. sensor connector.
- (b) Turn the ignition switch ON.

CHECK:

Read temperature value on the OBD II scan tool or TOYOTA hand-held tester.

OK:

Temperature value: -40°C (-40°F)

OK

Replace engine coolant temp. sensor.

NG

5 Check for short in harness or ECM.

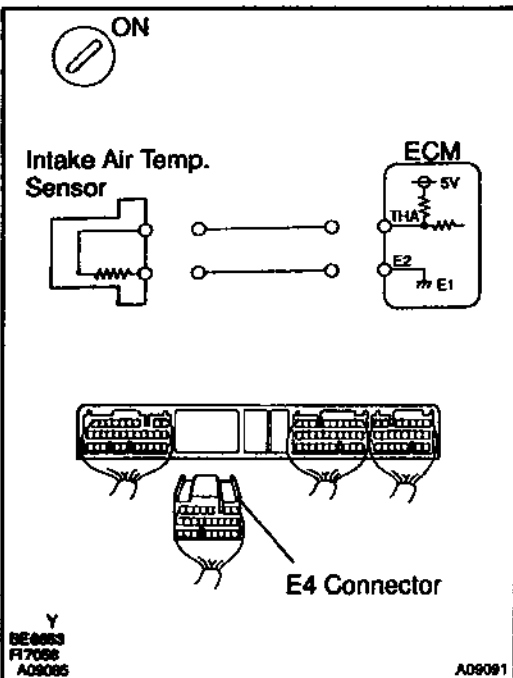

PREPARATION:

- (a) Remove the ECM cover.
- (b) Disconnect the E4 connector of the ECM.

HINT:

Engine coolant temp. sensor connector is disconnected.

- (c) Turn the ignition switch ON.

CHECK:

Read temperature value on the OBD II scan tool or TOYOTA hand-held tester.

OK:

Temperature value: -40°C (-40°F)

OK

Repair or replace harness or connector.

NG

Check and replace ECM (See page IN-30).

DTC	P0116	Engine Coolant Temp. Circuit Range/ Performance Problem
------------	--------------	--------------------------------------------------------------------

CIRCUIT DESCRIPTION

Refer to DTC P0115 (Engine Coolant Temp. Circuit Malfunction) on page DI-33.

DTC No.	DTC Detecting Condition	Trouble Area
P0116	When the engine starts, the water temp. is -7°C (20°F) or less. And, 20 min. or more after the engine starts, the engine temp. sensor value is 20°C (68°F) or less (2 trip detection logic)	<ul style="list-style-type: none"> • Engine coolant temp. sensor • Cooling system
	When the engine starts, the water temp. is between -7°C (20°F) and 10°C (50°F) And, 5 min. or more after the engine starts, the engine coolant temp. sensor value is 20°C (68°F) or less (2 trip detection logic)	

INSPECTION PROCEDURE

HINT:

- If DTC P0115 (Engine Coolant Temp. Circuit Malfunction) and P0116 (Engine Coolant Temp. Circuit Range/Performance Problem) are output simultaneously, engine coolant temp. sensor circuit may be open. Perform troubleshooting of DTC P0115 first.
- Read freeze frame data using TOYOTA hand-held tester or OBD II scan tool. Because freeze frame records the engine conditions when the malfunction is detected, when troubleshooting it is useful for determining whether the vehicle was running or stopped, the engine warmed up or not, the air-fuel ratio lean or rich, etc. at the time of the malfunction.

1	Are there any other codes (besides DTC P0116) being output?
----------	--------------------------------------------------------------------

YES

Go to relevant DTC chart.

NO

2	Check thermostat (See page CO-8).
----------	------------------------------------------

NG

Replace thermostat.

OK

Replace engine coolant temp. sensor.

DTC	P0120	Throttle Position Sensor/Switch "A" Circuit Malfunction
------------	--------------	--------------------------------------------------------------------

CIRCUIT DESCRIPTION

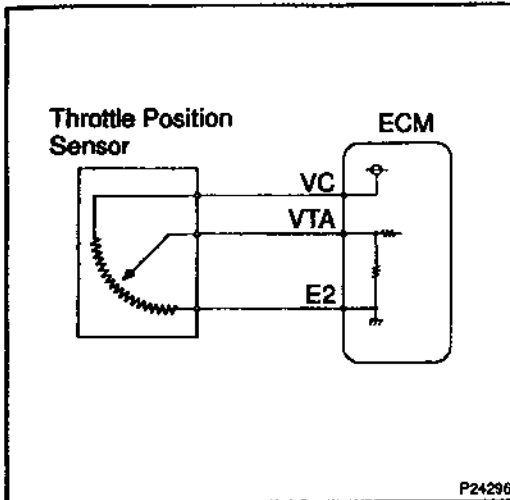

The throttle position sensor is mounted in the throttle body and detects the throttle valve opening angle. When the throttle valve is fully closed, a voltage of approximately 0.3 – 0.8 V is applied to terminal VTA of the ECM. The voltage applied to the terminals VTA of the ECM increases in proportion to the opening angle of the throttle valve and becomes approximately 3.2 – 4.9 V when the throttle valve is fully opened. The ECM judges the vehicle driving conditions from this signal input from terminal VTA, and uses it as one of the conditions for deciding the air-fuel ratio correction, power increase correction and fuel-cut control etc.

DTC No.	DTC Detecting Condition	Trouble Area
P0120	Condition (a) or (b) continues with more than 5 sec.: (a) VTA < 0.1 V (b) VTA > 4.9 V	<ul style="list-style-type: none"> • Open or short in throttle position sensor circuit • Throttle position sensor • ECM

HINT:

After confirming DTC P0120, use the OBD II scan tool or TOYOTA hand-held tester to confirm the throttle valve opening percentage.

Throttle valve opening position expressed as percentage		Trouble Area
Throttle valve fully closed	Throttle valve fully open	
0 %	0 %	VC line open VTA line open or short
Approx. 100 %	Approx. 100 %	E2 line open

WIRING DIAGRAM

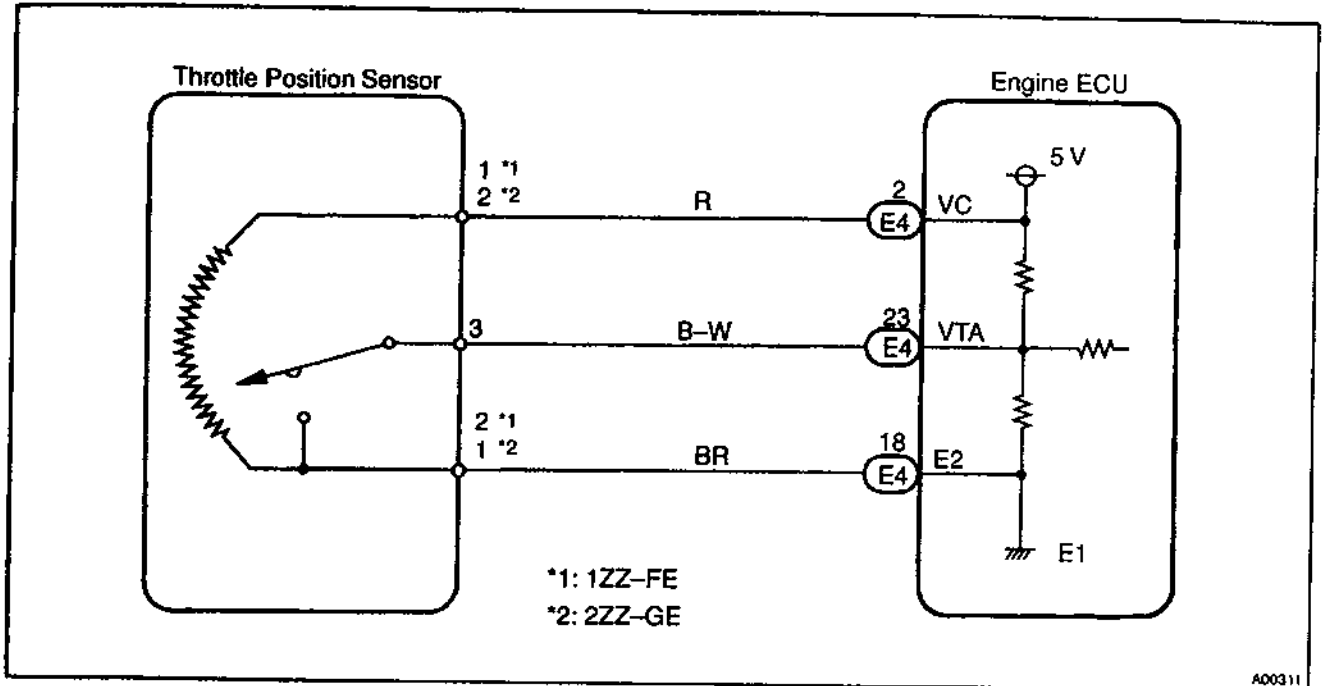

INSPECTION PROCEDURE

HINT:

- If DTC P0100 (Mass Air Flow Meter Circuit Malfunction), P0106 (Mass Air Flow Meter Circuit Range/Performance Problem), P0110 (Intake Air Temp. Circuit Malfunction), P0115 (Engine Coolant Temp. Circuit Malfunction), P0120 (Throttle/Pedal Position Sensor/Switch "A" Circuit Malfunction) are output simultaneously, E2 (sensor ground) may be open.
- Read freeze frame data using TOYOTA hand-held tester or OBD II scan tool. Because freeze frame records the engine conditions when the malfunction is detected, when troubleshooting it is useful for determining whether the vehicle was running or stopped, the engine warmed up or not, the air-fuel ratio lean or rich, etc. at the time of the malfunction.

1 Connect the OBD II scan tool or TOYOTA hand-held tester, read the throttle valve opening percentage.

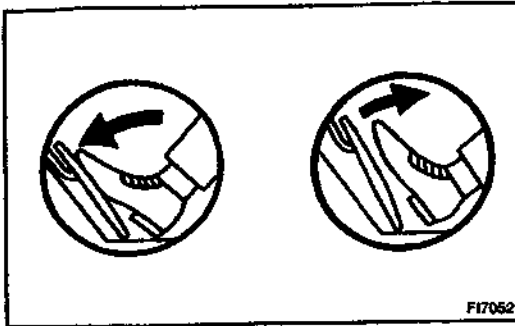

PREPARATION:

- (a) Connect the OBD II scan tool or TOYOTA hand-held tester to DLC3.
- (b) Turn the ignition switch ON and push the OBD II scan tool or TOYOTA hand-held tester main switch ON.

CHECK:

Read the throttle valve opening percentage.

OK:

Throttle valve	Throttle valve opening position expressed as percentage
Fully open	Approx. 70 %
Fully closed	Approx. 10 %

OK Check for intermittent problems (See page DI-3).

NG

2 Check voltage between terminal VC of throttle position sensor connector and body ground.

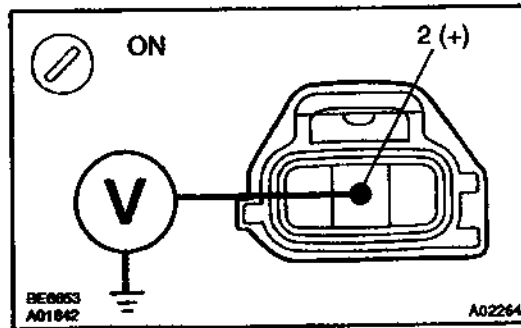

PREPARATION:

- (a) Disconnect the throttle position sensor connector.
- (b) Turn the ignition switch ON.

CHECK:

Measure voltage between terminal VC of the throttle position connector and body ground.

OK:

Voltage: 4.5 – 5.5 V

NG Go to step 5.

OK

3 Check throttle position sensor (See page SF-33).

NG Replace throttle position sensor.

OK

4 Check voltage between terminals VTA and E2 of ECM connector.

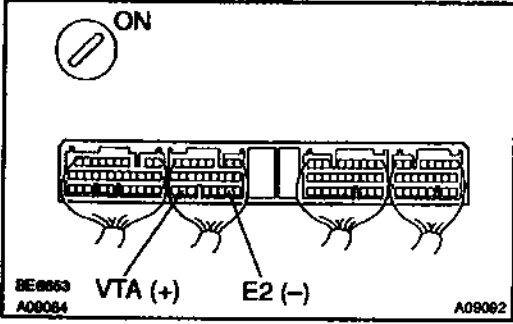

PREPARATION:

- (a) Remove the ECM cover.
- (b) Turn the ignition switch ON.

CHECK:

Measure voltage between terminals VTA and E2 of the ECM connector.

OK:

Throttle valve	Voltage
Fully closed	0.3 - 1.0 V
Fully open	3.2 - 4.9 V

NG Check for open and short in harness and connector between ECM and throttle position sensor (VTA or E2 line) (See page IN-30).

OK

Check and replace ECM (See page IN-30).

5 Check voltage between terminals VC and E2 of ECM connector.

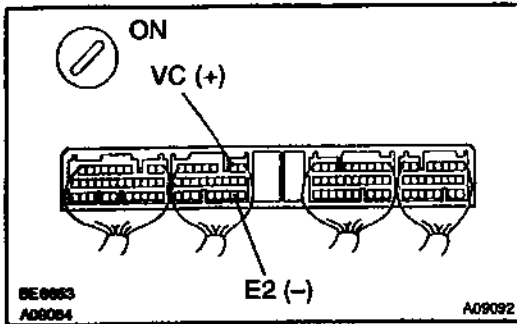

PREPARATION:

- (a) Remove the ECM cover.
- (b) Turn ignition switch ON.

CHECK:

Measure voltage between terminals VC and E2 of the ECM connector.

OK:

Voltage: 4.5 – 5.5 V

NG

Check and replace ECM (See page IN-30).

OK

Check for open in harness and connector between ECM and sensor (VC line) (See page IN-30).

DTC	P0121	Throttle/Pedal Position Sensor/Switch "A" Circuit Range/Performance Problem
------------	--------------	----------------------------------------------------------------------------------------

CIRCUIT DESCRIPTION

Refer to DTC P0120 (Throttle/Pedal Position Sensor/Switch "A" Circuit Malfunction) on page DI-38.

DTC No.	Detection Item	Trouble Area
P0121	After the vehicle speed has been exceeded 30 km/h (19 mph) even once, the output value of the throttle position sensor is out of the applicable range while the vehicle speed between 30 km/h (19 mph) and 0 km/h (0 mph). (2 trip detection logic)	<ul style="list-style-type: none"> • Throttle position sensor • ECM

INSPECTION PROCEDURE

HINT:

Read freeze frame data using TOYOTA hand-held tester or OBD II scan tool. Because freeze frame records the engine conditions when the malfunction is detected, when troubleshooting it is useful for determining whether the vehicle was running or stopped, the engine warmed up or not, the air-fuel ratio lean or rich, etc. at the time of the malfunction.

1	Are there any other codes (besides DTC P0121) being output?
----------	--------------------------------------------------------------------

YES

Go to relevant DTC chart.

NO

Replace throttle position sensor.

DTC**P0125****Insufficient Temp. for Closed Loop
Fuel Control****CIRCUIT DESCRIPTION**

To obtain a high purification rate for the CO, HC and NO_x components of the exhaust gas, a three-way catalytic converter is used, but for the most efficient use of the three-way catalytic converter, the air-fuel ratio must be precisely controlled so that it is always close to the stoichiometric air-fuel ratio.

The oxygen sensor has the characteristic whereby its output voltage changes suddenly in the vicinity of the stoichiometric air-fuel ratio. This is used to detect the oxygen concentration in the exhaust gas and provide feedback to the computer for control of the air-fuel ratio.

When the air-fuel ratio becomes LEAN, the oxygen concentration in the exhaust increases and the oxygen sensor informs the ECM of the LEAN condition (small electromotive force: < 0.45 V).

When the air-fuel ratio is RICHER than the stoichiometric air-fuel ratio the oxygen concentration in the exhaust gas is reduced and the oxygen sensor informs the ECM of the RICH condition (large electromotive force: > 0.45V).

The ECM judges by the electromotive force from the oxygen sensor whether the air-fuel ratio is RICH or LEAN and controls the injection time accordingly. However, if malfunction of the oxygen sensor causes output of abnormal electromotive force, the ECM is unable to perform accurate air-fuel ratio control.

The oxygen sensors include a heater which heats the zirconia element. The heater is controlled by the ECM. When the intake air volume is low (the temp. of the exhaust gas is low) current flows to the heater to heat the sensor for accurate oxygen concentration detection.

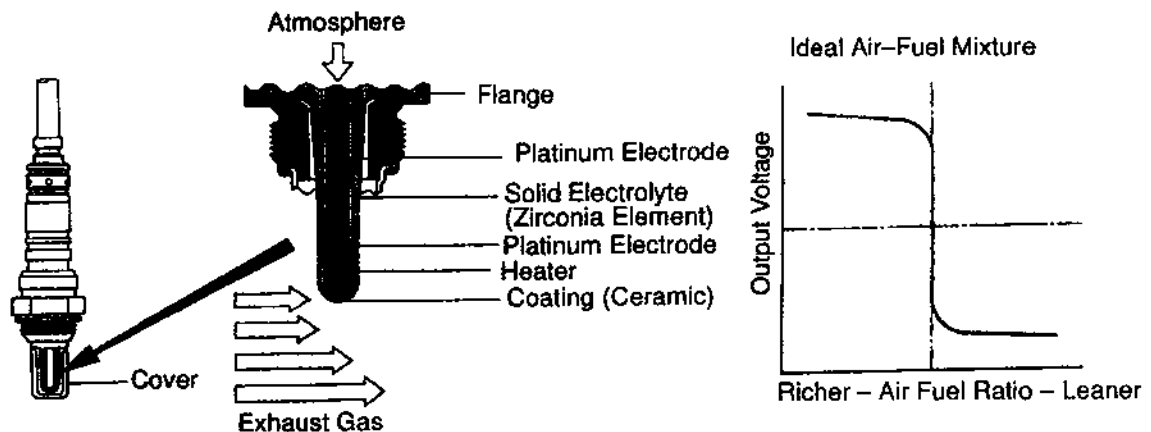

P21242 F17210

A04485

DTC No.	DTC Detecting Condition	Trouble Area
P0125	<p>After the engine is warmed up, oxygen sensor (bank 1 sensor 1) output does not indicate RICH (≥ 0.45 V) even once when conditions (a), (b), and (c) continue for at least 1.5 min.</p> <p>(a) Engine speed: 1,500 rpm or more (b) Vehicle speed: 40 - 100 km/h (25 - 62 mph) (c) Throttle valve does not fully closed</p>	<ul style="list-style-type: none"> • Fuel system • Air induction system • Injector • Ignition system • Gas leakage on exhaust system • Open or short in heated oxygen sensor (bank 1 sensor 1) circuit • Heated oxygen sensor (bank 1 sensor 1) • ECM

HINT:

After confirming DTC P0125, use the OBD II scan tool or TOYOTA hand-held tester to confirm voltage output of oxygen sensor (bank 1 sensor 1) from "CURRENT DATA".

If voltage output of oxygen sensor (bank 1 sensor 1) is less than 0.1 V, oxygen sensor (bank 1 sensor 1) circuit may be open or short.

WIRING DIAGRAM

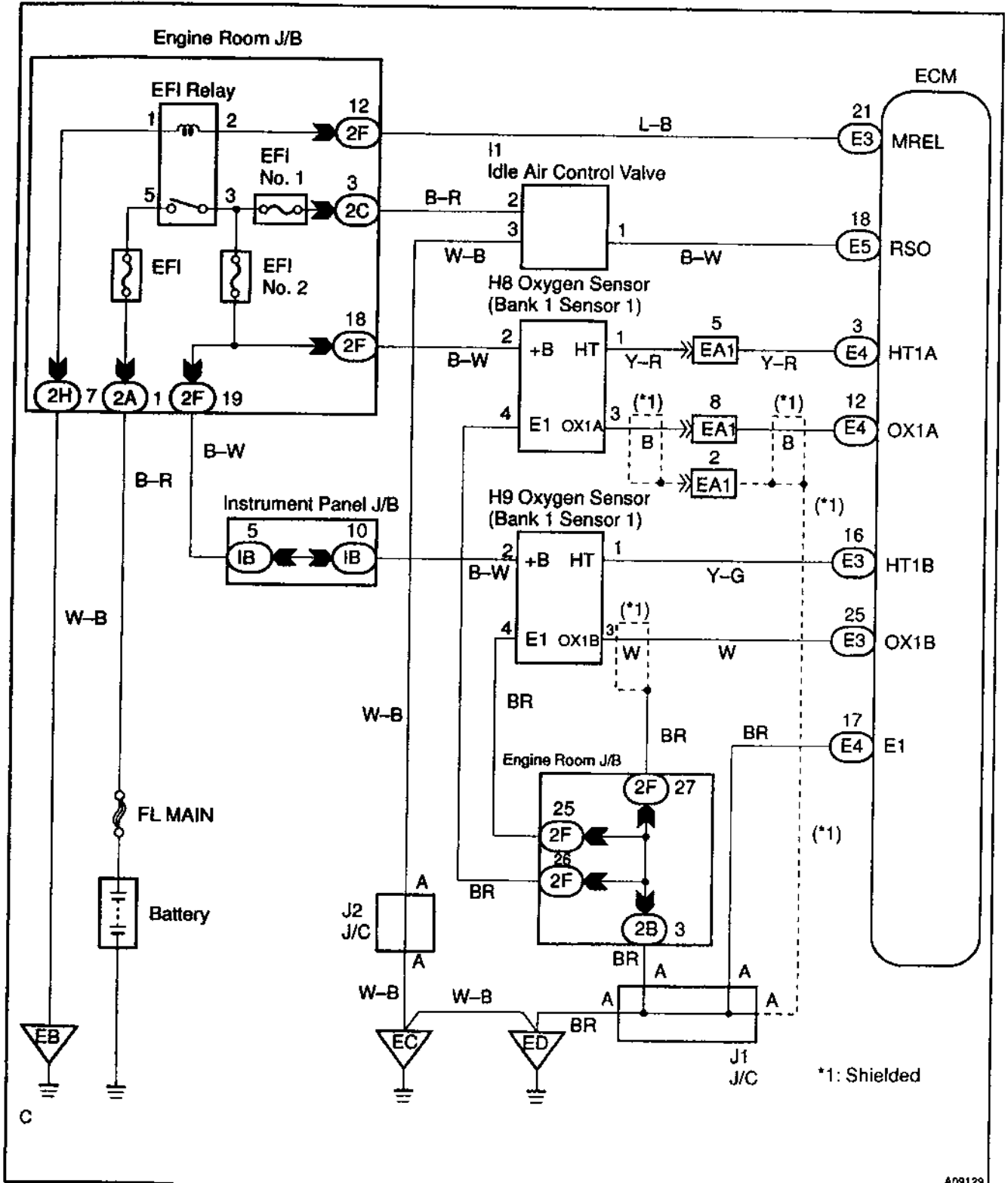

INSPECTION PROCEDURE

HINT:

- If the vehicle run out of fuel, the air-fuel ratio is LEAN and DTC P0125 will be recorded .
The MIL then comes on.
- Read freeze frame data using TOYOTA hand-held tester or OBD II scan tool. Because freeze frame records the engine conditions when the malfunction is detected, when troubleshooting it is useful for determining whether the vehicle was running or stopped, the engine warmed up or not, the air-fuel ratio lean or rich, etc at the time of the malfunction.

1 Are there any other codes (besides DTC P0125) being output ?

YES

Go to relevant DTC chart.

NO

2 Connect the OBD II scan tool or TOYOTA hand-held tester and read value for voltage output of oxygen sensor (bank 1 sensor 1).

PREPARATION:

- Connect the OBD II scan tool or TOYOTA hand-held tester to the DLC3.
- Warm up engine to normal operating temp (above 75°C).

CHECK:

Read voltage output of the oxygen sensor (bank 1 sensor 1) when engine is suddenly raced.

HINT:

Perform quick racing to 4,000 rpm 3 times using accelerator pedal.

OK:

Both oxygen sensor (bank 1 sensor 1) output a RICH signal (0.45 V or more) at least once.

OK

Go to step 10.

NG

3 Check for open and short in harness and connector between ECM and oxygen sensor (bank 1 sensor 1) (See page IN-30).

NG

Repair or replace harness or connector.

OK

4 Check whether misfire is occurred or not by monitoring DTC and data list.

NG

Perform troubleshooting for misfire (See page DI-64).

OK

5 Check air induction system (See page SF-1).

NG

Repair or replace induction system.

OK

6 Check fuel pressure (See page SF-6).

NG

Check and repair fuel pump, fuel pipe line and filter (See page SF-1).

OK

7 Check injector Injection (See page SF-22).

NG

Replace injector.

OK

8 Check gas leakade on exhaust system.

NG Repair or replace.

OK

Replace oxygen sensor (bank 1 sensor 1).

9 Perform confirmation driving pattern (See page DI-49).

Go

10 Is there DTC P0125 being output again?

YES Check and replace ECM.

NO

11 Did vehicle runs out of fuel in the past?

NO Check for intermittent problems.

YES

DTC P0125 is caused by running out of fuel.

DTC	P0130	Oxygen Sensor Circuit Malfunction (Bank 1 Sensor 1)
------------	--------------	----------------------------------------------------------------

CIRCUIT DESCRIPTION

Refer to DTC P0125 (Insufficient Coolant Temp. for Closed Loop Fuel Control) on page DI-44.

DTC No.	DTC Detecting Condition	Trouble Area
P0130	Voltage output of oxygen sensor remains at 0.4 V or more, or 0.55 V or less, during idling after the engine is warmed up (2 trip detection logic)	<ul style="list-style-type: none"> • Open or short in heated oxygen sensor circuit • Heated oxygen sensor • Air induction system • EGR system • Fuel pressure • Injector • ECM

HINT:

Sensor 1 refers to the sensor closer to the engine body.

The oxygen sensor's output voltage and the short-term fuel trim value can be read using the OBD II scan tool or TOYOTA hand-held tester.

WIRING DIAGRAM

Refer to DTC P0125 (Insufficient Coolant Temp. for Closed Loop Fuel Control) on page DI-44 for the WIRING DIAGRAM.

CONFIRMATION DRIVING PATTERN

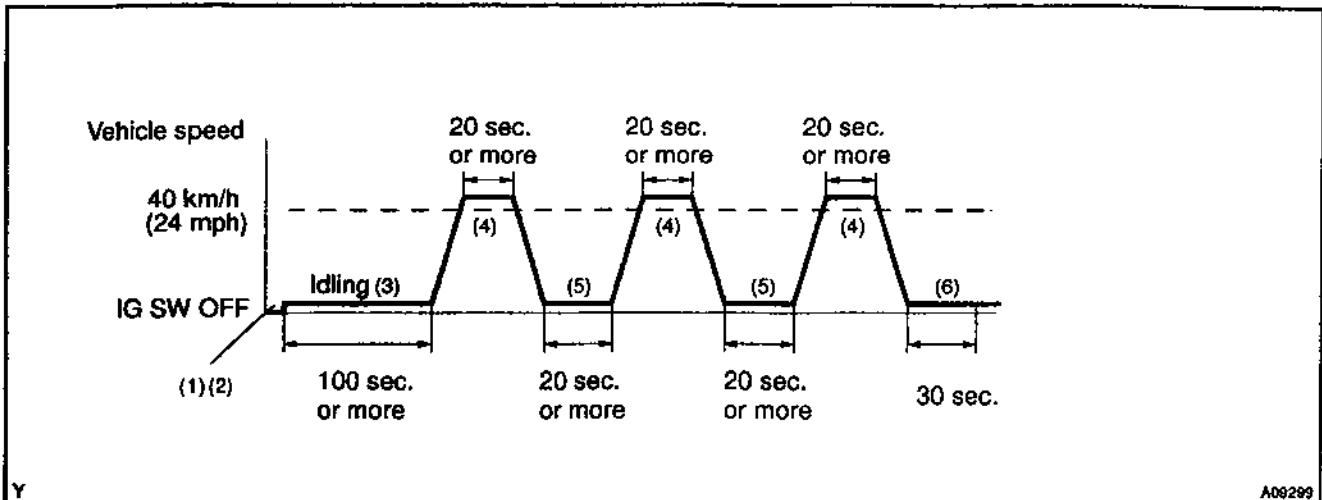

- (1) Connect the TOYOTA hand-held tester to the DLC3.
- (2) Switch the TOYOTA hand-held tester from normal mode to check mode (See page DI-3).
- (3) Start the engine and let the engine idle for 100 sec. or more.
- (4) Drive the vehicle at 40 km/h (24 mph) or more for 20 sec. or more.
- (5) Let the engine idle for 20 sec. or more.
- (6) Let the engine idle for 30 sec.

HINT:

If a malfunction exists, the MIL will light up during step (6).

NOTICE:

If the conditions in this test are not strictly followed, detection of the malfunction will not be possible. If you do not have a TOYOTA hand-held tester, turn the ignition switch OFF after performing steps (3) to (6), then perform steps (3) to (6) again.

INSPECTION PROCEDURE

HINT:

Read freeze frame data using TOYOTA hand-held tester or OBD II scan tool. Because freeze frame records the engine conditions when the malfunction is detected, when troubleshooting it is useful for determining whether the vehicle was running or stopped, the engine warmed up or not, the air-fuel ratio lean or rich, etc. at the time of the malfunction.

1

Are there any other codes (besides DTC P0130) being output?

YES

Go to relevant DTC chart.

NO

2 Check the output voltage of oxygen sensor during idling.

PREPARATION:

Warm up the oxygen sensor the engine at 2,500 rpm for approx. 90 sec.

CHECK:

Use the OBD II scan tool or TOYOTA hand-held tester read the output voltage of the oxygen sensor during idling.

OK:

Oxygen sensor output voltage:

Alternates repeatedly between less than 0.4 V and more than 0.55 V (See the Following table).

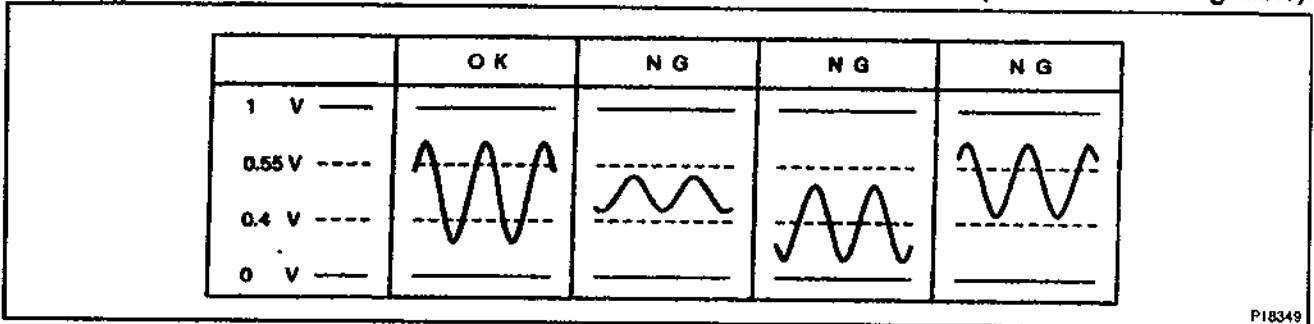

OK Perform confirmation driving pattern (See page DI-49).

NG

3 Check for open and short in harness and connector between ECM and oxygen sensor (bank 1 sensor 1) (See page IN-20).

NG Repair or replace harness or connector.

OK

4 Check air induction system (See page SF-1).

NG Repair or replace induction system.

OK

5 Check fuel pressure (See page SF-6).

NG Check and repair fuel pump, fuel pipe line and filter (See page SF-1).

OK

6 Check Injector Injection (See page SF-22).

NG Replace Injector.

OK

Replace oxygen sensor (bank 1 sensor 1).

7 Perform confirmation driving pattern (See page DI-49).

Go

8 Are there DTC P0130 being output again?

YES Check for Intermittent problems (See page DI-3).

NO

Check and replace ECM.

DTC	P0133	Oxygen Sensor Circuit Slow Response (Bank 1 Sensor 1)
------------	--------------	--------------------------------------------------------------

CIRCUIT DESCRIPTION

Refer to DTC P0125 (Insufficient Coolant Temp. for Closed Loop Fuel Control) on page DI-44.

DTC No.	DTC Detecting Condition	Trouble Area
P0133	Response time for the oxygen sensor's voltage output to change from rich to lean, or from lean to rich, is 1 sec. or more during idling after the engine is warmed up (2 trip detection logic)	<ul style="list-style-type: none"> • Open or short in heated oxygen sensor circuit • Heated oxygen sensor • Air induction system • EGR system • Fuel pressure • Injector • ECM

HINT:

Sensor 1 refers to the sensor closer to the engine body.

INSPECTION PROCEDURE

HINT:

Read freeze frame data using TOYOTA hand-held tester or OBD II scantool. Because freeze frame records the engine conditions when the malfunction is detected, when troubleshooting it is useful for determining whether the vehicle was running or stopped, the engine warmed up or not, the air-fuel ratio lean or rich, etc. at the time of the malfunction.

1	Are there any other codes (besides DTC P0133) being output?
----------	--------------------------------------------------------------------

YES

Go to relevant DTC chart.

NO

2 Check the output voltage of oxygen sensor during idling.

PREPARATION:

Warm up the oxygen sensor the engine at 2,500 rpm for approx. 90 sec.

CHECK:

Use the OBD II scan tool or TOYOTA hand-held tester read the output voltage of the oxygen sensor during idling.

OK:

Oxygen sensor output voltage:

Alternates repeatedly between less than 0.4 V and more than 0.55 V (See the Following table).

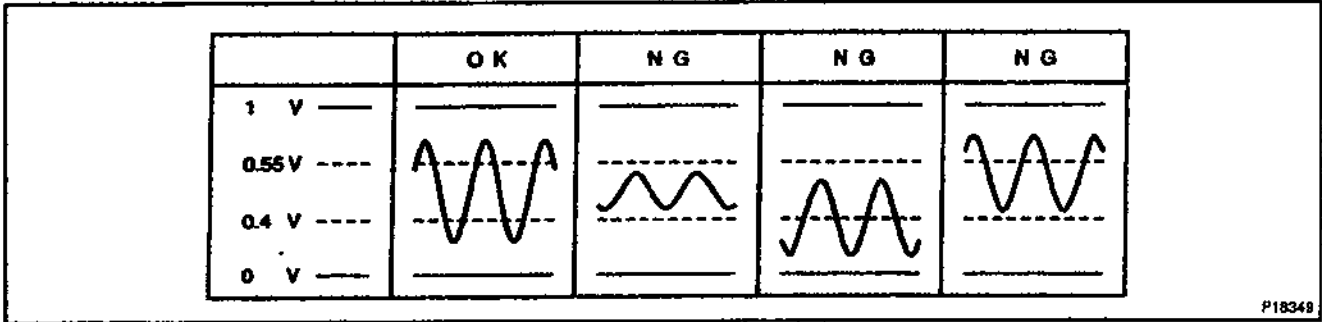

OK Perform confirmation driving pattern (See page DI-49).

NG

3 Check for open and short in harness and connector between ECM and oxygen sensor (bank 1 sensor 1) (See page IN-20).

NG Repair or replace harness or connector.

OK

4 Check air induction system (See page SF-1).

NG Repair or replace induction system.

OK

5 Check fuel pressure (See page SF-6).

NG Check and repair fuel pump, fuel pipe line and filter (See page SF-1).

OK

6 Check injector injection (See page SF-22).

NG Replace injector.

OK

Replace oxygen sensor (bank 1 sensor 1).

7 Perform confirmation driving pattern (See page DI-49).

Go

8 Are there DTC P0133 being output again?

YES Check for intermittent problems (See page DI-3).

NO

Check and replace ECM.

DTC	P0135	Heated Oxygen Sensor Heater Circuit Malfunction (Bank1 Sensor1)
------------	--------------	------------------------------------------------------------------------

DTC	P0141	Heated Oxygen Sensor Heated Circuit Malfunction (Bank1 Sensor2)
------------	--------------	------------------------------------------------------------------------

CIRCUIT DESCRIPTION

Refer to DTC P0125 (Insufficient Coolant Temp. for Closed Loop Fuel Control) on page DI-44.

DTC No.	DTC Detecting Condition	Trouble Area
P0135	When the heater operates, heater current exceeds 2 A (2 trip detection logic)	<ul style="list-style-type: none"> • Open or short in heater circuit of heated oxygen sensor • Heated oxygen sensor heater • ECM
P0141	Heater current of 0.2 A or less when the heater operates (2 trip detection logic)	

HINT:

- Bank 1 refers to the bank that includes cylinder No.1.
- Sensor 1 refers to the sensor closer to the engine body.
- Sensor 2 refers to the sensor farther away from the engine body.

WIRING DIAGRAM

Refer to DTC P0125 on page DI-44 for the WIRING DIAGRAM.

INSPECTION PROCEDURE

HINT:

Read freeze frame data using TOYOTA hand-held tester or OBD II scan tool. Because freeze frame records the engine conditions when the malfunction is detected, when troubleshooting it is useful for determining whether the vehicle was running or stopped, the engine warmed up or not, the air-fuel ratio lean or rich, etc. at the time of the malfunction.

- 1** Check voltage between terminals HT1, HT2 of ECM connectors and body ground.

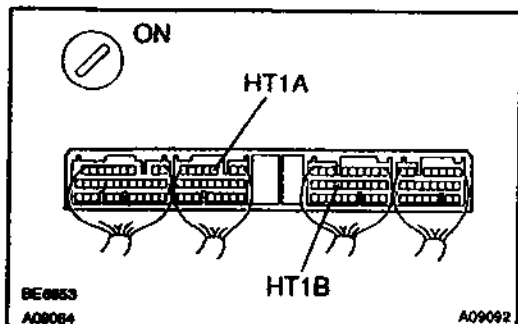
**PREPARATION:**

- Remove the ECM cover.
- Remove the 3 bolts from ECM.
- Turn the ignition switch ON.

CHECK:

Measure voltage between terminals HT1A, HT1B of ECM connectors and body ground.

HINT:

- Connect terminal HT1A to bank 1 sensor 1.
- Connect terminal HT1B to bank 1 sensor 2.

OK:

Voltage: 9 – 14 V

OK

Check and replace ECM (See page IN-30).

NG

- 2** Check resistance of heated oxygen sensor heater (See page SF-70).

NG

Replace heated oxygen sensor.

OK

Check and repair harness or connector between EFI main relay (Marking: EFI), heated oxygen sensor and ECM (See page IN-30).

DTC	P0136	Oxygen Sensor Circuit Malfunction (Bank 1 Sensor 2)
------------	--------------	----------------------------------------------------------------

CIRCUIT DESCRIPTION

Refer to DTC P0125 (Insufficient Coolant Temp. for Closed Loop Fuel Control) on page DI-44.

DTC No.	DTC Detecting Condition	Trouble Area
P0136	Voltage output of the heated oxygen sensor remains at 0.40 V or more, or 0.50 V or less when the vehicle is driven at 40 km/h (25 mph) or more after the engine is warmed up. (2 trip detection logic).	<ul style="list-style-type: none"> • Open or short in heated oxygen sensor circuit • Heated oxygen sensor

HINT:

Sensor 2 refers to the sensor farther away from the engine body.

WIRING DIAGRAM

Refer to DTC P0125 (Insufficient Coolant Temp. for Closed Loop Fuel Control) on page DI-44 for the WIRING DIAGRAM.

CONFIRMATION DRIVING PATTERN

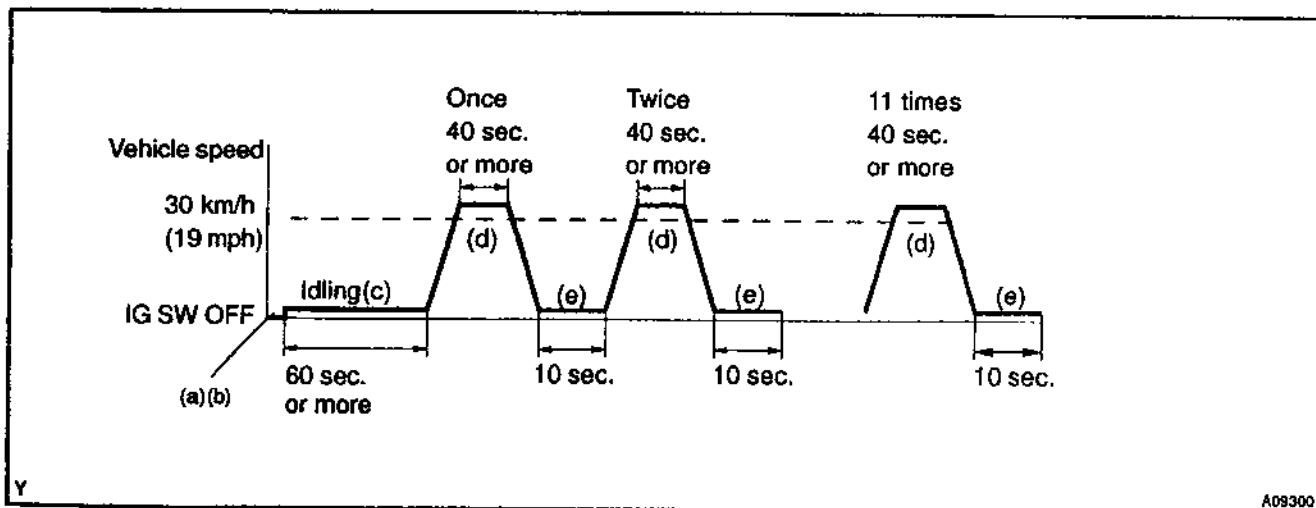

- Connect the hand-held tester to the DLC3.
- Switch the hand-held tester from the Normal Mode to the Check (Test) Mode (See page DI-3).
- Start the engine and let the engine idle for 60 seconds or more.
- Drive the vehicle at 30 km/h (18 mph) or more for 40 seconds or more.
- Let the engine idle for 10 seconds or more.
- Perform steps (d) to (e) 9 times.

HINT:

If a malfunction exists, the CHK ENG (MIL) will be indicated on the multi information display during step (f).

NOTICE:

If the conditions in this test are not strictly followed, detection of the malfunction will not be possible. If you do not have a hand-held tester, turn the ignition switch OFF after performing steps (c) to (f), then perform steps (c) to (f) again.

INSPECTION PROCEDURE

HINT:

Read freeze frame data using TOYOTA hand-held tester or OBD II scan tool. Because freeze frame records the engine conditions when the malfunction is detected, when troubleshooting it is useful for determining whether the vehicle was running or stopped, the engine warmed up or not, the air-fuel ratio lean or rich, etc. at the time of the malfunction.

1 Are there any other codes (besides DTC P0136) being output?

YES

Go to relevant DTC chart.

NO

2 Check for open and short in harness and connector between ECM and oxygen sensor (See page IN-30).

NG

Repair or replace harness or connector.

OK

3 Check output voltage of oxygen sensor.

PREPARATION:

- (a) Connect the OBD II scan tool or TOYOTA hand-held tester to the DLC3.
- (b) Warm up the engine to normal operating temp.

CHECK:

Read voltage output of oxygen sensor when engine suddenly raced.

HINT:

Perform quick racing to 4,000 rpm 3 min. using accelerator pedal.

OK:

Oxygen sensor output voltage: Alternates from 0.40 V or less to 0.50 V or more.

OK

Check that each connector is properly connected.

NG

Replace oxygen sensor.

DTC	P0171	System too Lean (Fuel Trim)
------------	--------------	------------------------------------

DTC	P0172	System too Rich (Fuel Trim)
------------	--------------	------------------------------------

CIRCUIT DESCRIPTION

Fuel trim refers to the feedback compensation value compared against the basic injection time. Fuel trim includes short-term fuel trim and long-term fuel trim.

Short-term fuel trim is the short-term fuel compensation used to maintain the air-fuel ratio at its ideal theoretical value. The signal from the oxygen sensor indicates whether the air-fuel ratio is RICH or LEAN compared to the ideal theoretical value, triggering a reduction in fuel volume if the air-fuel ratio is rich, and an increase in fuel volume if it is lean.

Long-term fuel trim is overall fuel compensation carried out long-term to compensate for continual deviation of the short-term fuel trim from the central value due to individual engine differences, wear over time and changes in the usage environment.

If both the short-term fuel trim and long-term fuel trim are LEAN or RICH beyond a certain value, it is detected as a malfunction and the MIL lights up.

DTC No.	DTC Detecting Condition	Trouble Area
P0171	When the air-fuel ratio feedback is stable after engine warming up, the fuel trim is considerably in error on the RICH side (2 trip detection logic)	<ul style="list-style-type: none"> • Air Induction system • Injector blockage • Mass air flow meter • Engine coolant temp. sensor • Fuel pressure • Gas leakage on exhaust system • Open or short in A/F sensor (bank 1 sensor 1) circuit • A/F sensor (bank 1 sensor 1)
P0172	When the air-fuel ratio feedback is stable after engine warming up, the fuel trim is considerably in error on the LEAN side. (2 trip detection logic)	<ul style="list-style-type: none"> • Injector leak, blockage • Mass air flow meter • Engine coolant temp. sensor • Ignition system • Fuel pressure • Gas leakage on exhaust system • Open or short in heated oxygen sensor (bank 1 sensor 1) circuit • Heated oxygen sensor (bank 1 sensor 1)

HINT:

- When the DTC P0171 is recorded, the actual air-fuel ratio is on the LEAN side. When DTC P0172 is recorded, the actual air-fuel ratio is on the RICH side.
- If the vehicle runs out of fuel, the air-fuel ratio is LEAN and DTC P0171 is recorded. The MIL then comes on.
- If the total of the short-term fuel trim value and long-term fuel trim value is within $\pm 38\%$, the system is functioning normally.
- The oxygen sensor output voltage and the short-term fuel trim value can be read using the OBD II scan tool or TOYOTA hand-held tester.

INSPECTION PROCEDURE**HINT:**

Read freeze frame data using TOYOTA hand-held tester or OBD II scan tool. Because freeze frame records the engine conditions when the malfunction is detected, when troubleshooting it is useful for determining whether the vehicle was running or stopped, the engine warmed up or not, the air-fuel ratio lean or rich, etc. at the time of the malfunction.

1 Check air induction system (See page SF-1).

NG

Repair or replace.

OK

2 Check injector injection (See page SF-22).

NG

Replace injector.

OK

3 Check mass air flow meter and engine coolant temp. sensor
(See page SF-63, SF-31).

NG

Repair or replace.

OK

4 Check for spark and ignition (See page IG-1).

NG

Repair or replace.

OK

5 Check fuel pressure (See page SF-6).

NG Check and repair fuel pump, pressure regulator, fuel pipe line and filter.

OK

6 Check gas leakade on exhaust system.

NG Repair or replace.

OK

7 Check the output voltage of oxygen sensor during idling.

PREPARATION:

Warm up the oxygen sensor the engine at 2,500 rpm for approx. 90 sec.

CHECK:

Use the OBD II scan tool or TOYOTA hand-held tester read the output voltage of the oxygen sensor during idling.

OK:

Oxygen sensor output voltage:

Alternates repeatedly between less than 0.4 V and more than 0.55 V (See the following table).

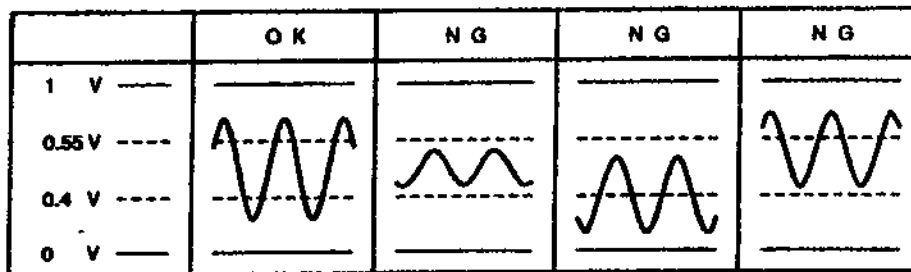

P18349

OK Go to step 9.

NG

8 Check for open and short in harness and connector between ECM and oxygen sensor (See page IN-20).

NG Repair or replace harness or connector.

OK

Replace oxygen sensor.

9 Perform confirmation driving pattern (See page DI-49).

GO

10 Is there DTC P0171 or P0172 being output again?

YES Check and replace ECM.

NO

11 Did vehicle runs out of fuel in the past?

NO Check for Intermittent problems.

YES

DTC P0171 or P0172 is caused by running out of fuel.

DTC	P0300	Random/Multiple Cylinder Misfire Detected
------------	--------------	--------------------------------------------------

DTC	P0301	Cylinder 1 Misfire Detected
------------	--------------	------------------------------------

DTC	P0302	Cylinder 2 Misfire Detected
------------	--------------	------------------------------------

DTC	P0303	Cylinder 3 Misfire Detected
------------	--------------	------------------------------------

DTC	P0304	Cylinder 4 Misfire Detected
------------	--------------	------------------------------------

CIRCUIT DESCRIPTION

Misfire: The ECM uses the crankshaft position sensor and camshaft position sensor to monitor changes in the crankshaft rotation for each cylinder.

The ECM counts the number of times the engine speed change rate indicates that misfire has occurred. And when the misfire rate equals or exceeds the count indicating that the engine condition has deteriorated, the MIL lights up.

If the misfire rate is high enough and the driving conditions will cause catalyst overheating, the MIL blinks when misfiring occurs.

DTC No.	DTC Detecting Condition	Trouble Area
P0300 P0301 P0302 P0303 P0304	Misfiring of random cylinders is detected during any particular 200 or 1,000 revolutions For any particular 200 revolutions for the engine, misfiring is detected which can cause catalyst overheating (This causes MIL to blink)	<ul style="list-style-type: none"> • Open or short in engine wire • Connector connection • Vacuum hose connection • Ignition system • Injector • Fuel pressure • Manifold absolute pressure sensor • Engine coolant temp. sensor • Compression pressure • Valve clearance • Valve timing • VVTL system (Locker arm) • ECM

HINT:

When the 2 or more codes for a misfiring cylinder are recorded repeatedly but no random misfire code is recorded, it indicates that the misfires were detected and recorded at different times.

WIRING DIAGRAM

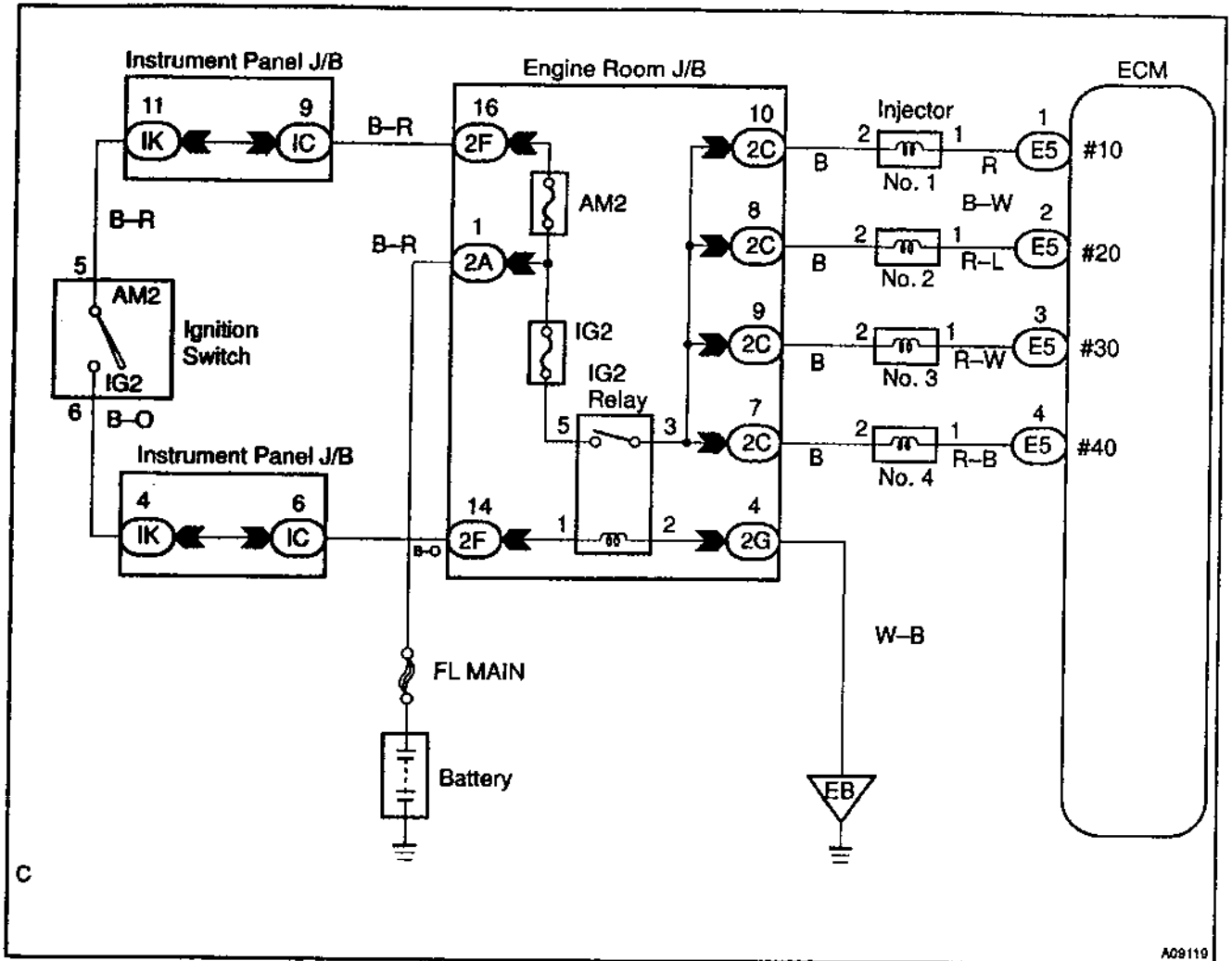

C

CONFIRMATION DRIVING PATTERN

- (a) Connect the TOYOTA hand-held tester or OBD II scan tool.
- (b) Record DTC and the freeze frame data.
- (c) Use the TOYOTA hand-held tester to set to Check Mode (See page DI-3).
- (d) Drive the vehicle several times with the engine speed, load and its surrounding range shown with ENGINE SPD, CALC LOAD in the freeze frame data or MISFIRE RPM, MISFIRE LOAD in the data list. If you have no TOYOTA hand-held tester, turn the ignition switch OFF after the symptom is simulated the first time. Then repeat the simulation process again.

HINT:

In order to memorize DTC of misfire, it is necessary to drive around MISFIRE RPM, MISFIRE LOAD in the data list for the following period of time.

Engine Speed	Time
Idling	3 minutes 30 seconds or more
1000 rpm	3 minutes or more
2000 rpm	1 minute 30 seconds or more
3000 rpm	1 minute or more

- (e) Check whether there is misfire or not by monitoring DTC and the freeze frame data. After that, record them.
- (f) Turn ignition switch OFF and wait at least 5 seconds.

INSPECTION PROCEDURE

HINT:

- If is the case that DTC besides misfire is memorized simultaneously, first perform the troubleshooting for them.
- Read freeze frame data using TOYOTA hand-held tester or OBD II scan tool. Because freeze frame data records the engine conditions when the malfunction is detected, when troubleshooting it is useful for determining whether the vehicle was running or stopped, the engine warmed up or not, the air-fuel ratio lean or rich, etc. at the time of the malfunction.
- When the vehicle is brought to the workshop and the misfire is not occurred, misfire can be confirmed by reproducing the condition or freeze frame data. Also, after finishing the repair, confirm that there is no misfire. (See the confirmation driving pattern)
- When either of SHORT FT #1, LONG FT #1, SHORT FT #2 or LONG FT #2 in the freeze frame data is besides the range of $\pm 20\%$, there is a possibility that the air-fuel ratio is inclining either to "rich" (-20% or less) or "lean" ($+20\%$ or more).
- When COOLANT TEMP in the freeze frame data is less than 80°C (176°F), there is a possibility or misfire only during warming up.
- In the case that misfire cannot be reproduced, the reason may be because of the driving with lack or fuel, the use of improper fuel, a stain of ignition plug, and etc.

1

Check wire harness, connector and vacuum hose in engine room.

CHECK:

- Check the connection conditions of wire harness and connector.
- Check the disconnection, piping and break of vacuum hose.

NG

Repair or replace, then confirm that there is no misfire (See the confirmation driving pattern).

OK

2

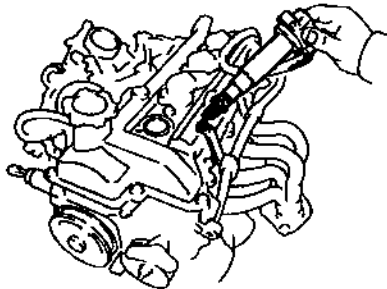
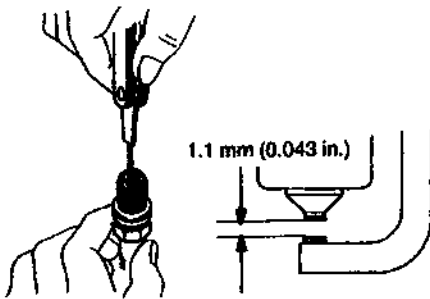
Check spark plug and spark of misfiring cylinder.

N

IG0317
IG0151
A09027

A09093

PREPARATION:

- Disconnect the high-tension cord.
- Remove the spark plug.

CHECK:

- Check for carbon deposits on electrode.
- Check electrode gap.

OK:

- No large carbon deposit present.
Not wet with gasoline or oil.
- Electrode gap: 1.1 mm (0.043 in.)

PREPARATION:

- Install the spark plug to the high-tension code.
- Disconnect the injector connector.
- Ground spark plug.

CHECK:

Check if spark occurs while engine is being cranked.

NOTICE:

To prevent excess fuel being injected from the injectors during this test, do't crank the engine for more than 5 - 10 seconds at a time.

OK:

Spark jumps across electrode gap.

NG

Replace or check ignition system (See page IG-1).

OK

3

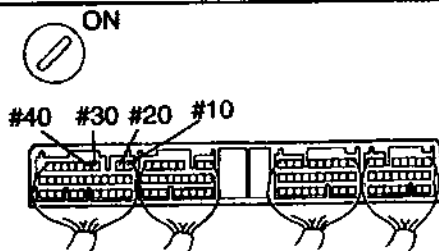
Check voltage of ECM terminal for injector of failed cylinder.BE0023
A09084

A09092

PREPARATION:

- Remove the ECM cover.
- Turn the ignition switch ON.

CHECK:

Measure voltage between applicable terminal of the ECM connector and body ground.

OK:

Voltage: 9 - 14 V

**Reference: INSPECTION USING OSCILLOSCOPE
INJECTOR SIGNAL WAVEFORM**

With the engine idling, measure between terminals #10 - #40 and E01 of the ECM connector.

HINT:

The correct waveforms are shown.

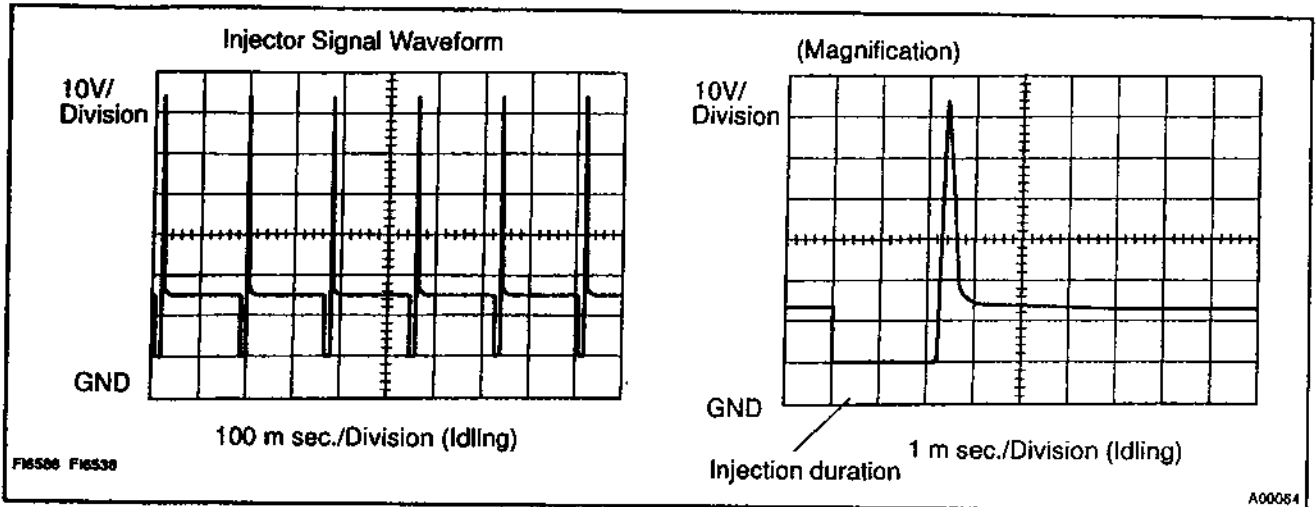

OK

Go to step 5.

NG

4

Check resistance of injector of misfiring cylinder (See page SF-18).

NG

Replace injector.

OK

Check for open and short in harness and connector between injector and ECM (See page IN-30).

5

Check fuel pressure (See page SF-6).

NG

Check and repair fuel pump, pressure regulator, fuel pipe line and filter.

OK

6 Check injector injection (See page SF-22).

NG Replace injector.

OK

7 Check mass air flow meter and engine coolant temp. sensor (See page SF-31, SF-63).

NG Repair or replace.

OK

Check compression pressure, valve clearance valve timing and locker arm (See page EM-3, EM-4, EM-22, EM-48).

DTC	P0325	Knock Sensor 1 Circuit Malfunction
------------	--------------	-------------------------------------------

CIRCUIT DESCRIPTION

The knock sensor is fitted to the cylinder block to detect engine knocking. This sensor contains a piezoelectric element which generates a voltage when it becomes deformed, which occurs when the cylinder block vibrates due to knocking. If engine knocking occurs, ignition timing is retarded to suppress it.

DTC No.	DTC Detecting Condition	Trouble Area
P0325	No knock sensor 1 signal to ECM with engine speed, 2,000 rpm or more	<ul style="list-style-type: none"> • Open or short in knock sensor 1 circuit • Knock sensor 1 (looseness) • ECM

HINT:

If the ECM detects above diagnosis conditions, it operates the fail safe function in which the corrective retard angle value is set to the maximum value.

WIRING DIAGRAM

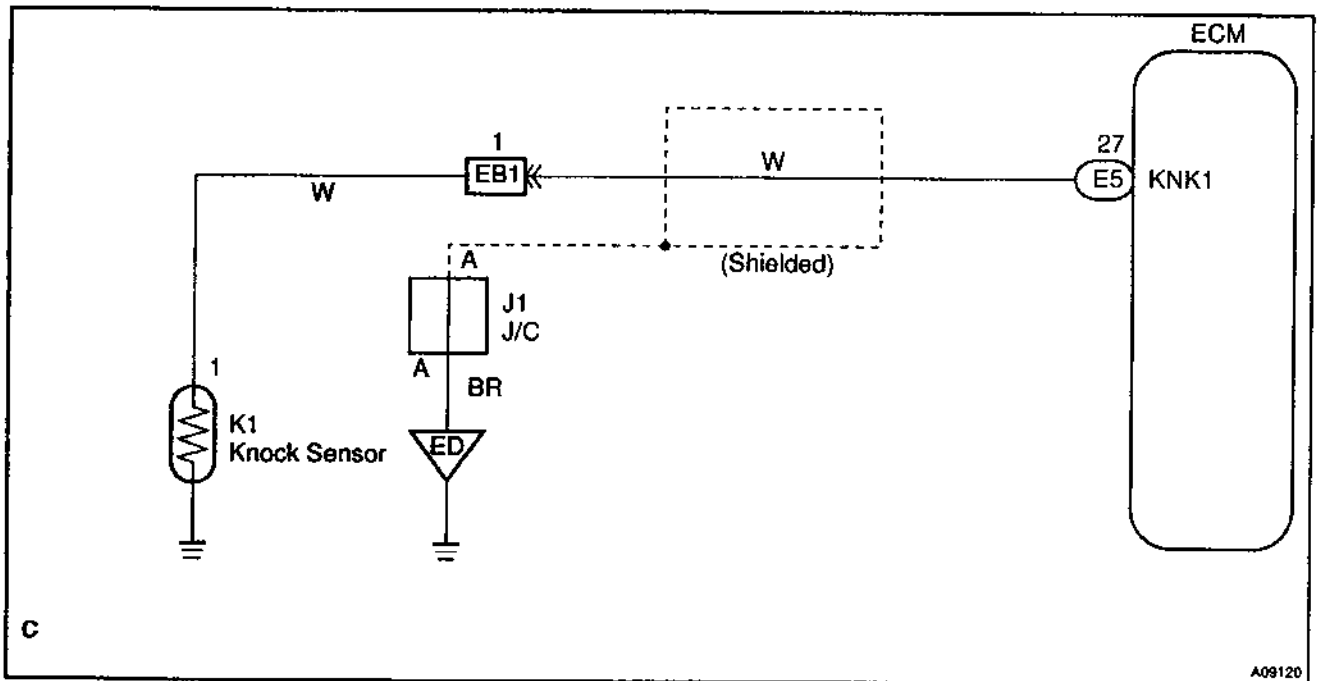

INSPECTION PROCEDURE

HINT:

Read freeze frame data using TOYOTA hand-held tester or OBD II scan tool. Because freeze frame records the engine conditions when the malfunction is detected, when troubleshooting it is useful for determining whether the vehicle was running or stopped, the engine warmed up or not, the air-fuel ratio lean or rich, etc. at the time of the malfunction.

1 Check continuity between terminal KNK of ECM connector and body ground.

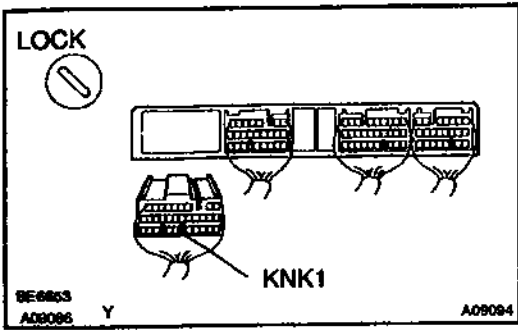

PREPARATION:

- (a) Remove the ECM cover.
- (b) Disconnect the E5 connector of the ECM.

CHECK:

Measure resistance between terminal KNK of the ECM connector and body ground.

OK:

Resistance: 1 MΩ or higher

OK → Go to step 3.

NG

2 Check knock sensor 1 (See page SF-68).

NG → Replace knock sensor 1.

OK

3 Check for open and short in harness and connector between ECM and knock sensor 1 (See page IN-30).

NG → Repair or replace harness or connector.

OK

4

Does malfunction disappear when a good knock sensor 1 is installed?

YES

Replace knock sensor 1.

NO

Check and replace ECM (See page IN-30).

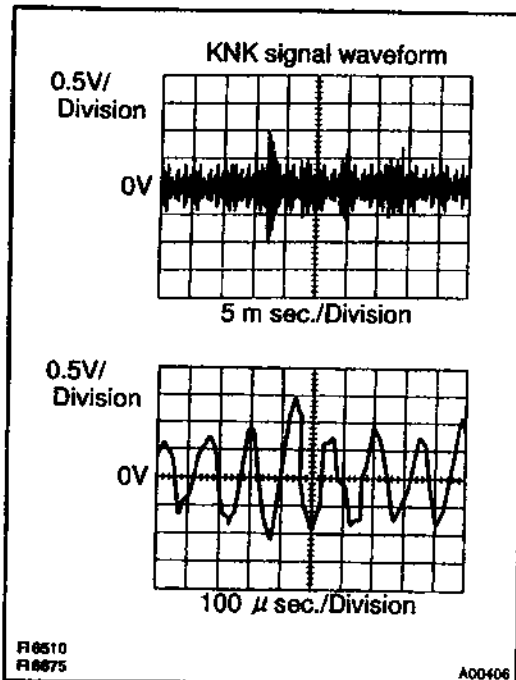
**Reference: INSPECTION USING OSCILLOSCOPE**

- With the engine racing (4,000 rpm) measure between terminal KNK of the ECM connector and body ground.

HINT:

The correct waveforms are as shown.

- Spread the time on the horizontal axis, and confirm that period of the wave is 80 μ sec.
(Normal mode vibration frequency of knock sensor:
12.5 kHz (1ZZ-FE), 7.1 kHz (2ZZ-GE))

HINT:

If normal mode vibration frequency is not 7.6 kHz the sensor is malfunctioning.

DTC**P0335****Crankshaft Position Sensor "A" Circuit Malfunction****CIRCUIT DESCRIPTION**

Crankshaft position sensor (NE signal) consist of a signal plate and pick up coil.

The NE signal plate has 34 teeth and is mounted on the crankshaft. The NE signal sensor generates 34 signals of every engine revolution. The ECM detects the standard crankshaft angle based on the G22 signals, and the actual crankshaft angle the engine speed by the NE signals.

DTC No.	DTC Detecting Condition	Trouble Area
P0335	No crankshaft position sensor signal to ECM during cranking. (2 trip detection logic)	<ul style="list-style-type: none"> • Open or short in crankshaft position sensor circuit. • Crankshaft position sensor
	No crankshaft position sensor signal to ECM with engine speed 600 rpm or more (2 trip detection logic)	<ul style="list-style-type: none"> • Signal plate (Timing belt guide) • Crankshaft timing pulley • ECM

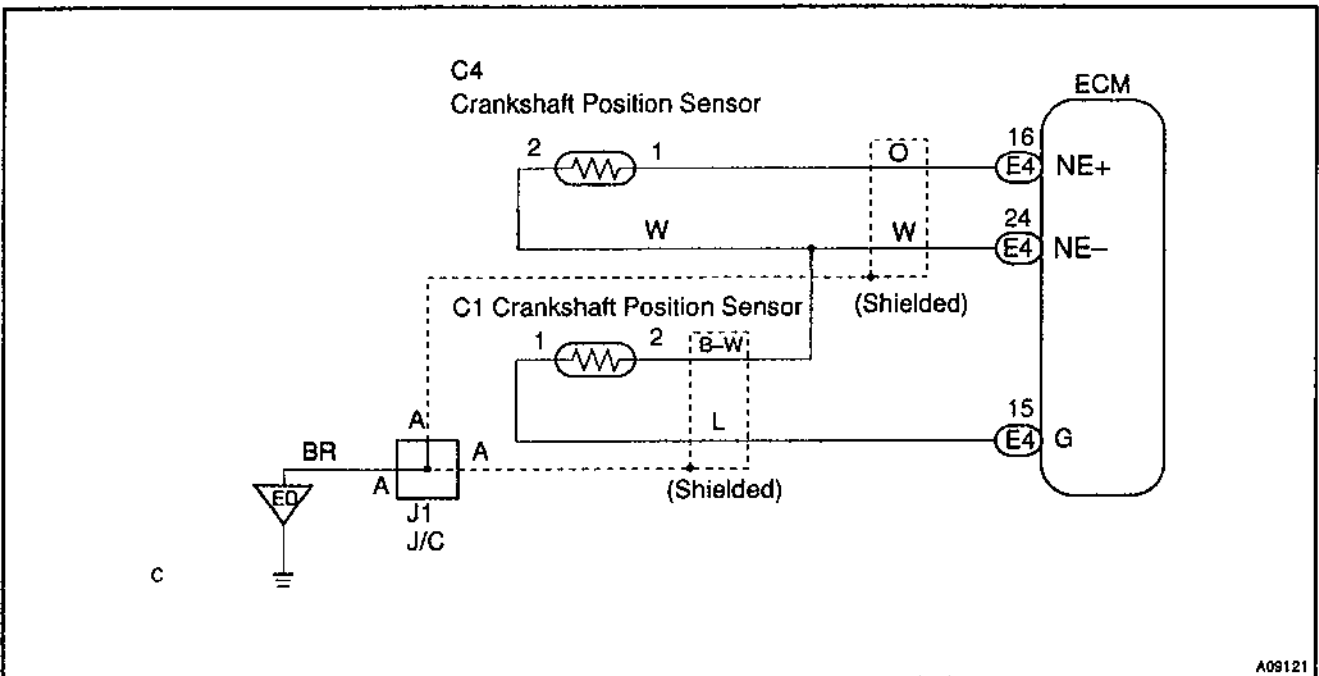
WIRING DIAGRAM

INSPECTION PROCEDURE

HINT:

- Perform troubleshooting of DTC 335 1st. If notrouble is found, troubleshoot the following mechanical system.
- Read freeze frame data using TOYOTA hand-held tester or OBD II scan tool. Because freeze frame records the engine conditions when the malfunction is detected, when troubleshooting it is useful for determining whether the vehicle was running or stopped, the engine warmed up or not, the air-fuel ratio lean or rich, etc. at the time of the malfunction.

1 Check resistance of crankshaft position sensor (See page IG-1).

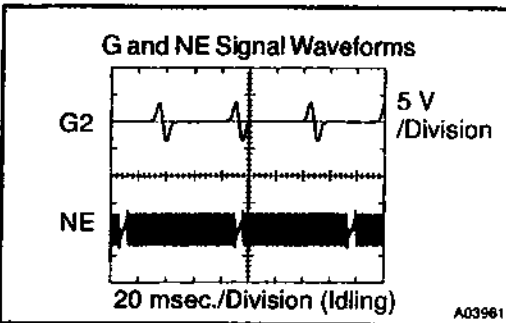

Reference: INSPECTION USING OSCILLOSCOPE

During cranking or idling, check between terminals G2 and NE-, NE and NE- of the ECM

HINT:

The correct waveforms are as shown.

NG

Replace crankshaft position sensor.

OK

2 Check for open and short in harness and connector between ECM and crankshaft position sensor (See page IN-30).

NG

Repair or replace harness or connector.

OK

3 Inspect sensor installation and teeth of crankshaft timing pulley (See page IG-11, EM-15).

NG

Tighten the sensor.
Replace crankshaft timing pulley.

OK

Check and replace ECM (See page IN-30).

DTC	P0340	Camshaft Position Sensor Circuit Malfunction
------------	--------------	-----------------------------------------------------

CIRCUIT DESCRIPTION

Camshaft position sensor (G22 signal) consist of signal plate and pick up coil. The G22 signal plate has one tooth on its outer circumference and is mounted on the exhaust camshaft. When the camshafts rotate, the protrusion on the signal plate and the air gap on the pick up coil change, causing fluctuations in the magnetic field and generating an electromotive force in the pick up coil. The NE signal plate has 34 teeth and is mounted on the crankshaft. The NE signal sensor generates 34 signals for every engine revolution. The ECM detects the standard crankshaft angle based on the G22 signals and the actual crankshaft angle and the engine speed by the NE signals.

DTC No.	DTC Detecting Condition	Trouble Area
P0340	No camshaft position sensor signal to ECM during cranking. (2 trip detection logic)	<ul style="list-style-type: none"> • Open or short in camshaft position sensor circuit • Camshaft position sensor
	No camshaft position sensor signal to ECM with engine speed 600 rpm or more	<ul style="list-style-type: none"> • Camshaft timing pulley • ECM

WIRING DIAGRAM

Refer to DTC P0335 (Crankshaft Position Sensor "A" Circuit Malfunction) on page DI-74 for the WIRING DIAGRAM.

INSPECTION PROCEDURE

HINT:

Read freeze frame data using TOYOTA hand-held tester or OBD II scan tool. Because freeze frame records the engine conditions when the malfunction is detected, when troubleshooting it is useful for determining whether the vehicle was running or stopped, the engine warmed up or not, the air-fuel ratio lean or rich, etc. at the time of the malfunction.

1	Check resistance of camshaft position sensor (Signal generator) (See page IG-1).
----------	-----------------------------------------------------------------------------------------

Reference: INSPECTION USING OSCILLOSCOPE

Refer to DTC P0335 (Crankshaft Position Sensor "A" Circuit Malfunction) on page DI-74 for the INSPECTION USING OSCILLOSCOPE.

NG	Replace camshaft position sensor.
-----------	------------------------------------------



2 Check for open and short in harness and connector between ECM and camshaft position sensor (See page IN-30).

NG

Repair or replace harness or connector.

OK

3 Inspect sensor installation and tooth of camshaft timing pulley (See page EM-15).

NG

Tighten the sensor.
Replace camshaft timing pulley.

OK

Check and replace ECM (See page IN-30).

DTC**P0420****Catalyst System Efficiency Below Threshold****CIRCUIT DESCRIPTION**

The ECM compares the waveform of the oxygen sensor located before the catalyst with the waveform of the oxygen sensor located behind the catalyst to determine whether or not catalyst performance has deteriorated.

Air-fuel ratio feedback compensation keeps the waveform of the oxygen sensor before the catalyst repeatedly changing back and forth from rich to lean.

If the catalyst is functioning normally, the waveform of the oxygen sensor behind the catalyst switches back and forth between rich and lean much more slowly than the waveform of the oxygen sensor before the catalyst.

But when both waveforms change at a similar rate, it indicates that catalyst performance has deteriorated.

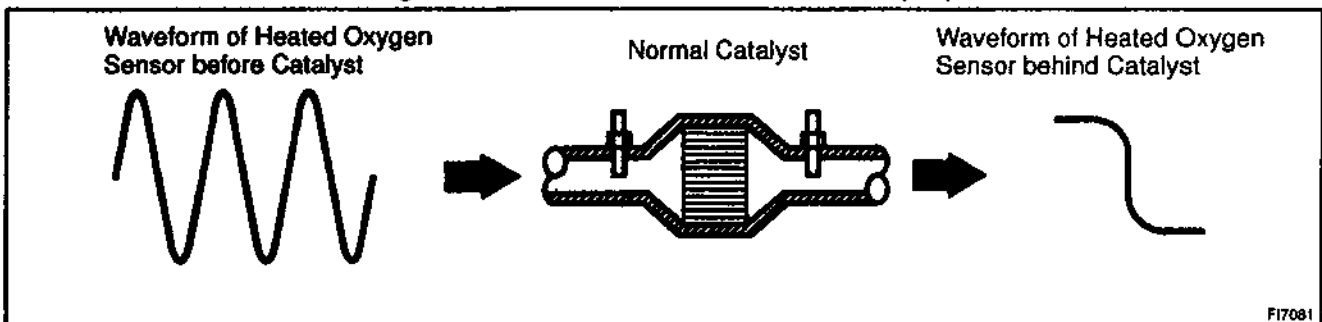

DTC No.	DTC Detecting Condition	Trouble Area
P0420	After the engine and the catalyst are warmed up, and while the vehicle is driven within the set vehicle and engine speed range, the waveforms of the oxygen sensors (bank 1 sensor 1 and bank 1 sensor 2) have the same amplitude (2 trip detection logic)	<ul style="list-style-type: none"> • Gas leakage on exhaust system • Open or short in heated oxygen sensor circuit • Heated oxygen sensor • Three-way catalytic converter

CONFIRMATION ENGINE RACING PATTERN

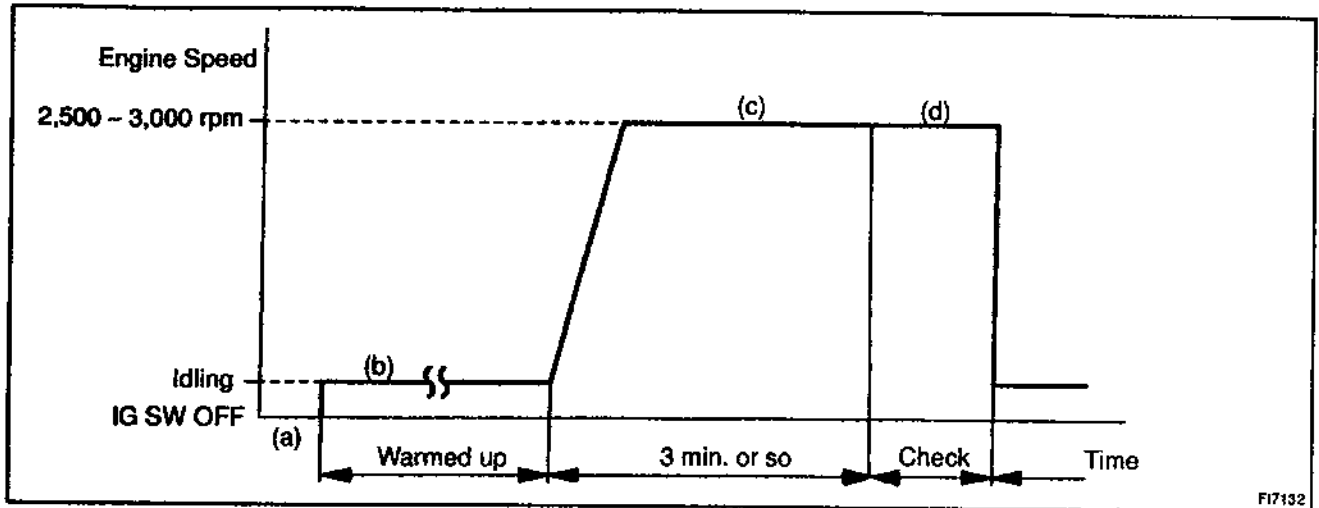

- Connect the TOYOTA hand-held tester to the DLC3, or connect the probe of the oscilloscope between terminals OX1, OX2 and E1 of the ECM connector.
- Start engine and warm it up with all accessories switched OFF until water temp. is stable.
- Race the engine at 2,500 - 3,000 rpm for about 3 min.
- After confirming that the waveforms of the oxygen sensor, bank 1 sensor 1 (OX1), oscillate around 0.5 V during feedback to the ECM, check the waveform of the oxygen sensor, bank 1 sensor 2 (OX2).

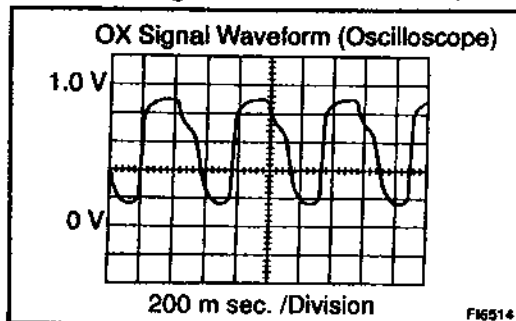

HINT:

- If there is a malfunction in the system, the waveform of the oxygen sensor, bank 1 sensor 2 (OX2), is almost the same as that of the oxygen sensor, bank 1 sensor 1 (OX1), on the left.
- There are some cases where, even though a malfunction exists, the MIL may either light up or not light up.

INSPECTION PROCEDURE**HINT:**

Read freeze frame data using TOYOTA hand-held tester or OBD II scan tool. Because freeze frame records the engine conditions when the malfunction is detected, when troubleshooting it is useful for determining whether the vehicle was running or stopped, the engine warmed up or not, the air-fuel ratio lean or rich, etc. at the time of the malfunction.

1 Are there any other codes (besides DTC P0420) being output?

YES

Go to relevant DTC chart.

NO

2 Check gas leakade on exhaust system.

NG

Repair or replace.

OK

3 Check oxygen sensor (bank 1 sensor 1) (See page DI-49).

NG

Repair or replace.

OK

4 Check oxygen sensor (bank 1 sensor 2) (See page DI-58).

NG

Repair or replace.

OK

Replace three-way catalytic converter.

DTC	P0440	Evaporative Emission Control System Malfunction
------------	--------------	--------------------------------------------------------

CIRCUIT DESCRIPTION

The vapor pressure sensor, VSV for canister closed valve (CCV) and VSV for pressure switching valve are used to detect abnormalities in the evaporative emission control system.

The ECM decides whether there is an abnormality in the evaporative emission control system based on the vapor pressure sensor signal.

DTC P0440 or P0442 is recorded by the ECM when evaporative emissions leak from the components within the dotted line in Fig. 1 below, or when the vapor pressure sensor malfunctions.

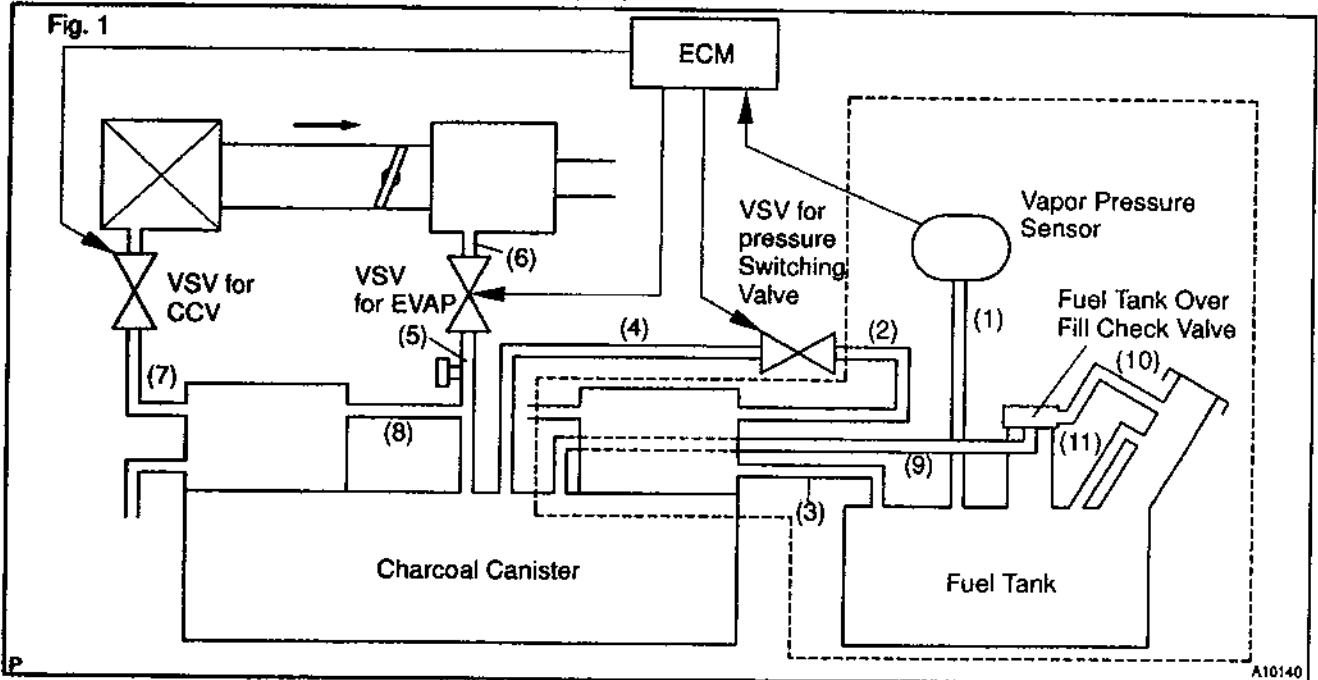

DTC No.	DTC Detecting Condition	Trouble Area
P0440	Fuel tank pressure is atmospheric pressure after vehicle is driven for 20 min. (2 trip detection logic)	<ul style="list-style-type: none"> • Hose or tube cracked, hole, damaged or loose seal ((3) in Fig. 1) • Fuel tank cap incorrectly installed • Fuel tank cap cracked or damaged • Vacuum hose cracked, holed, blocked, damaged or disconnected ((1) or (2) in Fig. 1) • Fuel tank cracked, holed or damaged • Charcoal canister cracked, holed or damaged • Open or short in vapor pressure sensor circuit • Vapor pressure sensor • Fuel tank over fill check valve cracked or damaged • ECM

WIRING DIAGRAM

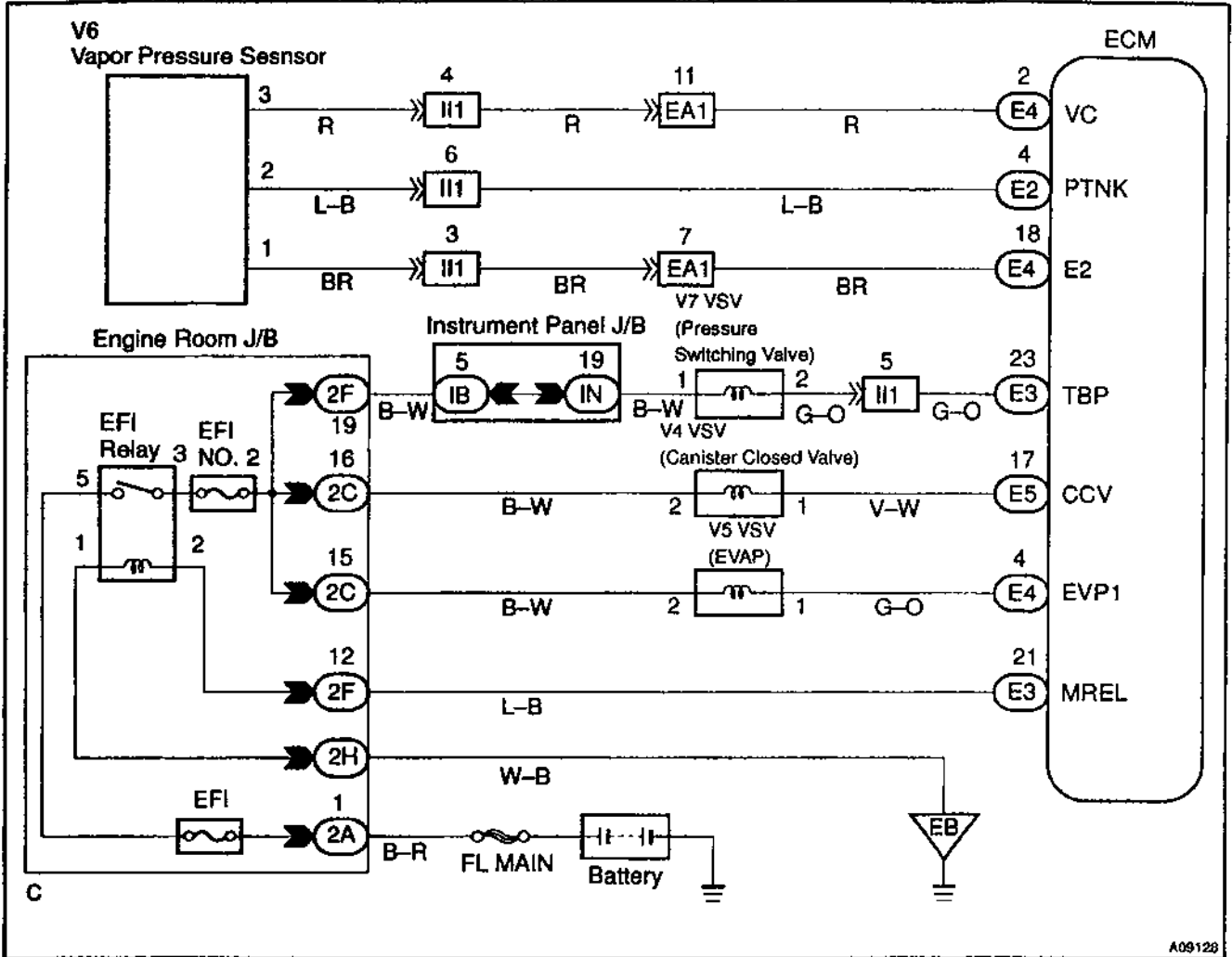

INSPECTION PROCEDURE

HINT:

- If DTC P0441, P0446, P0450 or P0451 is output after DTC P0440 or P0442, first troubleshoot DTC P0441, P0446, P0450 or P0451. If no malfunction is detected, troubleshoot DTC P0440 or P0442 next.
- Ask the customer whether, after the MIL came on, the customer found the fuel tank cap loose and tightened it. Also ask the customer whether the fuel tank cap was loose when refuelling. If the fuel tank cap was not loose, it was the cause of the DTC. If the fuel tank cap was not loose or if the customer was not sure if it was loose, troubleshoot according to the following procedure.
- Read freeze frame data using TOYOTA hand-held tester or OBD II scan tool. Because freeze frame records the engine conditions when the malfunction is detected. When troubleshooting, it is useful for determining whether the vehicle was running or stopped, the engine was warmed up or not, the air-fuel ratio was lean or rich, etc. at the time of the malfunction.
- When the ENGINE RUN TIME in the freeze frame data is less than 200 seconds, carefully check the VSV for EVAP, charcoal canister and vapor pressure sensor.

- 1 Check whether hose close to fuel tank have been modified, and check whether there are signs of any accident near fuel tank or charcoal canister.**

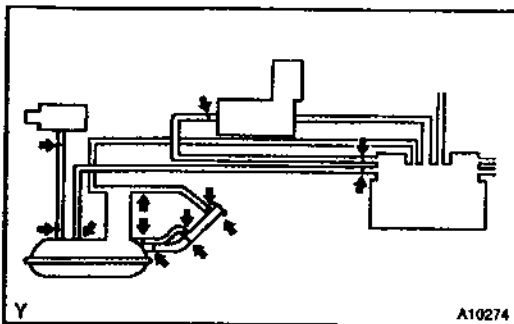
**CHECK:**

Check for cracks, deformation and loose connection of the following parts:

- Fuel tank
- Charcoal canister
- Fuel tank filler pipe
- Hoses and tubes around fuel tank and charcoal canister

NG

Repair or replace.

OK

- 2 Check that fuel tank cap is TOYOTA genuine parts.**

NG

Replace to TOYOTA genuine parts.

OK

- 3 Check that fuel tank cap is correctly installed.**

NG

Correctly Install fuel tank cap.

OK

- 4 Check fuel tank cap (See page EC-6).**

NG

Replace fuel tank cap.

OK

5 Check filler neck for damage.

PREPARATION:

Remove the fuel tank cap.

CHECK:

Visually inspect the filler neck for damage.

NG

Replace filler pipe.

OK

6 Check vacuum hoses between vapor pressure sensor and fuel tank, and charcoal canister and VSV for pressure switching valve and VSV for pressure switching valve and charcoal canister.

CHECK:

- (a) Check that the vacuum hose is connected correctly.
- (b) Check the vacuum hose for looseness and disconnection.
- (c) Check the vacuum hose for cracks, hole and damage.

NG

Repair or replace.

OK

7 Check hose and tube between fuel tank and charcoal canister.

CHECK:

- (a) Check for proper connection of the fuel tank and fuel evap pipe (See page EC-6), fuel evap pipe and fuel tube under the floor, fuel tube under the floor and charcoal canister.
- (b) Check the hose and tube for cracks, hole and damage.

NG

Repair or replace.

OK

8 Check charcoal canister for cracks, hole and damage (See page EC-6).

NG

Replace charcoal canister.

OK

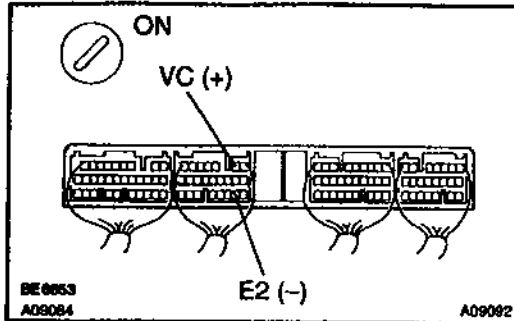
9 Check voltage between terminals VC and E2 of ECM connector.**CHECK:**

- Remove the ECM cover.
- Turn the ignition switch ON.

CHECK:

Measure the voltage between terminals VC and E2 of the ECM connector.

OK:

Voltage: 4.5 - 5.5 V

NG

Check and replace ECM (See page IN-30).

OK

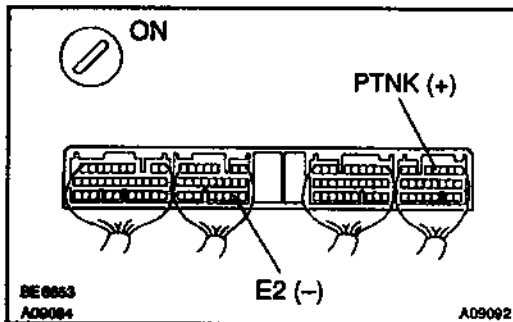
10 Check voltage between terminals PTNK and E2 of ECM connectors.**PREPARATION:**

- Remove the ECM cover.
- Remove the fuel tank cap.
- Turn the ignition switch ON.

CHECK:

Measure the voltage between terminals PTNK and E2 of the ECM connectors.

OK:

Voltage: 3.3 V

OK

Go to step 12.

NG

11 Check for open and short in harness and connector between vapor pressure sensor and ECM (See page IN-30).

NG

Repair or replace harness or connector.

OK

Replace vapor pressure sensor.

12 Check fuel tank and fuel tank over fill check valve for cracks and damage.

NG

Replace fuel tank or fuel tank over fill check valve.

OK

It is likely that vehicle user did not properly close fuel tank cap. Please explain to customer how to properly install fuel tank cap.

DTC	P0441	Evaporative Emission Control System Incorrect Purge Flow
------------	--------------	---------------------------------------------------------------------

DTC	P0446	Evaporative Emission Control System Vent Control Malfunction
------------	--------------	-------------------------------------------------------------------------

CIRCUIT DESCRIPTION

The vapor pressure sensor, VSV for canister closed valve (CCV), VSV for pressure switching valve are used to detect abnormalities in the evaporative emission control system.

The ECM decides whether there is an abnormality in the evaporative emission control system based on the vapor pressure sensor signal.

DTCs P0441 and P0446 are recorded by the ECM when evaporative emissions leak from the components within the dotted line in Fig. 1 below, or when there is a malfunction in either the VSV for EVAP, the VSV for pressure switching valve, or in the vapor pressure sensor itself.

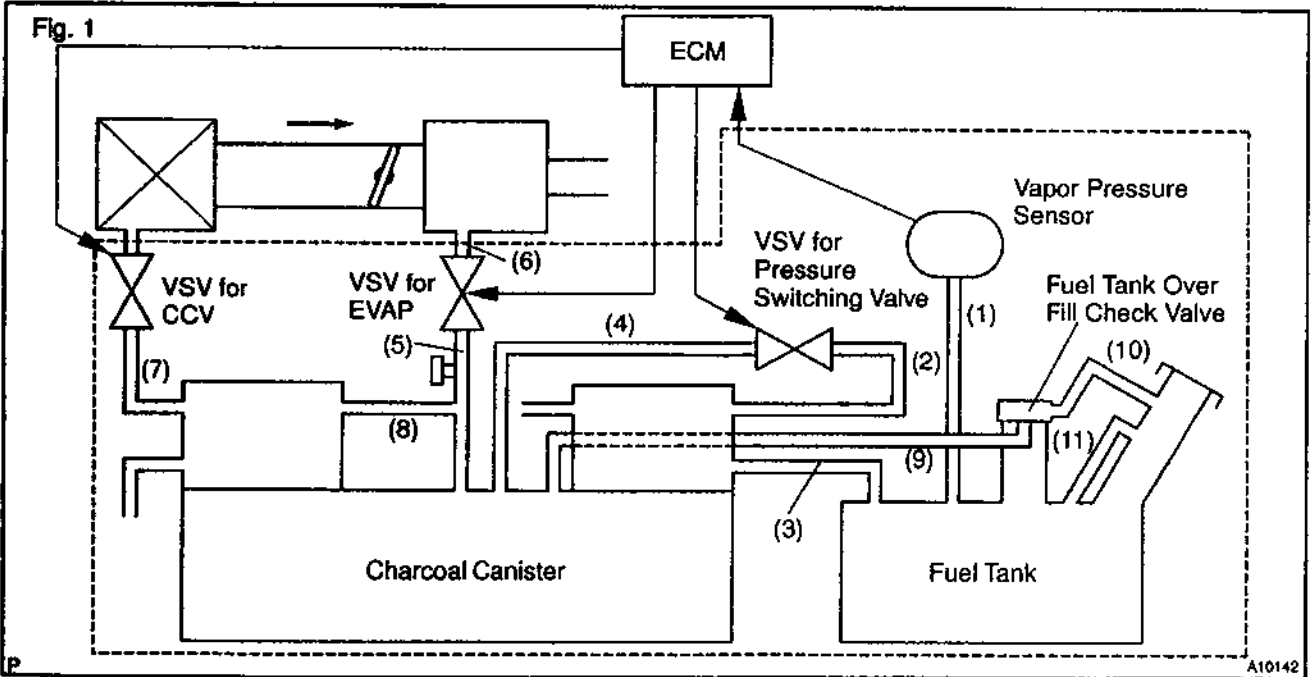

DTC No.	DTC Detecting Condition	Trouble Area
P0441	Pressure in charcoal canister does not drop during purge control (2 trip detection logic)	<ul style="list-style-type: none"> • Open or short in vapor pressure sensor circuit • Vapor pressure sensor
	During purge cut-off, pressure in charcoal canister is very low compared with atmospheric pressure (2 trip detection logic)	
P0446	When VSV for pressure switching valve is turned OFF, pressure in fuel tank is maintained at atmospheric pressure (2 trip detection logic)	<ul style="list-style-type: none"> • Open or short in VSV circuit for EVAP • VSV for EVAP • Open or short in VSV circuit for vapor pressure sensor • VSV for vapor pressure sensor • Charcoal canister cracked, hole or damaged • Fuel tank over fill check valve cracked or damaged • ECM
	When VSV for pressure switching valve is OFF, ECM judges that there is no continuity between vapor pressure sensor and fuel tank (2 trip detection logic)	
	When VSV for CCV is ON, pressure in charcoal canister and fuel tank is maintained at atmospheric pressure (2 trip detection logic)	

WIRING DIAGRAM

Refer to DTC P0440 on page DI-81.

INSPECTION PROCEDURE

HINT:

- If DTC P0441, P0446, P0450 or P0451 is output after DTC P0440, first troubleshoot DTC P0441, P0446, P0450 or P0451. If no malfunction is detected, troubleshoot DTC P0440 next.
- Read freeze frame data using TOYOTA hand-held tester or OBD II scan tool. Because freeze frame records the engine conditions when the malfunction is detected. When troubleshooting, it is useful for determining whether the vehicle was running or stopped, the engine was warmed up or not, the air-fuel ratio was lean or rich, etc. at the time of the malfunction.
- When the ENGINE RUN TIME in the freeze frame data is less than 200 seconds, carefully check the VSV for EVAP, charcoal canister and vapor pressure sensor.

TOYOTA hand-held tester:

1	Check whether hose close to fuel tank have been modified, and check whether there are signs of any accident near fuel tank or charcoal canister (See page DI-81).
----------	--------------------------------------------------------------------------------------------------------------------------------------------------------------------------

NG

Repair or replace.

OK

2	Check that fuel tank cap is TOYOTA genuine parts.
----------	----------------------------------------------------------

NG

Replace to TOYOTA genuine parts.

OK

3 Check that fuel tank cap is correctly installed.

NG

Correctly install fuel tank cap.

OK

4 Check fuel tank cap (See page EC-6).

NG

Replace fuel tank cap.

OK

5 Check filler neck for damage.

NG

Replace filler pipe.

OK

6 Check vacuum hoses between vapor pressure sensor and fuel tank, and charcoal canister and VSV for pressure switching valve and VSV for pressure switching valve and charcoal canister.

NG

Repair or connect VSV or sensor connector.

OK

7 Check hose and tube between fuel tank and charcoal canister.

NG

Repair or replace.

OK

- 8** Check VSV connector for EVAP, VSV connector for CCV, VSV connector for pressure switching valve and vapor pressure sensor connector for looseness and disconnection.

NG

Repair or connect VSV or sensor connector.

OK

- 9** Check vacuum hoses ((8), (9), (10) and (11) in Fig. 1 in circuit description).

CHECK:

- (a) Check that the vacuum hose is connected correctly.
- (b) Check the vacuum hose for looseness and disconnection.
- (c) Check the vacuum hose for cracks, hole, damage and blockage.

NG

Repair or replace.

OK

- 10** Check voltage between terminals VC and E2 of ECM connector (See page DI-81).

NG

Check and replace ECM (See page IN-30).

OK

- 11** Check voltage between terminals PTNK and E2 of ECM connectors (See page DI-81).

OK

Go to step 13.

NG

- 12** Check for open and short in harness and connector between vapor pressure sensor and ECM (See page IN-30).

NG

Repair or replace harness or connector.

OK

Replace vapor pressure sensor.

- 13** Check purge flow.

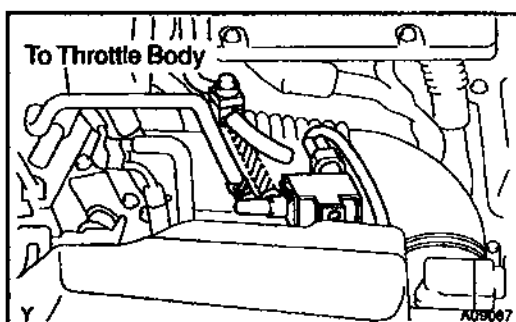

PREPARATION:

- Connect the TOYOTA hand-held tester to the DLC3.
- Select the ACTIVE TEST mode on the TOYOTA hand-held tester.
- Disconnect the vacuum hose from the VSV for the EVAP from the charcoal canister.
- Start the engine.

CHECK:

When the VSV for the EVAP is operated by the TOYOTA hand-held tester, check whether the disconnected hose applies suction to your finger.

OK:

VSV is ON:

Disconnected hose applies suction to your finger.

VSV is OFF:

Disconnected hose applies no suction to your finger.

OK

Go to step 16.

NG

14 Check vacuum hose between intake manifold and VSV for EVAP, and VSV for EVAP and charcoal canister.

CHECK:

- (a) Check that the vacuum hose is connected correctly.
- (b) Check the vacuum hose for looseness and disconnection.
- (c) Check the vacuum hose for cracks, hole, damage and blockage.

NG

Repair or replace.

OK

15 Check operation of VSV for EVAP (See page SF-57).

OK

Go to step 16.

NG

Replace VSV and charcoal canister, and then clean the vacuum hose between throttle body and VSV for EVAP, and VSV for EVAP and charcoal canister.

16 Check for open and short in harness and connector between EFI main relay (Marking: EFI) and VSV for EVAP, and VSV for EVAP and ECM (See page IN-30).

NG

Repair or replace harness or connector.

OK

Check and replace ECM (See page IN-30).

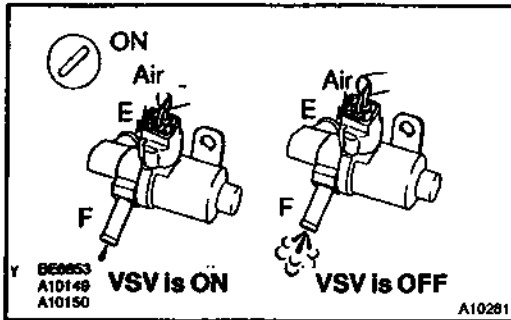
17 Check VSV for CCV.

PREPARATION:

- Connect the TOYOTA hand-held tester to the DLC3.
- Disconnect the vacuum hose for the VSV for the CCV from the charcoal canister.
- Turn the ignition switch ON and push the TOYOTA hand-held tester main switch ON.
- Select the ACTIVE TEST mode on the TOYOTA hand-held tester.

CHECK:

Check the VSV operation when it is operated by the TOYOTA hand-held tester.

OK:

VSV is ON:

Air does not flow from port E to port F.

VSV is OFF:

Air from port E flows out through port F.

OK

Go to step 21.

NG
18 Check vacuum hose between VSV for CCV and charcoal canister.
CHECK:

- Check that the vacuum hose is connected correctly.
- Check the vacuum hose for looseness and disconnection.
- Check the vacuum hose for cracks, hole damage and blockage.

NG

Repair or replace.

OK
19 Check operation of VSV for CCV.
OK

Go to step 20.

NG

Replace VSV and charcoal canister, and then clean vacuum hose between charcoal canister and VSV for CCV.

20 Check for open and short in harness and connector between EFI main relay (Marking: EFI) and VSV for CCV, and VSV for CCV and ECM (See page IN-30).

NG

Repair or replace harness or connector.

OK

Check and replace ECM (See page IN-30).

21 Check VSV for pressure switching valve.

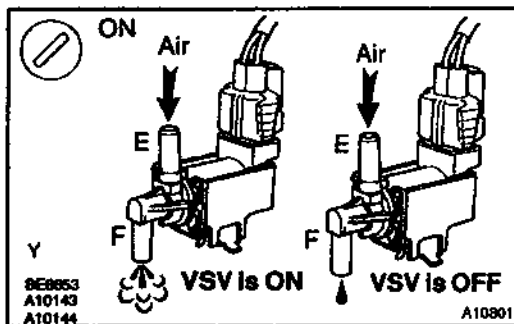

PREPARATION:

- Connect the TOYOTA hand-held tester to the DLC3.
- Turn the ignition switch ON and push the TOYOTA hand-held tester main switch ON.
- Select the ACTIVE TEST mode on the TOYOTA hand-held tester.

CHECK:

Check the VSV operation when it is operated by the TOYOTA hand-held tester.

OK:

VSV is ON:

Air from port E flows out through port F.

VSV is OFF:

Air does not flow from port E to port F.

OK

Go to step 24.

NG

22 Check operation of VSV for pressure switching valve (See page SF-61).

OK

Go to step 23.

NG

Replace VSV and charcoal canister, and then clean vacuum hose between charcoal canister and VSV for pressure switching valve, and VSV for pressure switching valve and fuel tank.

23 Check for open and short in harness and connector between EFI main relay (Marking: EFI) and VSV for pressure switching valve, and VSV for pressure switching valve and ECM (See page IN-30).

NG Repair or replace harness or connector.

OK

Check and replace ECM (See page IN-30).

24 Check fuel tank.

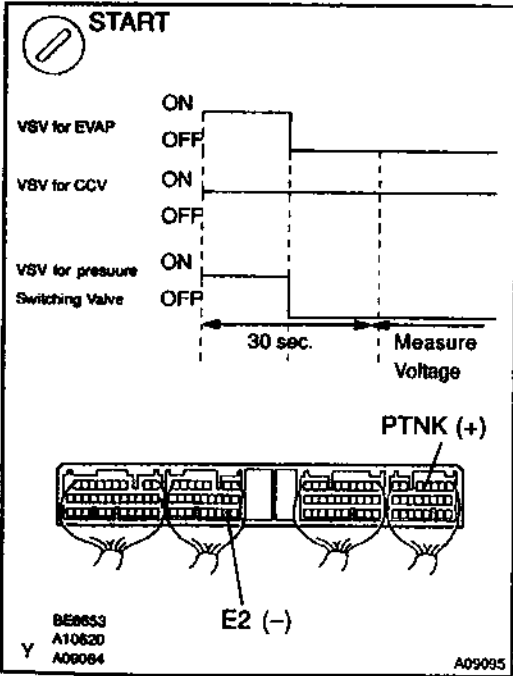

- PREPARATION:**
- (a) Remove the ECM cover.
 - (b) Connect the TOYOTA hand-held tester to the DLC3.
 - (c) Select the ACTIVE TEST mode on the TOYOTA hand-held tester.
 - (d) Start the engine.
 - (e) The VSV for the CCV is ON by the TOYOTA hand-held tester.
 - (f) The VSV for the EVAP is OFF, and the VSV for the pressure switching valve is ON by the TOYOTA hand-held tester and remains on for 30 sec.

CHECK:
Measure the voltage between terminals PTNK and E2 of the ECM connectors after switching the VSV for the EVAP from OFF to ON, and the VSV for the pressure switching valve from ON to OFF.

OK:
Voltage: 2.5 V or less

NG Replace fuel tank.

OK

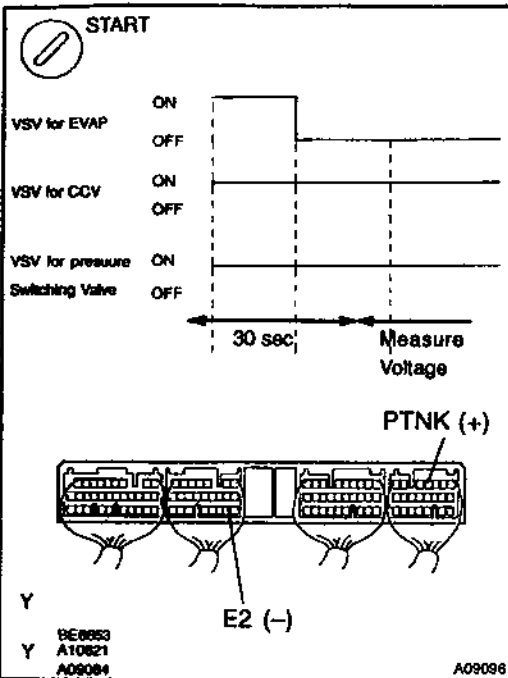
25 Check charcoal canister.

PREPARATION:

- Remove the ECM cover.
- Connect the TOYOTA hand-held tester to the DLC3.
- Select the ACTIVE TEST mode on the TOYOTA hand-held tester.
- Start the engine.
- The VSV for the CCV and the VSV for the pressure switching valve are ON by the TOYOTA hand-held tester.
- The VSV for the EVAP is OFF by the TOYOTA hand-held tester and remains on for 30 sec.

CHECK:

Measure the voltage between terminals PTNK and E2 of the ECM connectors after switching the VSV for the EVAP from OFF to ON.

OK:

Voltage: 2.5 V or less

NG

Replace charcoal canister.

OK

26 Remove charcoal canister and check it (See page EC-6).

NG

Replace charcoal canister.

OK

27 Check fuel tank over fill check valve (See page EC-6).

NG

Replace fuel tank over fill check valve or fuel tank.

OK

Check and replace ECM (See page IN-30).

OBD II scan tool (excluding TOYOTA hand-held tester):

- 1** Check whether hose close to fuel tank have been modified, and check whether there are signs of any accident near fuel tank or charcoal canister.

NG Repair or replace.

OK

- 2** Check that fuel tank cap is TOYOTA genuine parts.

NG Replace to TOYOTA genuine parts.

OK

- 3** Check that fuel tank cap is correctly installed.

NG Correctly install fuel tank cap.

OK

- 4** Check fuel tank cap (See page EC-6).

NG Replace fuel tank cap.

OK

- 5** Check filler neck for damage.

NG Replace filler pipe.

OK

- 6** Check VSV connector for EVAP, VSV connector for CCV, VSV connector for pressure switching valve and vapor pressure sensor connector for looseness and disconnection.

NG

Repair or connect VSV or sensor connector.

OK

- 7** Check vacuum hoses ((8), (9), (10) and (11) in Fig. 1 in circuit description).

CHECK:

- (a) Check that the vacuum hose is connected correctly.
- (b) Check the vacuum hose for looseness and disconnection.
- (c) Check the vacuum hose for cracks, hole damage and blockage.

NG

Repair or replace.

OK

- 8** Check voltage between terminals VC and E2 of ECM connector (See page DI-81).

NG

Check and replace ECM (See page IN-30).

OK

- 9** Check voltage between terminals PTNK and E2 of ECM connectors (See page DI-81).

OK

Go to step 11.

NG

- 10 Check for open and short in harness and connector between vapor pressure sensor and ECM (See page IN-30).**

NG

Repair or replace harness or connector.

OK

Replace vapor pressure sensor.

- 11 Check VSV for EVAP.**

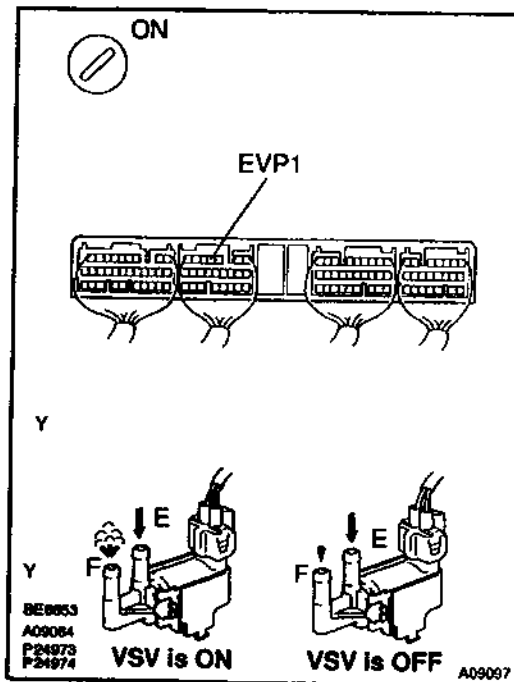
**PREPARATION:**

- Remove the ECM cover.
- Turn the ignition switch ON.

CHECK:

Check VSV function.

- Connect between terminal EVP1 of the ECM connector and body ground (VSV ON).
- Disconnect between terminal EVP1 of the ECM connector and body ground (VSV OFF).

OK:

- VSV is ON:**
Air from port E flows out through port F.
- VSV is OFF:**
Air does not flow from port E to port F.

OK

Go to step 14.

NG

12 Check operation of VSV for EVAP (See page SF-57).

NG Go to step 13.

NG

Replace VSV and clean vacuum hoses between throttle body and VSV for EVAP, and VSV for EVAP and charcoal canister, and then check charcoal canister.

13 Check for open and short in harness and connector between EFI main relay (Marking: EFI) and VSV for EVAP, and VSV for EVAP and ECM (See page IN-30)

NG Repair or replace harness or connector.

OK

Check and replace ECM (See page IN-30).

14 Check VSV for CCV.

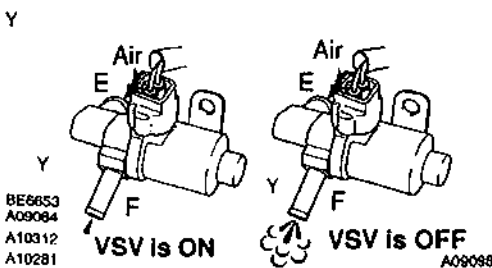
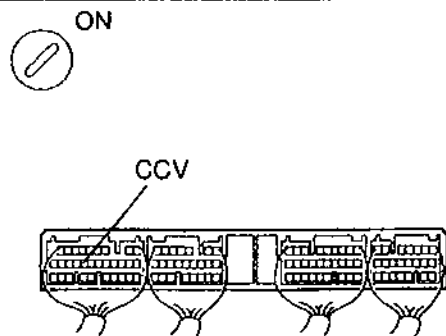

PREPARATION:

- Remove the ECM cover.
- Turn the ignition switch ON.

CHECK:

Check the VSV function.

- Connect between terminal CCV of the ECM connector and body ground (VSV ON).
- Disconnect between terminal CCV of the ECM connector and body ground (VSV OFF).

OK:

VSV is ON:

Air does not flow from port E to port F.

VSV is OFF:

Air from port E flows out through port F.

OK Go to step 17.

NG

15 Check operation of VSV for CCV (See page SF-59).

OK

Go to step 16.

NG

Replace VSV and charcoal canister, and then clean vacuum hoses between charcoal canister and VSV for CCV.

16 Check for open and short in harness and connector between EFI main relay (Marking: EFI) and VSV for CCV, and VSV for CCV and ECM (See page IN-30).

NG

Repair or replace harness or connector.

OK

Check and replace ECM (See page IN-30).

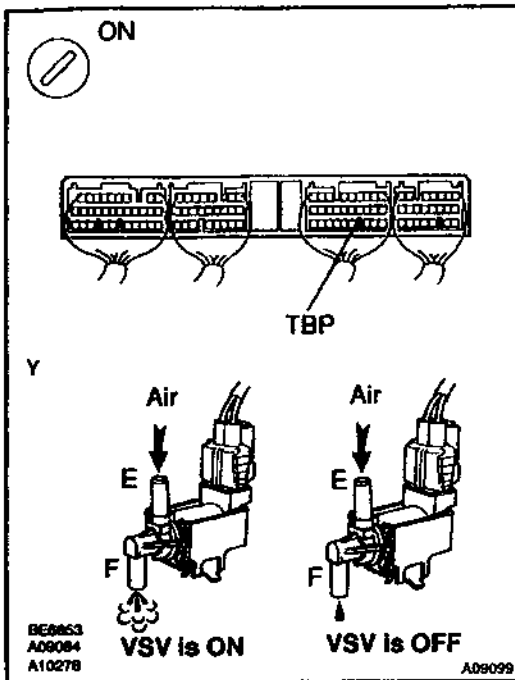
17 Check VSV for pressure switching valve.
**PREPARATION:**

- (a) Remove the ECM cover.
- (b) Turn the ignition switch ON.

CHECK:

Check the VSV function.

- (1) Connect between terminal TBP of the ECM connector and body ground (VSV ON).
- (2) Disconnect between terminal TBP of the ECM connector and body ground (VSV OFF).

OK:

- (1) VSV is ON:
Air from port E flows out through port F.
- (2) VSV is OFF:
Air does not flow from port E to port F.

OK

Go to step 20.

NG

18 Check operation of VSV for pressure switching valve (See page SF-61).

OK

Go to step 19.

NG

Replace VSV and charcoal canister, and then clean vacuum hoses between charcoal canister and VSV for pressure switching valve, and VSV for pressure switching valve and fuel tank.

19 Check for open and short in harness and connector between EFI main relay (Marking: EFI) and VSV for pressure switching valve, and VSV for pressure switching valve and ECM (See page IN-30).

NG

Repair or replace harness or connector.

OK

Check and replace ECM (See page IN-30).

20 Check fuel tank over fill check valve (See page EC-6).

NG

Replace fuel tank over fill check valve or fuel tank.

OK

Check and replace charcoal canister (See page EC-6).

DTC	P0450	Evaporative Emission Control System Pressure Sensor Malfunction
------------	--------------	------------------------------------------------------------------------

DTC	P0451	Evaporative Emission Control System Pressure Sensor Range/Performance
------------	--------------	------------------------------------------------------------------------------

CIRCUIT DESCRIPTION

The vapor pressure sensor, VSV for canister closed valve (CCV) and VSV for pressure switching valve are used to detect abnormalities in the evaporative emission control system.

The ECM decides whether there is an abnormality in the evaporative emission control system based on the vapor pressure sensor signal.

DTC P0450 or P0451 is recorded by the ECM when the vapor pressure sensor malfunction.

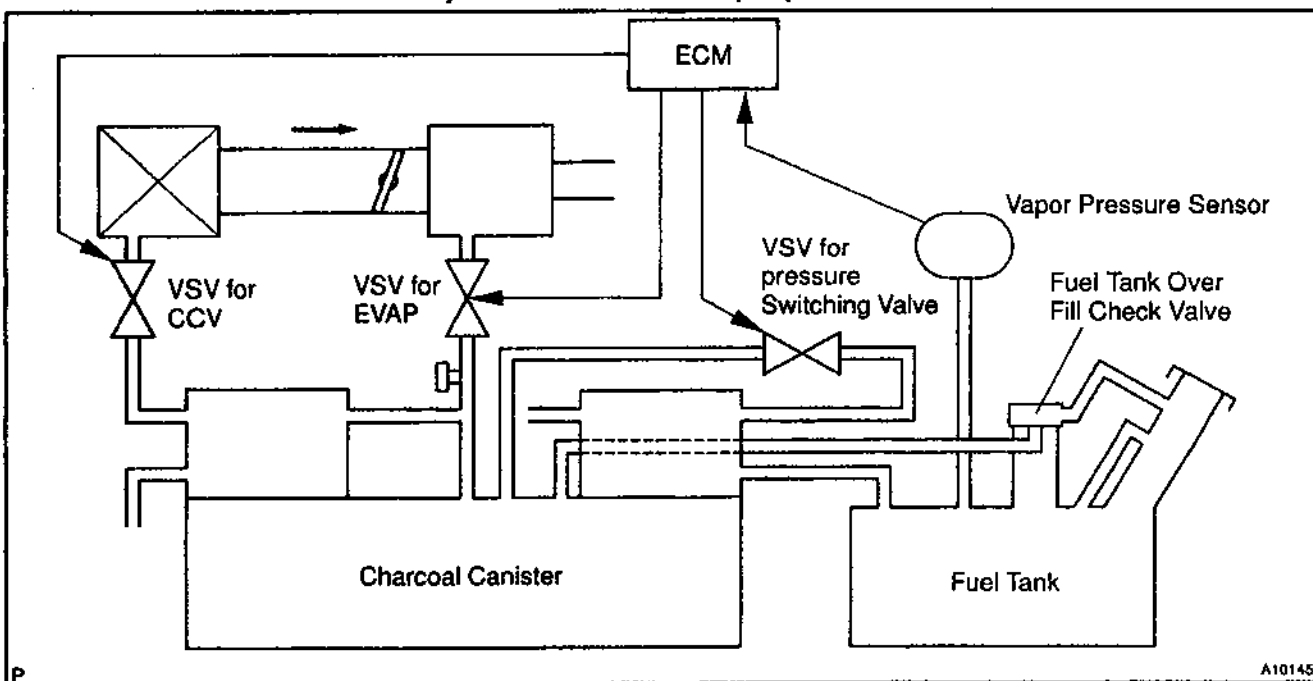

DTC No.	DTC Detecting Condition	Trouble Area
P0450	10 seconds or less after engine starting condition (a) or (b) continues for 7 seconds or more: (2 trip detection logic) (a) Vapor pressure sensor value < -4.0 kPa (~ 30 mmHg, -1.2 in.Hg) (b) Vapor pressure sensor value ≥ 2.0 kPa (15 mmHg, 0.6 in.Hg)	<ul style="list-style-type: none"> • Open or short in vapor pressure sensor circuit • Vapor pressure sensor • ECM
P0451	Vapor pressure sensor output extremely changes under conditions of (a) or (b): (2 trip detection logic) (a) Vehicle speed: 0 km/h (0mph), Engine speed: idling and VSV for pressure switching valve is OFF (b) High vapor pressure sensor	

WIRING DIAGRAM

Refer to DTC P0440 on page DI-81.

INSPECTION PROCEDURE**HINT:**

- If DTC P0441, P0446, P0450 or P0451 is output after DTC P0440, first trouble shoot DTC P0441, P0446 P0450 or P0451. If no malfunction is detected, troubleshoot DTC P0440 next.
- Read freeze frame data using TOYOTA hand-held tester or OBD II scan tool. Because freeze frame records the engine conditions when the malfunction is detected. When troubleshooting, it is useful for determining whether the vehicle was running or stopped, the engine was warmed up or not, the air-fuel ratio was lean or rich, etc. at the time of the malfunction.
- When the ENGINE RUN TIME in the freeze frame data is less than 200 seconds, carefully check the VSV for EVAP, charcoal canister and vapor pressure sensor.

1	Check voltage between terminals VC and E2 of ECM connector (See page DI-81).
----------	-------------------------------------------------------------------------------------

NG

Check and replace ECM (See page IN-30).

OK

2	Check voltage between terminals PTNK and E2 of ECM connectors (See page DI-81).
----------	----------------------------------------------------------------------------------------

OK

Check and replace ECM (See page IN-30).

NG

3	Check for open and short in harness and connector between vapor pressure sensor and ECM (See page IN-30).
----------	------------------------------------------------------------------------------------------------------------------

NG

Repair or replace harness or connector.

OK

Replace vapor pressure sensor.

DTC	P0500	Vehicle Speed Sensor Malfunction
------------	--------------	-----------------------------------------

CIRCUIT DESCRIPTION

The No.1 vehicle speed sensor outputs a 4-pulse signal for every revolution of the rotor shaft, which is rotated by the transmission output shaft via the driven gear. After this signal is converted into a more precise rectangular waveform by the waveform shaping circuit inside the combination meter, it is then transmitted to the ECM. The ECM determines the vehicle speed based on the frequency of these pluse signals.

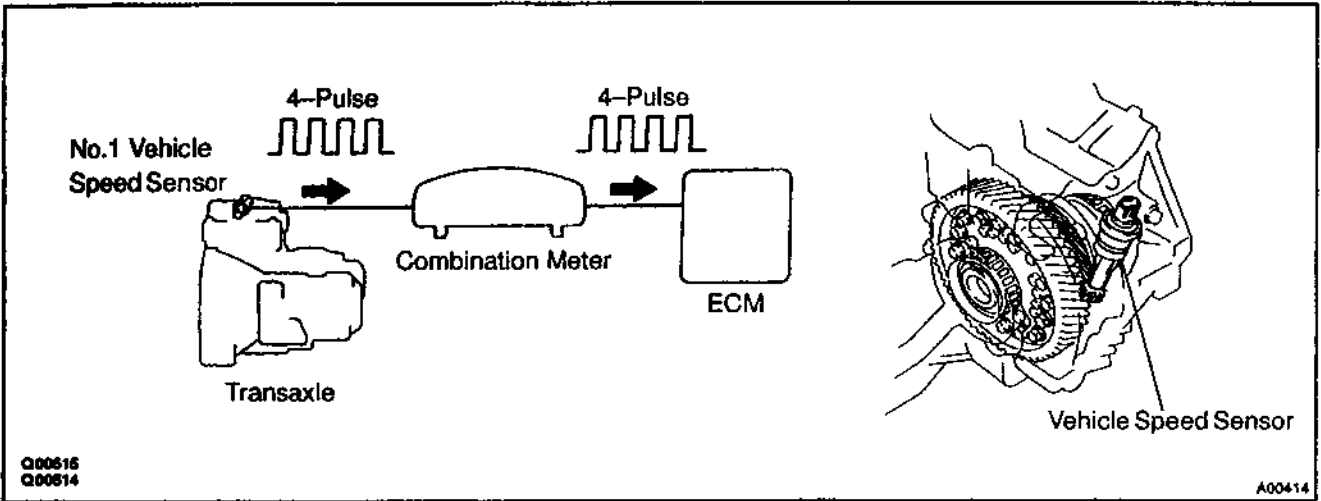

DTC No.	DTC Detecting Condition	Trouble Area
P0500	During vehicle is being driven, no vehicle speed sensor signal to ECM (2 trip detection logic)	<ul style="list-style-type: none"> • Combination meter • Open or short in vehicle speed sensor circuit • Vehicle speed sensor • ECM

WIRING DIAGRAM

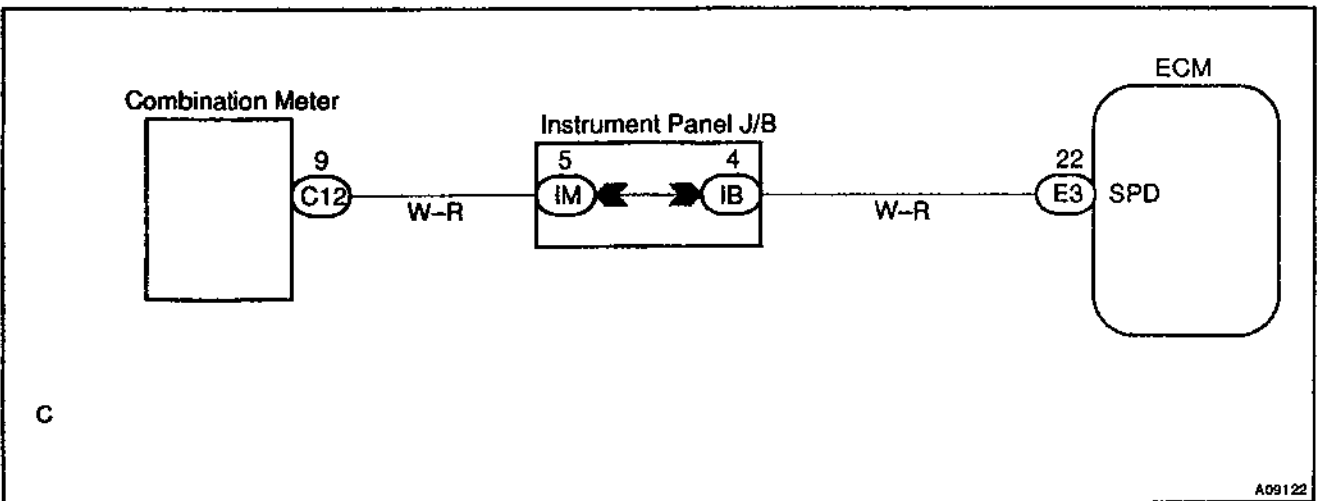

INSPECTION PROCEDURE

HINT:

Read freeze frame data using TOYOTA hand-held tester or OBD II scan tool. Because freeze frame records the engine conditions when the malfunction is detected, when troubleshooting it is useful for determining whether the vehicle was running or stopped, the engine warmed up or not, the air-fuel ratio lean or rich, etc. at the time of the malfunction.

1 Check operation of speedometer.

CHECK:

Drive the vehicle and check if the operation of the speedometer in the combination meter is normal.

HINT:

The vehicle speed sensor is operating normally if the speedometer display is normal.

NG

Check speedometer circuit. See combination meter troubleshooting (See page BE-2).

OK

2 Check voltage between terminal SPD of ECM connector and body ground.

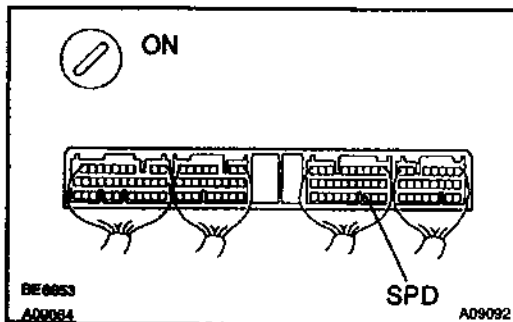

PREPARATION:

- Remove the ECM cover.
- Shift the shift lever to neutral.
- Jack up one of the front wheels.
- Turn the ignition switch ON.

CHECK:

Measure voltage between terminal SPD of ECM connector and body ground when the wheel is turned slowly.

OK:

Voltage is generated intermittently.

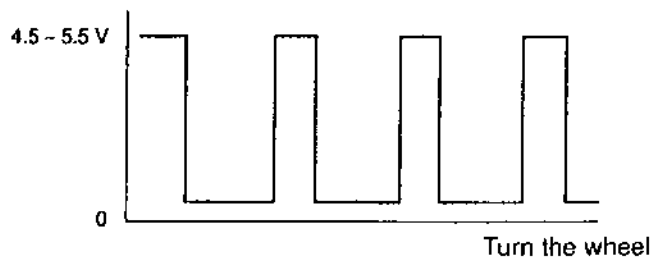

AT7808

NG

Check and repair harness and connector between combination meter and ECM.

OK

Check and replace ECM (See page IN-30).

DTC	P0505	Idle Control System Malfunction
------------	--------------	----------------------------------------

CIRCUIT DESCRIPTION

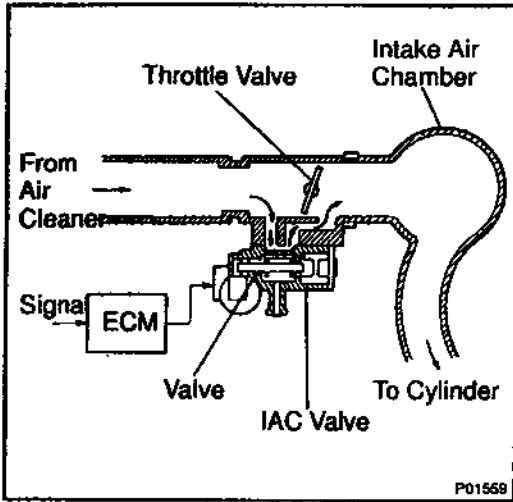

The rotary solenoid type IAC valve is located on the throttle body and intake air bypassing the throttle valve is directed to the IAC valve through a passage. In this way the intake air volume bypassing the throttle valve is regulated, controlling the engine speed. The ECM operates only the IAC valve to perform idle-up and provide feedback for the target idling speed.

DTC No.	DTC Detecting Condition	Trouble Area
P0505	Idle speed continues to vary greatly from the target speed (2 trip detection logic)	<ul style="list-style-type: none"> • IAC valve is stuck or closed • Open or short in IAC valve circuit • Open or short in A/C switch circuit • Air induction system • ECM

WIRING DIAGRAM

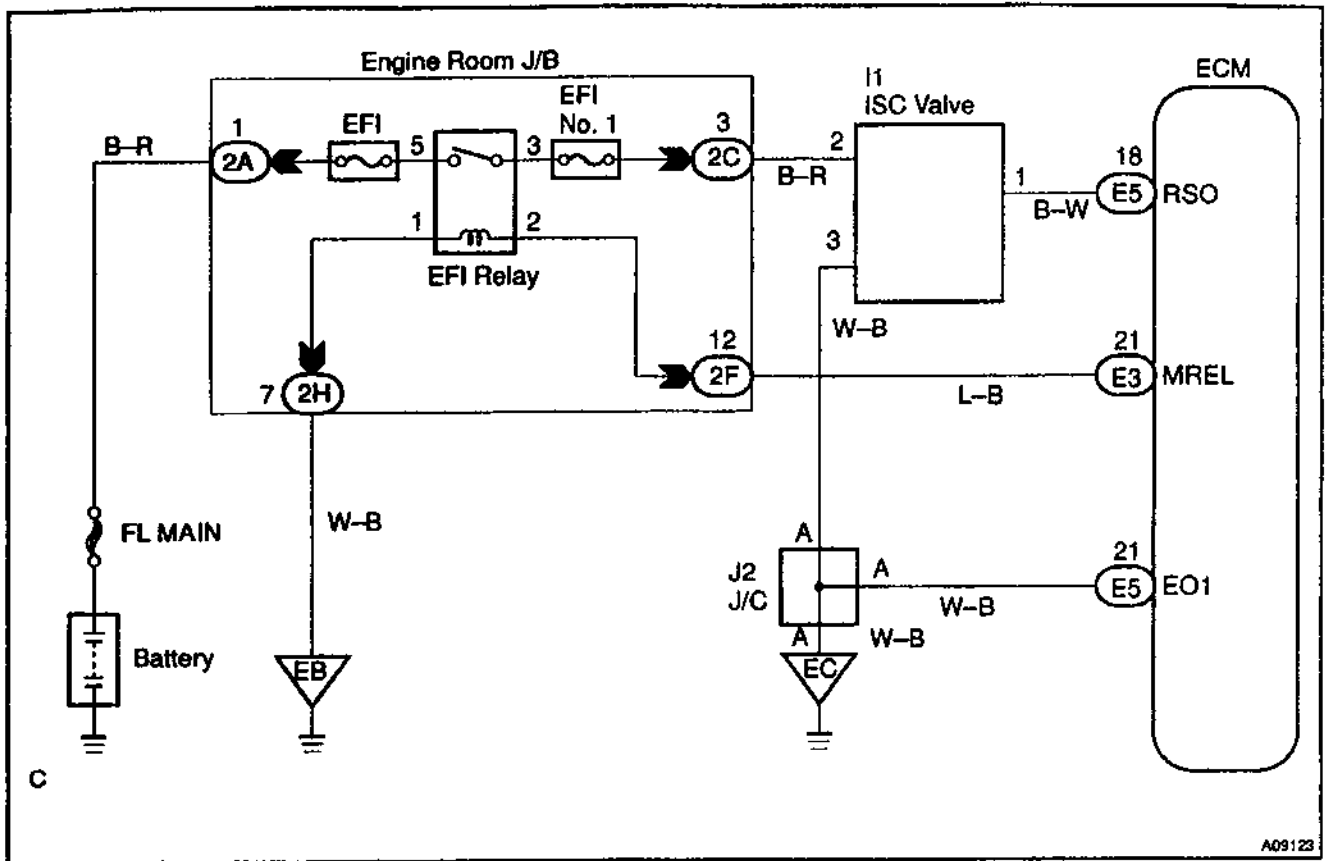

INSPECTION PROCEDURE

HINT:

Read freeze frame data using TOYOTA hand-held tester or OBD II scan tool. Because freeze frame records the engine conditions when the malfunction is detected, when troubleshooting it is useful for determining whether the vehicle was running or stopped, the engine warmed up or not, the air-fuel ratio lean or rich, etc. at the time of the malfunction.

1	Check engine idle speed.
----------	---------------------------------

PREPARATION:

- (a) Warm up engine to normal operating temperature.
- (b) Switch off all accessories.
- (c) Switch off airconditioning.
- (d) Shift transmission into "N" or neutral position.
- (e) Connect the OBD II scan tool or TOYOTA hand-held tester to DLC3 on the vehicle.
- (f) Using SST, connect terminals TE1 and E1 of the DLC1.

CHECK:

Check the difference of engine speed between the ones less than 5 sec. and more than 5 sec. after connecting terminals TE1 and E1 of the DLC1.

OK:

Difference of engine speed: More than 100 rpm.

OK

Go to step 6.

NG

2 Check voltage between terminals RSO, RSC of ECM connector and body ground.

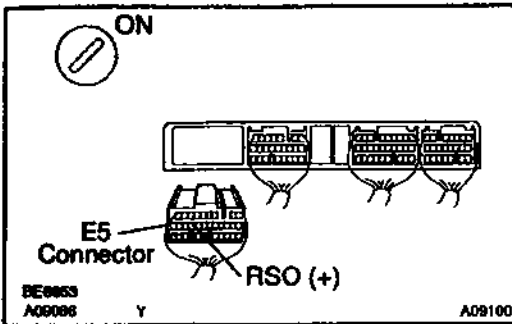

PREPARATION:

- Remove the ECM cover.
- Disconnect the E5 connector of ECM.
- Turn the ignition switch ON.

CHECK:

Measure voltage between terminals RSO of the ECM connector and body ground,

OK:

Voltage: 9 – 14 V

OK

Go to step 4.

NG

3 Check IAC valve (See page SF-40).

NG

Replace IAC valve.

OK

Check for open and short in harness and connector between engine room J/B No.2 and IAC valve and ECM (See page IN-30).

4 Check operation of the IAC valve (See page SF-40).

NG

Repair or replace IAC valve.

OK

5**Check the blockage of IAC valve and the passage to bypass the throttle valve.****NG****Repair or replace IAC valve.****OK****Check and replace ECM (See page IN-30).****6****Check for A/C signal circuit (See page AC-68).****NG****Repair or replace.****OK****Check air induction system
(See page SF-1).**

DTC	P1300	Igniter Circuit Malfunction (No.1)
------------	--------------	-------------------------------------------

DTC	P1305	Igniter Circuit Malfunction (No.2)
------------	--------------	-------------------------------------------

DTC	P1310	Igniter Circuit Malfunction (No.3)
------------	--------------	-------------------------------------------

DTC	P1315	Igniter Circuit Malfunction (No.4)
------------	--------------	-------------------------------------------

CIRCUIT DESCRIPTION

A DIS (Direct Ignition System) has been adopted. The DIS improves the ignition timing accuracy, reduces high-voltage loss, and enhances the overall reliability of the ignition system by eliminating the distributor. The DIS is a 1-cylinder ignition system which ignites one cylinder with one ignition coil. In the 1-cylinder ignition system, the one spark plug is connected to the end of the secondary winding. High voltage generated in the secondary winding is applied directly to the spark plug. The spark of the spark plug pass from the center electrode to the ground electrode.

The ECM determines ignition timing and outputs the ignition signals (IGT) for each cylinder. Based on IGT signals, the power transistors in the igniter cuts off the current to the primary coil in the ignition coil is supplied to the spark plug that are connected to the end of the secondary coil. At the same time, the igniter also sends an ignition confirmation signal (IGF) as a fail-safe measure to the ECM.

DTC No.	DTC Detecting Condition	Trouble Area
P1300 P1305 P1310 P1315	No IGF signal to ECM while engine is running	<ul style="list-style-type: none"> • Ignition system • Open or short in IGF1 and IGT1 - 4 circuit from ignition coil with igniter • No.1 ~ No.4 ignition coil with igniter • ECM

WIRING DIAGRAM

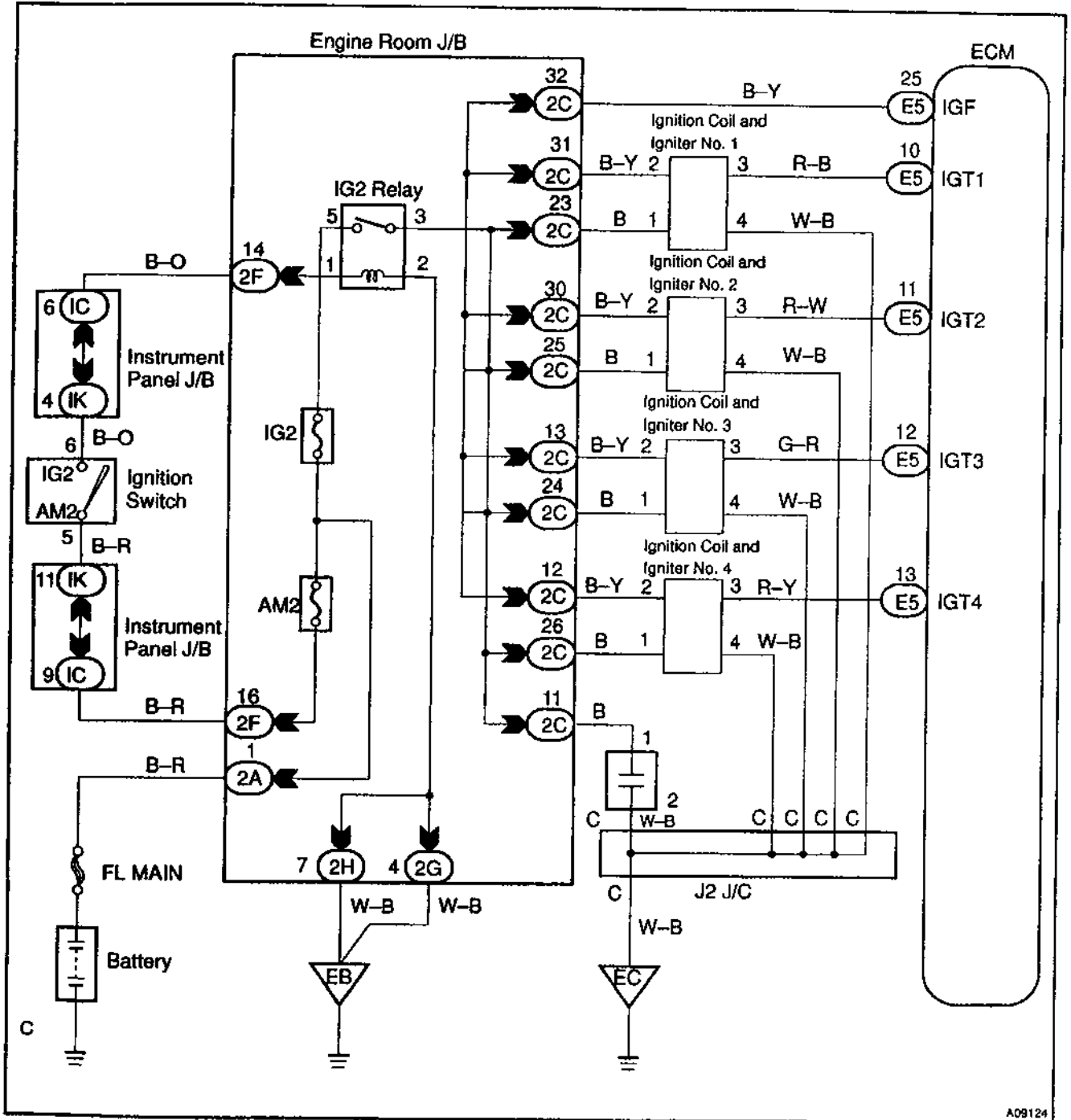

INSPECTION PROCEDURE

HINT:

- If DTC P1300 is displayed, check No.1 ignition coil with igniter circuit.
- If DTC P1305 is displayed, check No.2 ignition coil with igniter circuit.
- If DTC P1310 is displayed, check No.3 ignition coil with igniter circuit.
- If DTC P1315 is displayed, check No.4 ignition coil with igniter circuit.
- Read freeze frame data using TOYOTA hand-held tester or OBD II scan tool. Because freeze frame records the engine conditions when the malfunction is detected, when troubleshooting it is useful for determining whether the vehicle was running or stopped, the engine warmed up or not, the air-fuel ratio lean or rich, etc. at the time of the malfunction.

1 Check spark plug and spark (See page DI-64).

NG

Go to step 4.

OK

2 Check for open and short in harness and connector in IGF and IGT signal circuit between ECM and ignition coil with igniter (See page IN-30).

NG

Repair or replace harness or connector.

OK

3 Disconnect ignition coil with igniter connector and check voltage between terminals IGF of ECM connector and body ground.

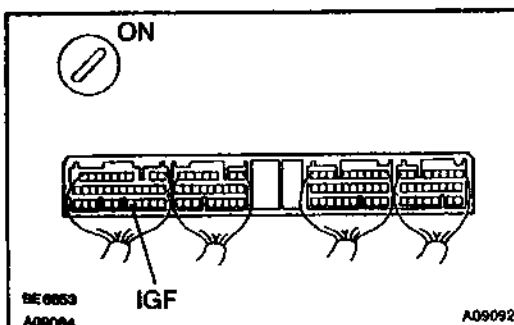

PREPARATION:

- Remove the ECM cover.
- Disconnect the ignition coil with igniter connector.
- Turn the ignition switch ON.

CHECK:

Measure voltage between terminals IGF of the ECM connector and body ground.

OK:

Voltage: 4.5 - 5.5 V

OK

Replace ignition coil with igniter.

NG

Check and replace ECM (See page IN-30).

4 Check for open and short in harness and connector in IGT signal circuit between ECM and ignition coil with igniter (See page IN-30).

NG **Repair or replace harness or connector.**

OK

5 Check voltage between terminals IGT1 - 4 of ECM connector and body ground.

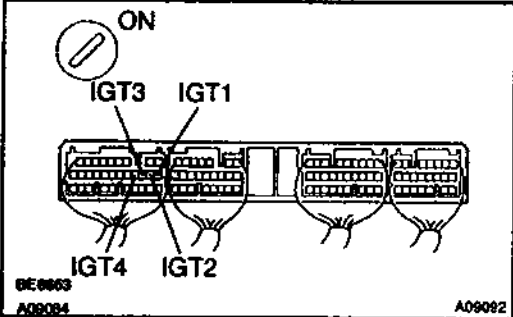

PREPARATION:
Remove the ECM cover.
CHECK:
Measure voltage between terminals IGT1 - 4 of the ECM connector and body ground when engine is cranked.
OK:
Voltage: More than 0.1 V and less than 4.5 V

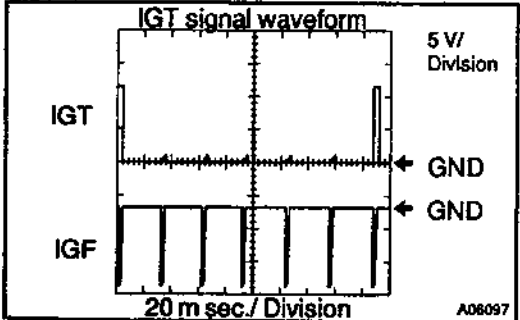

Reference: INSPECTION USING OSCILLOSCOPE
During cranking or idling, check waveform between terminals IGT1 - 4 and E1 of the ECM connector.
HINT:
Correct waveform appears as shown, with rectangle waves.

NG **Check and replace ECM (See page IN-30).**

OK

- 6 Disconnect ignition coil with igniter connector and check voltage between terminals IGT1 - 4 of ECM connector and body ground.**

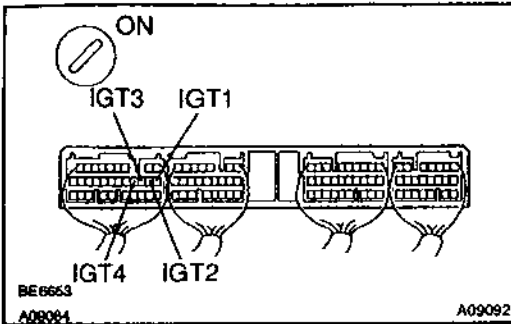
**PREPARATION:**

- (a) Remove the ECM cover.
 (b) Disconnect the ignition coil with igniter connector.

CHECK:

Measure voltage between terminals IGT1 - 4 of the ECM connector and body ground when engine is cranked.

OK:

Voltage: More than 0.1 V and less than 4.5 V

NG

Check and replace ECM (See page IN-30).

OK

- 7 Check ignition coil with igniter power source circuit.**

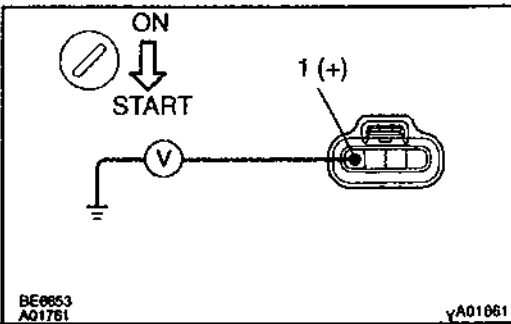
**PREPARATION:**

Disconnect the ignition coil with igniter connector.

CHECK:

Measure voltage between terminal 1 of ignition coil with igniter connector and body ground, when ignition switch is turned to "ON" and "START" position.

OK:

Voltage: 9 - 14 V

NG

Repair ignition coil with igniter power source-circuit.

OK

- 8 Check for open and short in harness and connector between ignition switch and ignition coil with igniter (See page IN-30).**

NG

Repair or replace harness or connector.

OK

9 Check EFI main relay (Marking: EFI) (See page SF-52).

NG Replace EFI main relay (marking: EFI).

OK

Replace ignition coil with igniter.

DTC	P1335	Crankshaft Position Sensor Circuit Malfunction (During engine running)
------------	--------------	-------------------------------------------------------------------------------

CIRCUIT DESCRIPTION

Refer to DTC P0335 (Crankshaft Position "A" Circuit Malfunction) on page DI-74.

DTC No.	DTC Detecting Condition	Trouble Area
P1335	If conditions (a) through (c) are met: (a) NE \geq 1,000 rpm (b) NE signal is not detected for over 50 m sec. (c) Not during cranking	<ul style="list-style-type: none"> • Open or short in crankshaft position sensor circuit • Crankshaft position sensor • Signal plate • ECM

WIRING DIAGRAM

Refer to DTC P0335 on page DI-74.

INSPECTION PROCEDURE

Refer to DTC P0335 on page DI-74.

DTC	P1346	VVT Sensor (Camshaft Position Sensor) Circuit Range/Performance Problem
------------	--------------	--------------------------------------------------------------------------------

CIRCUIT DESCRIPTION

VVT sensor (VV1 or VV2 signal) consist of a signal plate and pickup coil.

The VV1 or VV2 signal plate has 1 tooth on its outer circumference and is mounted on the intake camshafts. When the camshafts rotate, the protrusion on the signal plate and the air gap on the pickup coil change, causing fluctuations in the magnetic field and generating an electromotive force in the pickup coil.

The actual camshaft angle is detected by the VVT sensor and it provides feedback to the ECM to control the intake valve timing in response to during condition.

DTC No.	Detection Item	Trouble Area
P1346	Deviation in crankshaft position sensor signal and VVT sensor (bank 1) signal (2 trip detection logic)	<ul style="list-style-type: none"> • Mechanical system malfunction (Skipping teeth of timing belt, belt stretched) • ECM

WIRING DIAGRAM

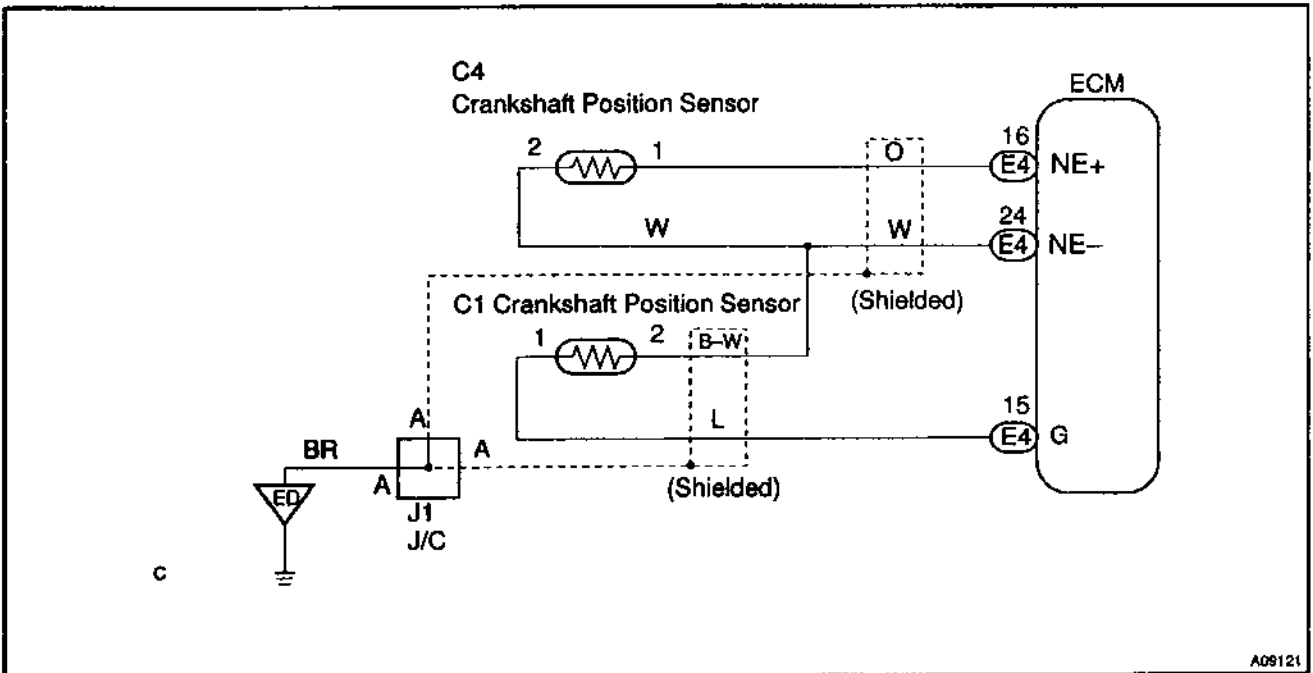

INSPECTION PROCEDURE**HINT:**

Read freeze frame data using TOYOTA hand-held tester or OBD II scan tool. Because freeze frame records the engine conditions when the malfunction is detected, when troubleshooting it is useful for determining whether the vehicle was running or stopped, the engine warmed up or not, the air-fuel ratio lean or rich, etc. at the time of the malfunction.

1

**Check valve timing (Check for loose and jumping teeth of timing belt)
(See page EM-18).**

NG

Adjust valve timing (Repair or replace timing belt).

OK

Check and replace ECM (See page IN-30).

DTC	P1349	VVT System Malfunction
------------	--------------	-------------------------------

CIRCUIT DESCRIPTION

VVT system controls the intake valve timing to proper timing in response to driving condition. ECM controls OCV (Oil Control Valve) to make the intake valve timing properly, and, oil pressure controlled with OCV is supplied to the VVT controller, and then, VVT controller changes relative position between the camshaft and the crankshaft.

DTC No.	DTC Detecting Condition	Trouble Area
P1349	Condition (a) or (b) continues for after the engine is warmed up and engine speed at 400 - 4,000 rpm : (a) Valve timing does not change from of current valve timing (b) Current valve timing is fixed.	<ul style="list-style-type: none"> • Valve timing • Oil control valve • VVT controller assembly • ECM

WIRING DIAGRAM

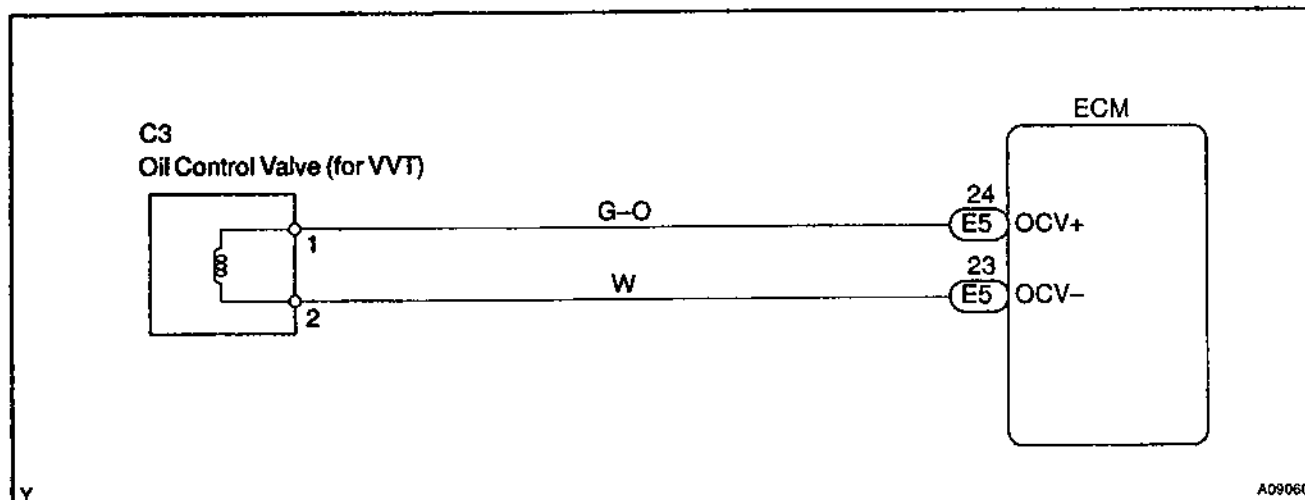

Y

INSPECTION PROCEDURE**HINT:**

- If DTC P1349 is displayed, check left bank VVT system circuit.
- Read freeze frame data using TOYOTA hand-held tester or OBD II scan tool. Because freeze frame records the engine conditions when the malfunction is detected, when troubleshooting it is useful for determining whether the vehicle was running or stopped, the engine warmed up or not, the air-fuel ratio lean or rich, etc. at the time of the malfunction.

TOYOTA hand-held tester

1	Check valve timing (See page EM-18).
----------	---------------------------------------------

NG	Repair valve timing.
-----------	-----------------------------

OK

2	Check operation of OCV.
----------	--------------------------------

PREPARATION:

- Start the engine and warmed it up.
- Connect the TOYOTA hand-held tester and select VVT from ACTIVE TEST menu.

CHECK:

Check the engine speed when operate the OCV by the TOYOTA hand-held tester.

OK:

OCV is OFF:

Normal engine speed

OCV is ON:

Rough idle or engine stall

OK	VVT system is OK.*
-----------	---------------------------

*: DTC P1349 is also output after the foreign object is caught in some part of the system in the engine oil and the system returns to normal in a short time. As ECM controls so that foreign objects are ejected, there is no problem about VVT. There is also no problem since the oil filter should get the foreign object in the engine oil.

NG

3 Check voltage between terminals OCV+ and OCV- of ECM connector.

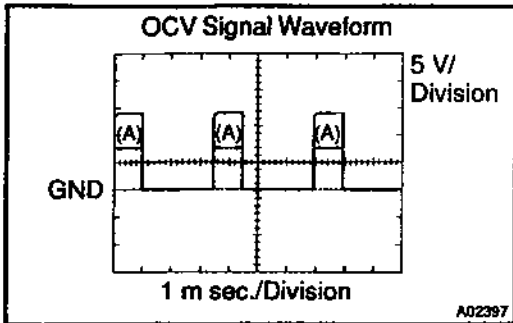

Reference: INSPECTION USING OSCILLOSCOPE

Turn the ignition switch ON, check waveform between terminals OCV+ and OCV- of the ECM connector.

HINT:

- The correct waveform is as shown.
- The waveform frequency (A) is lengthened as the engine speed becomes higher.

NG Check and replace ECM (See page IN-30).

OK

4 Check VVT controller assembly (See page EM-48).

NG Replace VVT controller assembly, and then go to step 5.

OK

5 Check oil control valve (See page SF-50).

NG Replace oil control valve, and then go to step 6.

OK

6 Check blockage of oil control valve, oil check valve and oil pipe No.1.

NG Repair or replace.

OK

7	Check whether or not DTC P1349 is stored.
----------	--------------------------------------------------

PREPARATION:

- (a) Clear the DTC (See page DI-3).
- (b) Perform simulation test.

CHECK:

Check whether or not DTC P1349/P1354 is stored (See page DI-3).

OK:

DTC P1349 is not stored

OK	VVT system is OK.*
-----------	---------------------------

*: DTC P1349 is also output after the foreign object is caught in some part of the system in the engine oil and the system returns to normal in a short time. As ECM controls so that foreign objects are ejected, there is no problem about VVT. There is also no problem since the oil filter should get the foreign object in the engine oil.

NG

Replace ECM.

OBD II scan tool (excluding TOYOTA hand-held tester)

1	Check valve timing (See page EM-18).
----------	---------------------------------------------

NG	Repair valve timing.
-----------	-----------------------------

OK

2 Check operation of OCV.

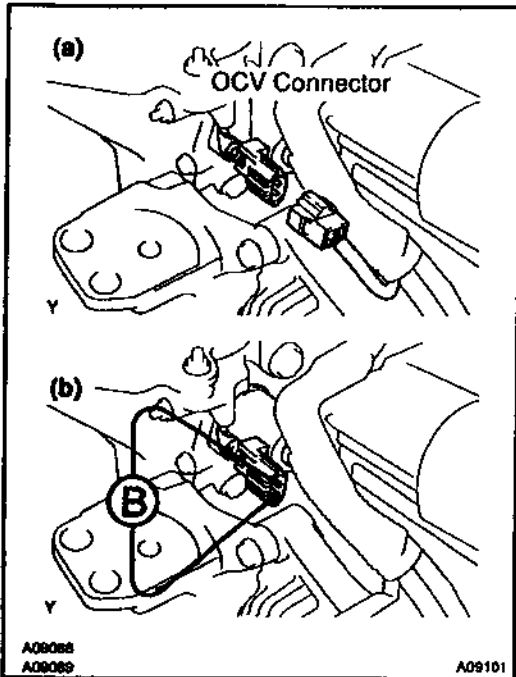

PREPARATION:

Start the engine.

CHECK:

- (a) Check the engine speed when disconnect the OCV connector.
- (b) Check the engine speed when apply battery positive voltage between terminals of OCV.

RESULT:

Result	Check (a)	Check (b)
1	Normal engine speed	Rough idle or engine stall
2	Except 1	

2 Go to step 4.

1

3 Check voltage between terminals OCV+ and OCV- of ECM connector.

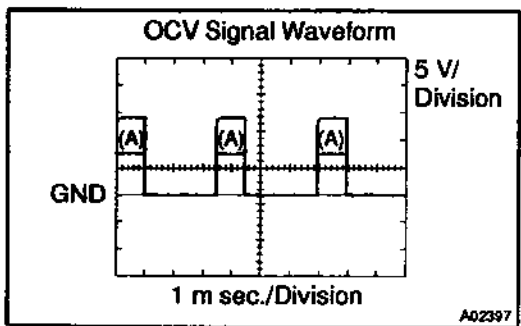

Reference: INSPECTION USING OSCILLOSCOPE

Turn the ignition switch ON, check waveform between terminals OCV+ and OCV- of the ECM connector.

HINT:

- The correct waveform is as shown.
- The waveform frequency (A) is lengthened as the engine speed becomes higher.

OK VVT system is OK.*

*: DTC P1349 is also output after the foreign object is caught in some part of the system in the engine oil and the system returns to normal in a short time. As ECM controls so that foreign objects are ejected, there is no problem about VVT. There is also no problem since the oil filter should get the foreign object in the engine oil.

NG

Check and replace ECM (See page IN-30).

4 Check VVT controller assembly (See page EM-48).

NG

Replace VVT controller assembly, and then go to step 5.

OK

5 Check oil control valve (See page SF-50).

NG

Replace oil control valve, and then go to step 6.

OK

6 Check blockage of oil control valve, oil check valve and oil pipe No.1.

NG

Repair or replace.

OK

7 Check whether or not DTC P1349 is stored.

PREPARATION:

- (a) Clear the DTC (See page DI-3).
- (b) Perform simulation test.

CHECK:

Check whether or not DTC P1349/P1354 is stored (See page DI-3).

OK:

DTC P1349 is not stored

OK

VVT system is OK.*

*: DTC P1349 is also output after the foreign object is caught in some part of the system in the engine oil and the system returns to normal in a short time. As ECM controls so that foreign objects are ejected, there is no problem about VVT. There is also no problem since the oil filter should get the foreign object in the engine oil.

NG

Replace ECM.

DTC	P1520	Stop Light Switch Signal Malfunction (Only for A/T)
------------	--------------	----------------------------------------------------------------

CIRCUIT DESCRIPTION

This signal is used to detect when the brakes have been applied. The STP signal voltage is the same as the voltage supplied to the stop lights.

The STP signal is used mainly to control the fuel cut-off engine speed. (The fuel cut-off engine speed is reduced slightly when the vehicle is braking.)

DTC No.	DTC Detecting Condition	Trouble Area
P1520	The stop light switch does not turn off even once the vehicle is driven (2 trip detection logic)	<ul style="list-style-type: none"> • Short in stop light switch signal circuit • Stop light switch • ECM

WIRING DIAGRAM

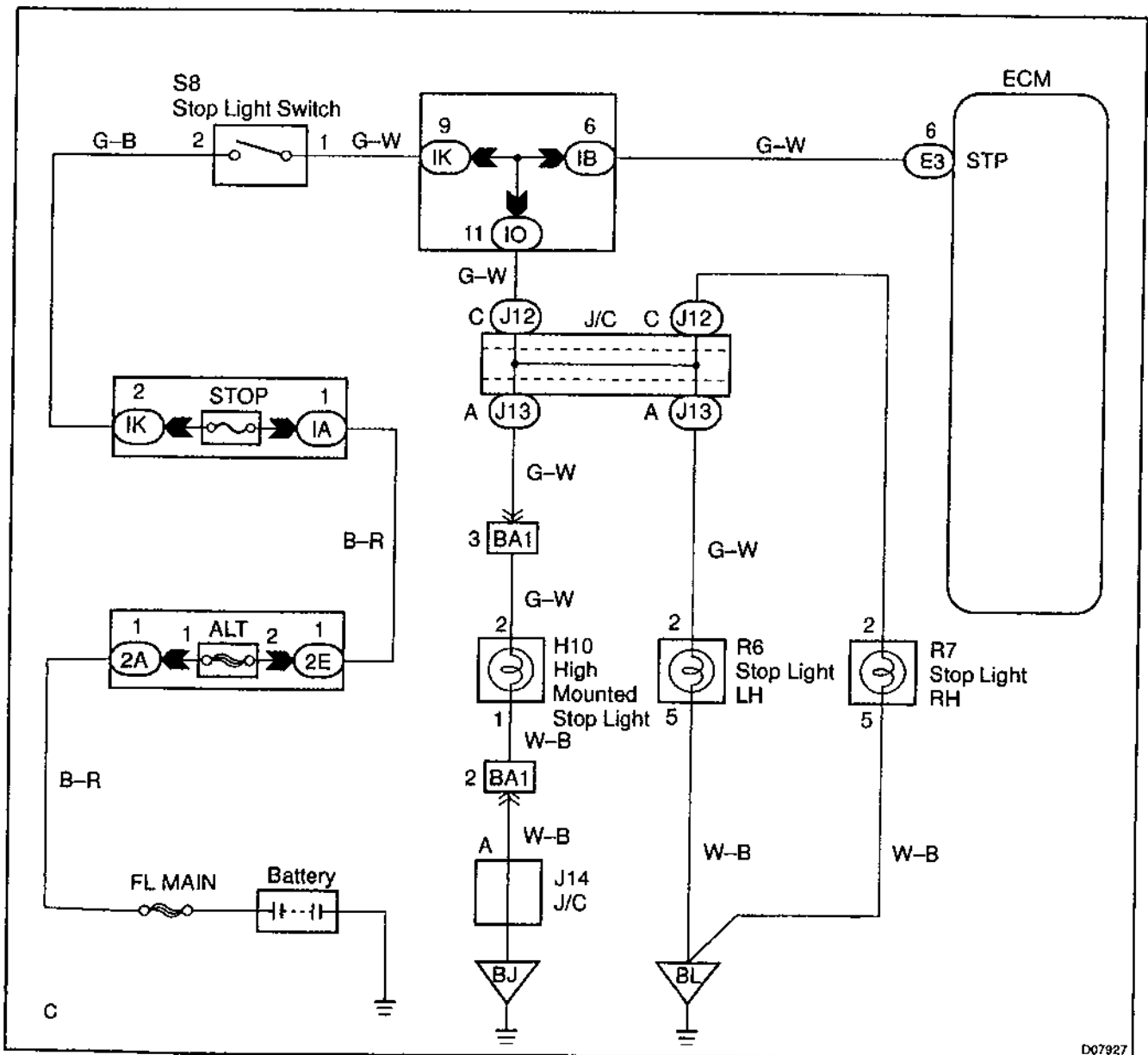

INSPECTION PROCEDURE

HINT:

Read freeze frame data using TOYOTA hand-held tester or OBD II scan tool. Because freeze frame records the engine conditions when the malfunction is detected, when troubleshooting it is useful for determining whether the vehicle was running or stopped, the engine warmed up or not, the air-fuel ratio lean or rich, etc. at the time of the malfunction.

1 Check operation of stop light.

PREPARATION:

Check if the stop lights go on and off normally when the brake pedal is operated and released.

NG Check and repair stop light circuit (See page BE-33).

OK

2 Check STP signal.

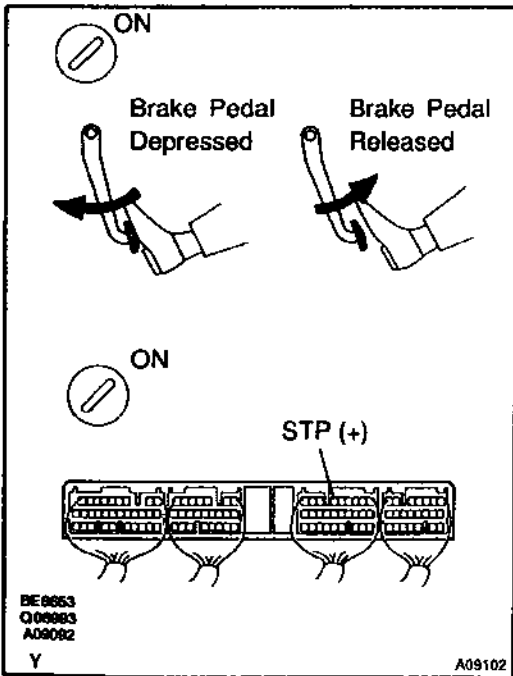

When using TOYOTA hand-held tester:

PREPARATION:

- (a) Connect the to the DLC3.
- (b) Turn the ignition switch ON and TOYOTA hand-held tester main switch ON.

CHECK:

Read the STP signal on the TOYOTA hand-held tester.

OK:

- Brake pedal is depressed: STP ... ON
- Brake pedal is released: STP ... OFF

When not using TOYOTA hand-held tester:

PREPARATION:

Turn the ignition switch ON.

CHECK:

Check voltage between terminal STP of ECM and body ground.

OK:

Brake pedal	Voltage
Depressed	7.5 - 14 V
Released	Below 1.5 V

OK Check for Intermittent problems (See page DI-3).

NG

3	Check harness and connector between ECM and stop light switch (See page IN-30).
----------	----------------------------------------------------------------------------------------

NG

Repair or replace harness or connector.

OK

Check and replace ECM (See page IN-30).

DTC	P1600	ECM BATT Malfunction
------------	--------------	-----------------------------

CIRCUIT DESCRIPTION

Battery positive voltage is supplied to terminal BATT of the ECM even when the ignition switch is OFF for use by the DTC memory and air-fuel ratio adaptive control value memory, etc.

DTC No.	DTC Detecting Condition	Trouble Area
P1600	Open in back up power source circuit	<ul style="list-style-type: none"> • Open in back up power source circuit • ECM

HINT:

If DTC P1600 appear, the ECM does not store another DTC.

WIRING DIAGRAM

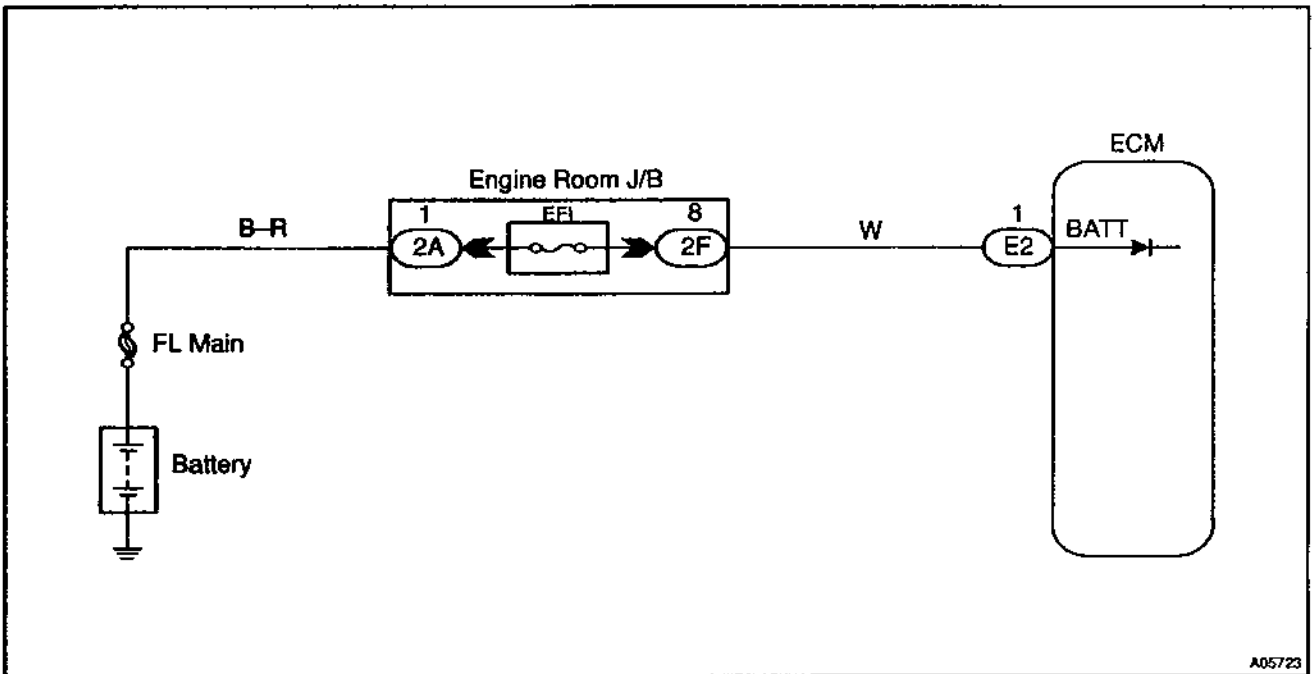

INSPECTION PROCEDURE

HINT:

Read freeze frame data using TOYOTA hand-held tester or OBD II scan tool. Because freeze frame records the engine conditions when the malfunction is detected, when troubleshooting it is useful for determining whether the vehicle was running or stopped, the engine warmed up or not, the air-fuel ratio lean or rich, etc. at the time of the malfunction.

1 Check voltage between terminal BATT of ECM connector and body ground.

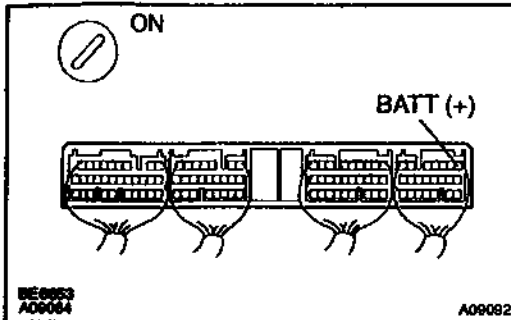
**PREPARATION:**

Remove the ECM cover.

CHECK:

Measure voltage between terminal BATT of the ECM connector and body ground.

OK:

Voltage 9 – 14 V

OK

Check and replace ECM (See page IN-30).

NG

2 Check EFI fuse.

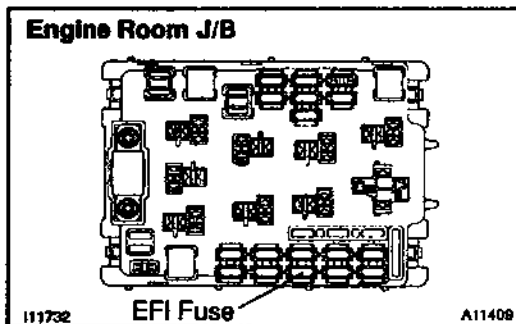
**PREPARATION:**

Remove the EFI fuse from the engine room J/B.

CHECK:

Check continuity of EFI fuse.

OK:

Continuity

NG

Check for short in all the harness and components connected to EFI fuse.

OK

Check and repair harness or connector between battery and EFI fuse and ECM (See page IN-30).

DTC	P1645	Body ECU Malfunction
------------	--------------	-----------------------------

CIRCUIT DESCRIPTION

ECM receives the operating condition (ON/OFF) of A/C from A/C ECU and it also receives the electrical load information from the body ECU.

ECM uses these information to control the engine (idle up, etc.).

DTC No.	DTC Detecting Condition	Trouble Area
P1645	Condition (a) or (b) continues for 3.0 sec. (a) No communication from body ECU (b) No communication from A/C ECU	<ul style="list-style-type: none"> • Body ECU • A/C ECU • Communication bus

INSPECTION PROCEDURE

HINT:

Read freeze frame data using TOYOTA hand-held tester or OBD II scan tool. Because freeze frame records the engine conditions when the malfunction is detected, when troubleshooting it is useful for determining whether the vehicle was running or stopped, the engine warmed up or not, the air-fuel ratio lean or rich, etc. at the time of the malfunction.

Perform troubleshooting the Multiplex Communication System (See page DI-600).

DTC	P1656	OCV Circuit Malfunction
------------	--------------	--------------------------------

CIRCUIT DESCRIPTION

Refer to DTC P1349 (VVT System Malfunction) on page DI-123.

DTC No.	DTC Detecting Condition	Trouble Area
P1656 P1663	Open or short in oil control valve circuit	<ul style="list-style-type: none"> • Open or short in oil control valve circuit • Oil control valve • ECM

WIRING DIAGRAM

Refer to DTC P1349 (VVT System Malfunction) on page DI-123 for the WIRING DIAGRAM.

INSPECTION PROCEDURE

HINT:

Read freeze frame data using TOYOTA hand-held tester or OBD II scan tool. Because freeze frame records the engine conditions when the malfunction is detected, when troubleshooting it is useful for determining whether the vehicle was running or stopped, the engine warmed up or not, the air-fuel ratio lean or rich, etc. at the time of the malfunction.

TOYOTA hand-held tester

1	Check OCV circuit.
----------	---------------------------

PREPARATION:

- (a) Start the engine and warmed it up.
- (b) Connect the TOYOTA hand-held tester and select VVT from ACTIVE TEST menu.

CHECK:

Check the engine speed when operate the OCV by the TOYOTA hand-held tester.

OK:

VVT system is OFF (OCV is OFF):
Normal engine speed
VVT system is ON (OCV is ON):
Rough idle or engine stalled

OK

**Check for intermittent problems
 (See page DI-3).**

NG

2 Check operation of OCV.

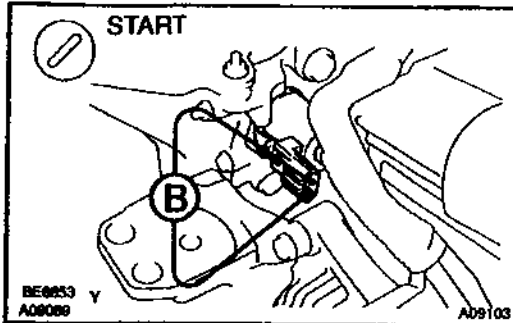

PREPARATION:

- Start the engine and warmed it up.
- Disconnect the OCV connector.
- Apply battery positive voltage between terminals of the OCV.

CHECK:

Check the engine speed.

OK:

Rough Idle or engine stalled.

NG

Replace OCV.

OK

**3 Check voltage between terminals OCV+ and OCV- of ECM connector
(See page DI-123).**

NG

Check and replace ECM (See page IN-30).

OK

**4 Check for open and short in harness and connector between OCV and ECM
(See page IN-30).**

NG

Repair or replace.

OK

Check for Intermittent problems
(See page DI-3).

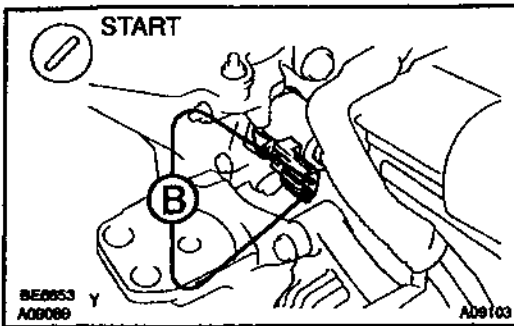
OBD II scan tool (excluding TOYOTA hand-held tester)**1 Check operation of OCV.****PREPARATION:**

- (a) Start the engine and warmed it up.
- (b) Disconnect the OCV connector.
- (c) Apply battery positive voltage between terminals of the OCV.

CHECK:

Check the engine speed.

OK:

Rough Idle or engine stalled

NG

Replace OCV.

OK

2 Check voltage between terminals OCV+ and OCV- of ECM connector (See page DI-123).

NG

Check and replace ECM (See page IN-30).

OK

3 Check for open and short in harness and connector between OCV and ECM (See page IN-30).

NG

Repair or replace.

OK

Check for Intermittent problems
(See page DI-3).

DTC	P1690	OCV for VVTL Circuit Malfunction
------------	--------------	-----------------------------------------

CIRCUIT DESCRIPTION

When the engine speed reaches 6,000b rpm, the VVTL system switches the locker arm from low speed to high speed. The ECM control the OCV to apply hydraulic pressure to the piston in the locker arm and switch the locker arm by locking the slipper for high speed.

DTC No.	DTC Detecting Condition	Trouble Area
P1690	Open or short in oil control valve for VVTL circuit	<ul style="list-style-type: none"> • Open or short in oil control valve circuit • Oil control valve (for VVTL) • ECM

WIRING DIAGRAM

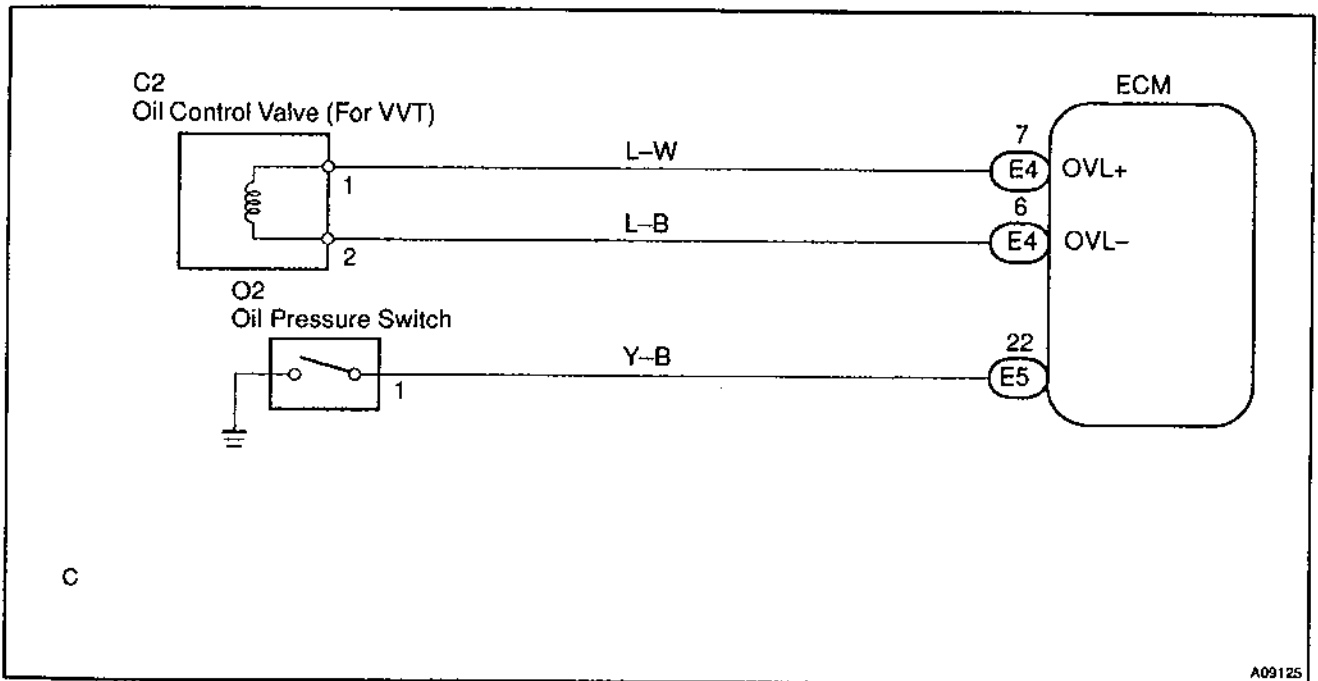

INSPECTION PROCEDURE

HINT:

Read freeze frame data using TOYOTA hand-held tester or OBD II scan tool. Because freeze frame records the engine conditions when the malfunction is detected, when troubleshooting it is useful for determining whether the vehicle was running or stopped, the engine warmed up or not, the air-fuel ratio lean or rich, etc. at the time of the malfunction.

TOYOTA hand-held tester

1	Check OCV for VVTL circuit.
----------	------------------------------------

PREPARATION:

- (a) Start the engine and warmed it up.
- (b) Connect the TOYOTA hand-held tester and select VVTL from ACTIVE TEST menu.
- (c) Maintain engine speed at 1,500 – 2,500 rpm.

CHECK:

Check the engine speed when operate the OCV by the TOYOTA hand-held tester.

OK:

VVTL system is OFF (OCV is OFF):

Normal engine speed

VVTL system is ON (OCV is ON):

Rough engine speed or engine stalled

OK

Check for Intermittent problems (See page DI-3).

NG

2	Check operation of OCV for VVTL.
----------	-----------------------------------------

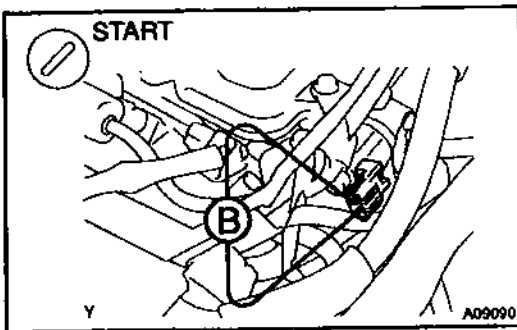
**PREPARATION:**

- (a) Start the engine and warmed it up.
- (b) Disconnect the OCV for VVTL connector.
- (c) Maintain engine speed at 1,500 – 2,500 rpm.
- (d) Apply battery positive voltage between terminals of the OCV.

CHECK:

Check the engine speed.

OK:

Engine stalled.

NG

Replace OCV for VVTL.

OK

- 3** Check for open and short in harness and connector between OCV for VVTL and ECM (See page IN-30).

NG Repair or replace.

OK

Check and replace ECM (See page IN-30).

OBD II scan tool (excluding TOYOTA hand-held tester)

- 1** Check operation of OCV for VVTL.

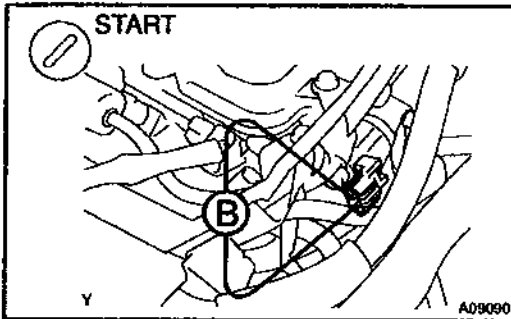

PREPARATION:

- Start the engine and warmed it up.
- Disconnect the OCV connector.
- Maintain engine speed at 1,500 – 2,500 rpm.
- Apply battery positive voltage between terminals of the OCV.

CHECK:

Check the engine speed.

OK:

Rough engine speed or engine stalled

NG Replace OCV for VVTL.

OK

- 2** Check voltage between terminals OVL+ and OVL- of ECM connector (See page DI-20).

NG Check and replace ECM (See page IN-30).

OK

3	Check for open and short in harness and connector between OCV for VVTL and ECM (See page IN-30).
----------	---------------------------------------------------------------------------------------------------------

NG

Repair or replace.

OK

Check and replace ECM (See page IN-30).

DTC	P1692	OCV for VVTL Open Malfunction
------------	--------------	--------------------------------------

DTC	P1693	OCV for VVTL Close Malfunction
------------	--------------	---------------------------------------

CIRCUIT DESCRIPTION

Refer to DTC P1690 (OCV for VVTL Circuit Malfunction) on page DI-139.

DTC No.	DTC Detecting Condition	Trouble Area
P1692	In the condition that the engine speed is 6,000 rpm or less and the oil pressure switch on for 5 sec. or more.	<ul style="list-style-type: none"> • Open or short in oil control valve circuit • Oil control valve (for VVTL) • ECM
P1693	In the condition that the water temperature is 60 °C or more, the engine speed is 6,000 rpm or more, and the oil pressure switch OFF for 1 sec. or more.	

WIRING DIAGRAM

Refer to DTC P1690 (OCV for VVTL Circuit Malfunction) on page DI-139.

INSPECTION PROCEDURE

1	Check oil pressure switch for VVTL (See page LU-1).
----------	------------------------------------------------------------

NG

Reprace oil pressure switch.

OK

2	Check for open and short in harness and connector between oil pressure switch for VVTL and ECM (See page IN-30).
----------	-------------------------------------------------------------------------------------------------------------------------

NG

Repair or replace.

OK

3	Check oil pressure for VVTL (See page LU-1).
----------	-----------------------------------------------------

OK

Check and replace ECM (See page IN-30).

NG

4 Check OCV for VVTL (See page SF-50) and oil filter.

NG Repair or replace OCV or filter.

OK

5 Check for open and short in harness and connector between OCV for VVTL and ECM (See page IN-30).

NG Repair or replace.

OK

Check and replace ECM (See page IN-30).

DTC	P1780	Park/Neutral Position Switch Malfunction (Only for A/T)
------------	--------------	--------------------------------------------------------------------

CIRCUIT DESCRIPTION

The park/neutral position switch goes on when the shift lever is in the N or P shift position. When it goes on terminal NSW of the ECM is grounded to body ground via the starter relay thus the terminal NSW voltage becomes 0V. When the shift lever is in the D, 2, L, or R position, the park/neutral position switch goes off, so the voltage of ECM Terminal NSW becomes battery positive voltage, the voltage of the ECM internal power source.

If the shift lever is moved from the N position to the D position, this signal is used for air-fuel ratio correction and for idle speed control (estimated control), etc.

DTC No.	DTC Detecting Condition	Trouble Area
P1780	2 or more switches are ON simultaneously for "N", "2", "L" and "R" position (2 trip detection logic)	<ul style="list-style-type: none"> • Short in park/neutral position switch circuit • Park/neutral position switch • ECM
	When driving under conditions (a) and (b) for 30 sec. or more the park/neutral position switch is ON (N position): (2 trip detection logic) (a) Vehicle speed: 80 km/h (50 mph) or more (b) Engine speed: 2,000 - 5,000 rpm	

HINT:

After confirming DTC P1780, use the TOYOTA hand-held tester to confirm the PNP switch signal from "CURRENT DATA".

WIRING DIAGRAM

Refer to DTC P1780 on page U240E:DI-202, U341E:DI-261 for the WIRING DIAGRAM.

INSPECTION PROCEDURE

HINT:

Read freeze frame data using TOYOTA hand-held tester or OBD II scan tool. Because freeze frame records the engine conditions when the malfunction is detected, when troubleshooting it is useful for determining whether the vehicle was running or stopped, the engine warmed up or not, the air-fuel ratio lean or rich, etc. at the time of the malfunction.

Refer to DTC P1780 on U240E:DI-202, U341E:DI-261 for the INSPECTION PROCEDURE.

ECM Power Source Circuit

CIRCUIT DESCRIPTION

When the ignition switch is turned ON, battery positive voltage is applied to the coil, closing the contacts of the EFI main relay (Making: EFI) and supplying power to the terminal +B of the ECM.

WIRING DIAGRAM

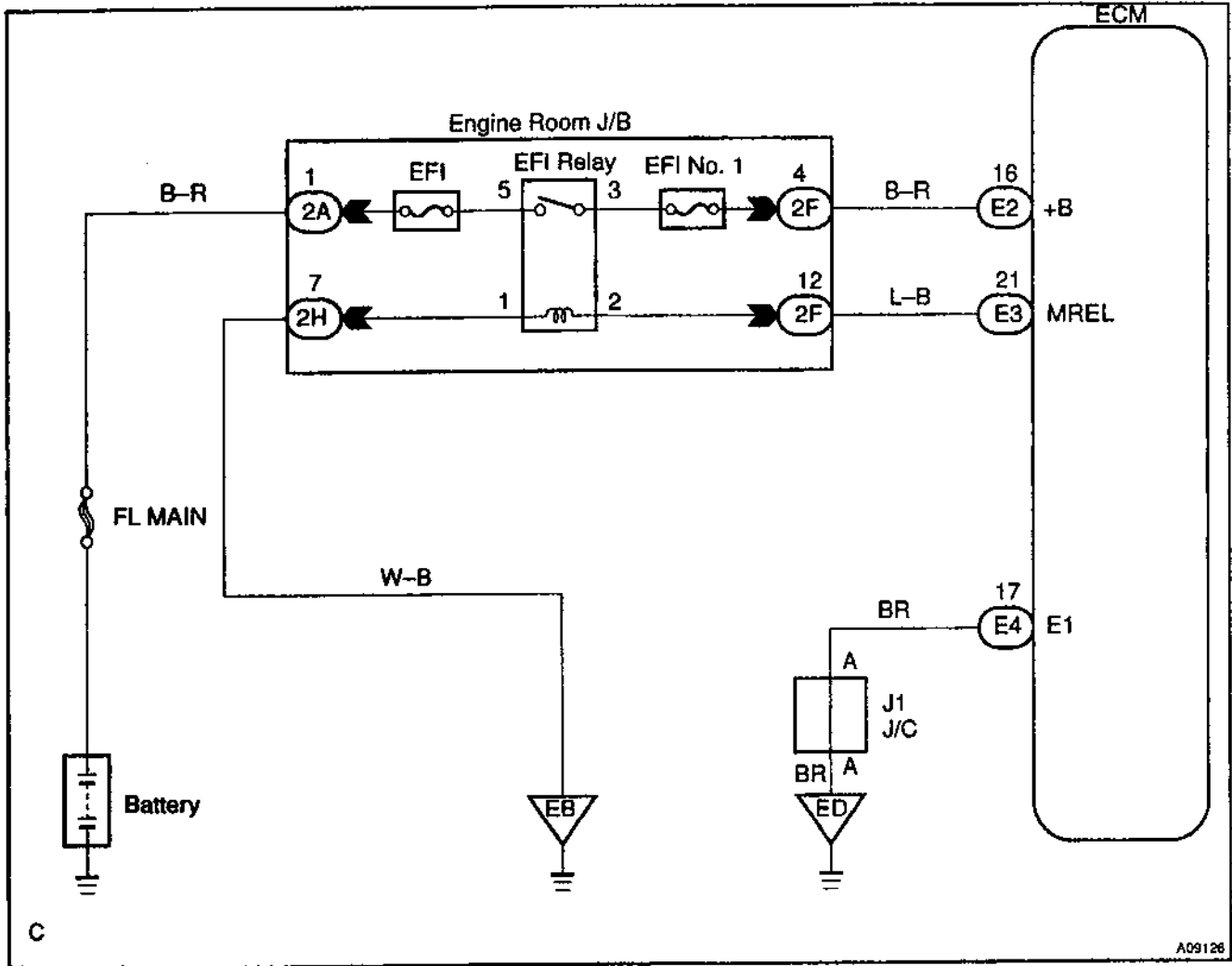

C

A09128

INSPECTION PROCEDURE

- 1 Check voltage between terminals + B and E1 of ECM connector.

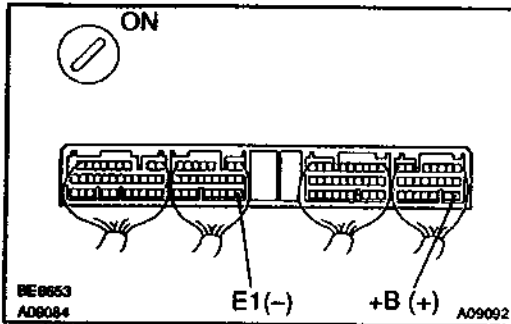
**PREPARATION:**

- (a) Remove the ECM cover.
(b) Turn the ignition switch ON.

CHECK:

Measure voltage between terminals + B and E1 of the ECM connector.

OK:

Voltage: 9 - 14 V

OK

Proceed to next circuit inspection shown on Problem symptoms table (See page DI-22).

NG

- 2 Check for open in harness and connector between terminal E1 of ECM and body ground (See page IN-30).

NG

Repair or replace harness or connector.

OK

- 3 Check EFI main relay (Marking: EFI) (See page SF-52).

NG

Replace EFI main relay.

OK

- 4 Check EFI fuse (See page DI-133).

NG

Check for short in all the harness and components connected to EFI fuse.

OK

5 Check for open in harness and connector between EFI main relay (Marking: EFI) and battery, EFI main relay (Marking: EFI) and ECM (See page IN-30).

NG Repair or replace harness or connector.

OK

6 Check EFI No. 1 fuse.

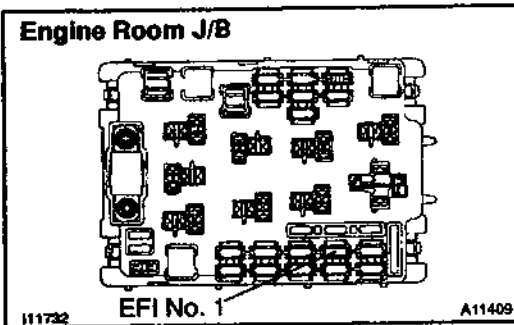

PREPARATION:

Remove IGN fuse from engine room J/B.

CHECK:

Check continuity of EFI No. 1 fuse.

OK:

Continuity

NG Check for short in all the harness and components connected to EFI No. 1 fuse.

OK

7 Check ignition switch (See page BE-14).

NG Replace ignition switch.

OK

Check for open in harness and connector between IG switch and EFI main relay and body ground (See page IN-30).

Fuel Pump Control Circuit

CIRCUIT DESCRIPTION

In the diagram below, when the engine is cranked, current flows from terminal ST of the ignition switch to the starter relay coil and also current flows to terminal STA of ECM (STA signal).

When the STA signal and NE signal are input to the ECM, Tr is turned ON, current flows to coil of the circuit opening relay, the relay switches on, power is supplied to the fuel pump and the fuel pump operates.

While the NE signal is generated (engine running), the ECM keeps Tr ON (circuit opening relay ON) and the fuel pump also keeps operating.

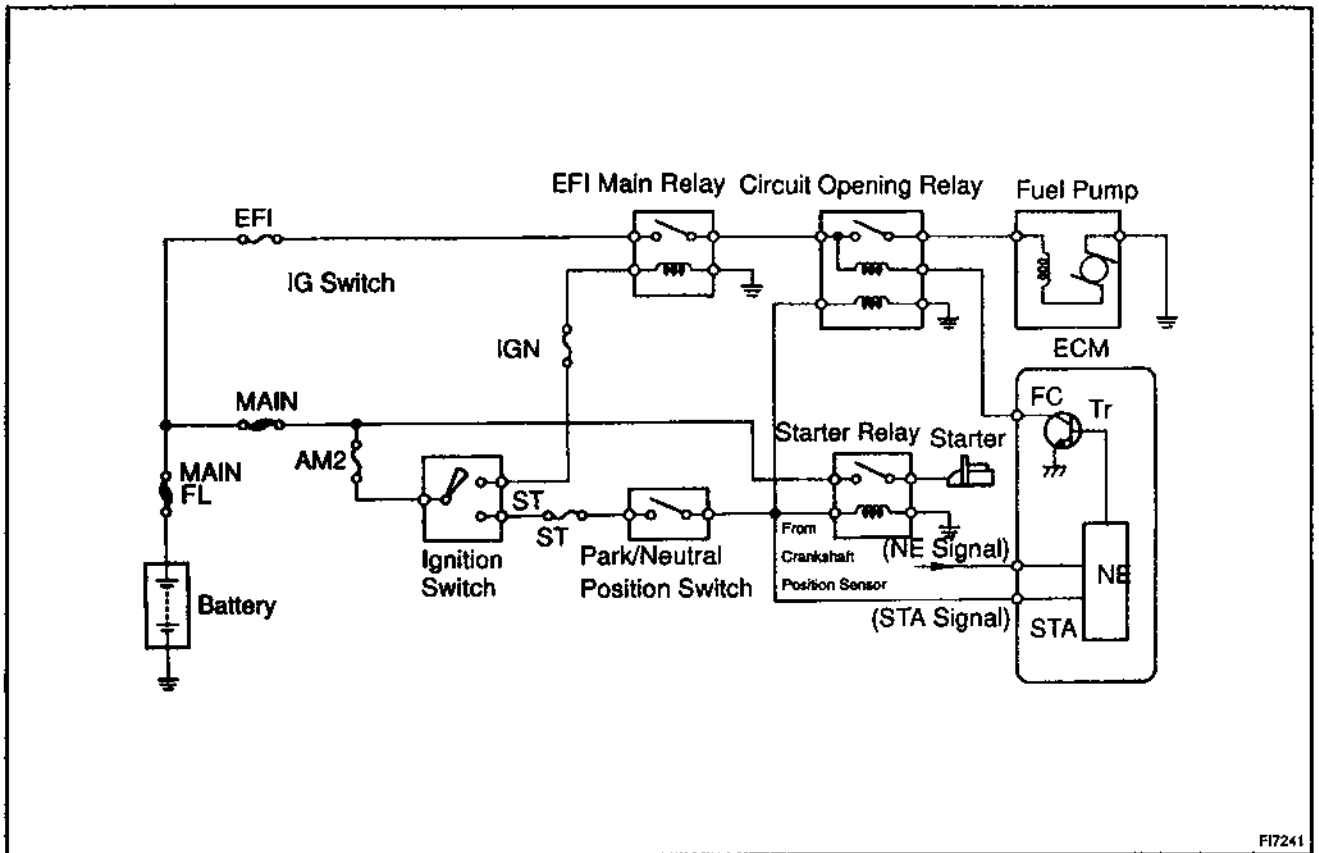

WIRING DIAGRAM

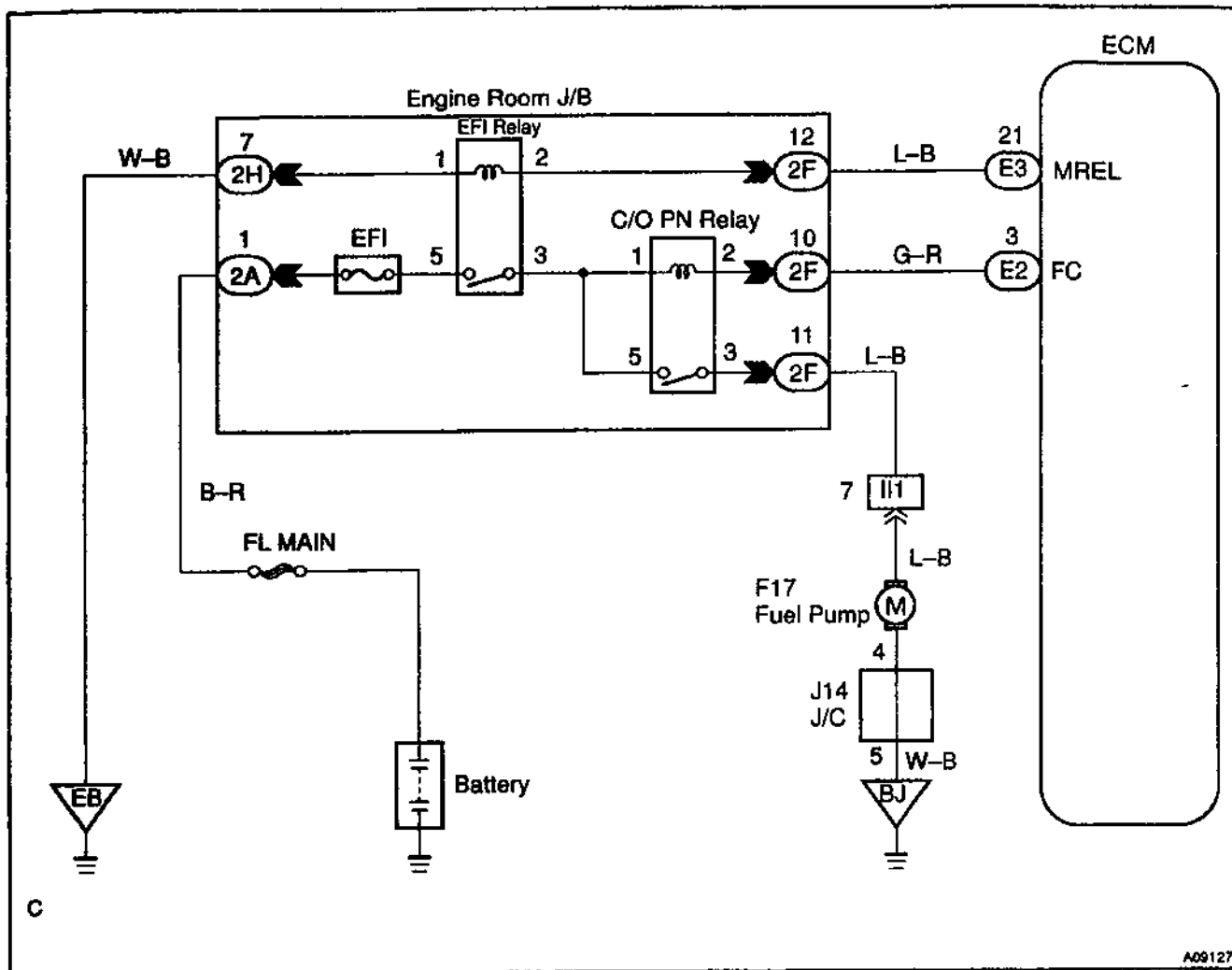

C

INSPECTION PROCEDURE

TOYOTA hand-held tester:

1	Connect the TOYOTA hand-held tester and check operation of fuel pump (See page DI-3).
---	---------------------------------------------------------------------------------------

OK	Proceed to next circuit inspection shown on problem symptoms table (See page DI-22).
----	--------------------------------------------------------------------------------------

NG

2	Check for ECM power source circuit (See page DI-146).
---	-------------------------------------------------------

NG	Repair or replace.
----	--------------------

OK

3	Check circuit opening relay (Marking: CIR OPN) (See page SF-53).
---	------------------------------------------------------------------

NG	Replace circuit opening relay.
----	--------------------------------

OK

4 Check voltage between terminal FC of ECM and body ground.

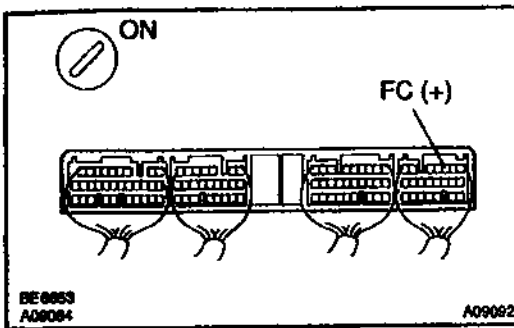
**PREPARATION:**

- (a) Remove the ECM cover.
- (b) Turn the ignition switch ON.

CHECK:

Measure voltage between terminal FC of the ECM and body ground.

OK:

Voltage 9 - 14 V

NG

Check for open in harness and connector between EFI main relay and circuit opening relay and ECM (See page IN-30).

OK

5 Check fuel pump (See page SF-6).

NG

Repair or replace fuel pump.

OK

6 Check for open in harness and connector between circuit opening relay (Marking: CIR OPN) and fuel pump and body ground (See page IN-30).

NG

Repair or replace harness or connector.

OK

Check and replace ECM (See page IN-30).

OBD II scan tool (excluding TOYOTA hand-held tester):

1 Check operation of fuel pump.

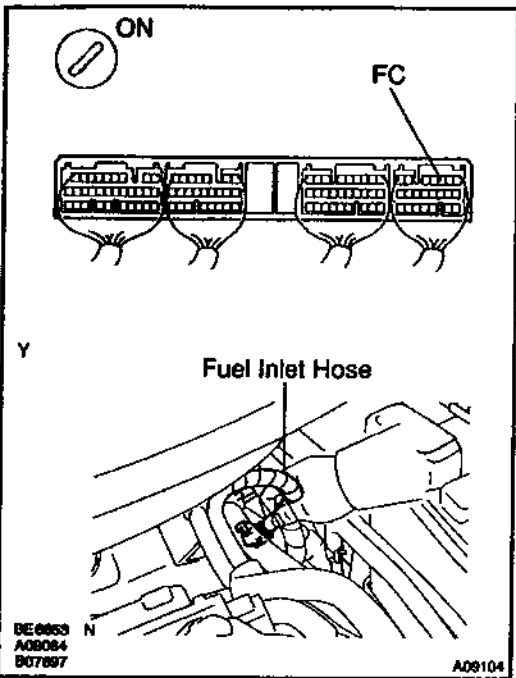

PREPARATION:

- (a) Remove the ECM cover.
- (b) Turn the ignition switch ON.

CHECK:

- (a) Connect between terminal FC of the ECM connector and body ground.
- (b) Check for fuel pressure in the fuel inlet hose when it is pinched off.

OK:

There is pressure in fuel inlet hose.

HINT:

At this time, you will hear a fuel return flowing noise.

OK Proceed to next circuit inspection shown on problem symptoms table (See page DI-22).

NG

2 Check for ECM power source circuit (See page DI-146).

NG Repair or replace.

OK

3 Check circuit opening relay (Marking: CIR OPN) (See page SF-53).

NG Replace circuit opening relay.

OK

4 Check voltage between terminal FC of ECM and body ground (See page DI-149, step 4).

NG Check for open in harness and connector between EFI main relay and circuit opening relay and ECM (See page IN-30).

OK

5 Check fuel pump (See page SF-6).

NG Repair or replace fuel pump.

OK

6 Check for open in harness and connector between circuit opening relay (Marking: CIR OPN) and fuel pump and body ground (See page IN-30).

NG Repair or replace harness or connector.

OK

Check and replace ECM (See page IN-30).

AUTOMATIC TRANSAXLE (U240E)

HOW TO PROCEED WITH TROUBLESHOOTING

0477-02

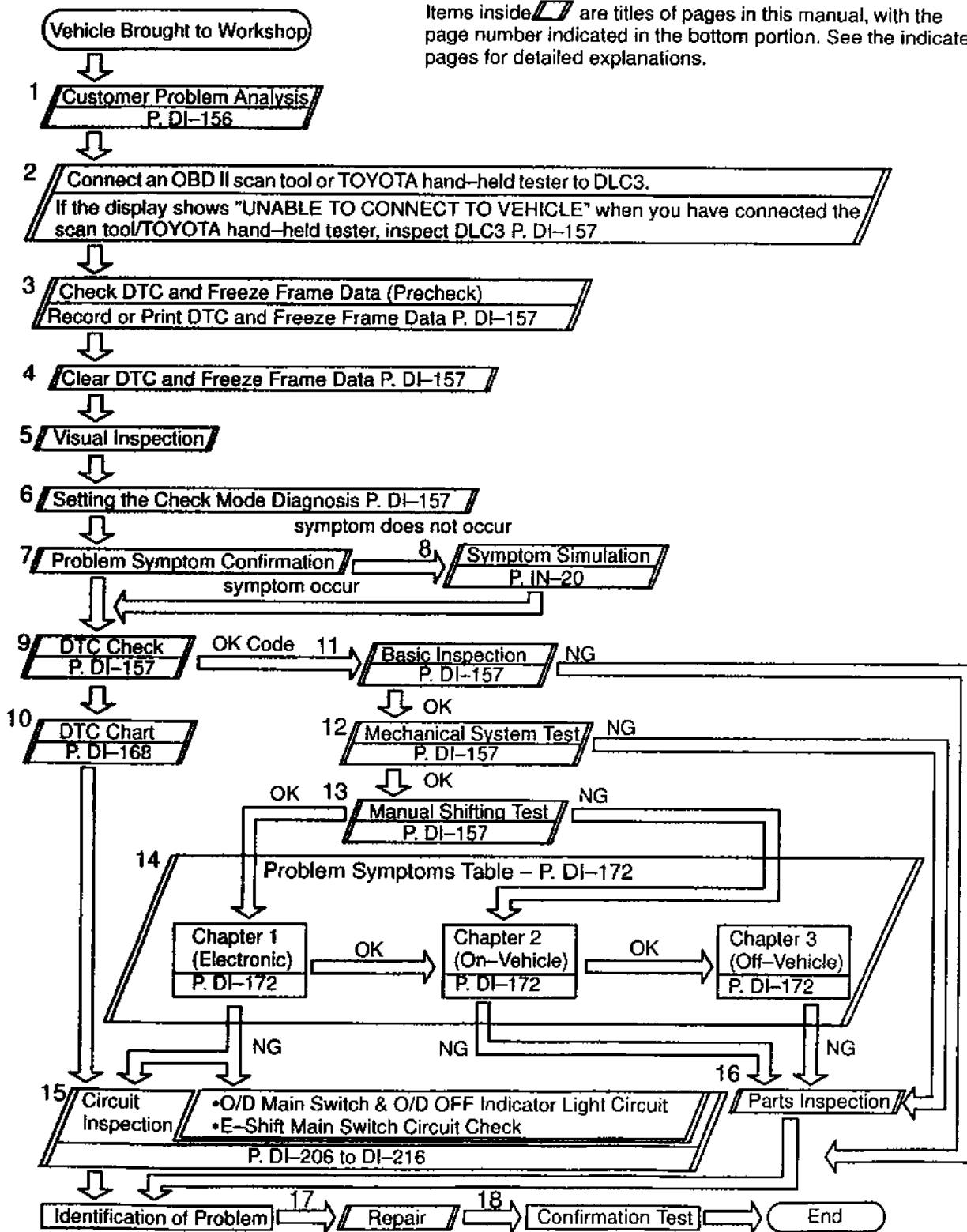

CUSTOMER PROBLEM ANALYSIS CHECK

Automatic Transaxle
System Check Sheet

Inspector's Name _____

Customer's Name	Registration No.	
	Registration Year	/ /
	Frame No.	
Date Vehicle Brought In	/ /	Odometer Reading km mile

Date Problem Occurred	/ /
How Often Does Problem Occur?	<input type="checkbox"/> Continuous <input type="checkbox"/> Intermittent (_____ times a day)

Symptoms	<input type="checkbox"/> Vehicle does not move (<input type="checkbox"/> Any position <input type="checkbox"/> Particular position)
	<input type="checkbox"/> No up-shift (<input type="checkbox"/> 1st → 2nd <input type="checkbox"/> 2nd → 3rd <input type="checkbox"/> 3rd → O/D)
	<input type="checkbox"/> No down-shift (<input type="checkbox"/> O/D → 3rd <input type="checkbox"/> 3rd → 2nd <input type="checkbox"/> 2nd → 1st)
	<input type="checkbox"/> Lock-up malfunction
	<input type="checkbox"/> Shift point too high or too low
	<input type="checkbox"/> Harsh engagement (<input type="checkbox"/> N → D <input type="checkbox"/> Lock-up <input type="checkbox"/> Any drive position)
	<input type="checkbox"/> Slip or shudder
	<input type="checkbox"/> No kick-down
<input type="checkbox"/> Others (_____)	

Check Item	Malfunction Indicator Lamp	<input type="checkbox"/> Normal <input type="checkbox"/> Remains ON
------------	----------------------------	---------------------------------------------------------------------

DTC Check	1st Time	<input type="checkbox"/> Normal code <input type="checkbox"/> Malfunction code (DTC _____)
	2nd Time	<input type="checkbox"/> Normal code <input type="checkbox"/> Malfunction code (DTC _____)

PRE-CHECK

1. DIAGNOSIS SYSTEM

(a) Description

- When troubleshooting OBD II vehicles, the only difference from the usual troubleshooting procedure is that you connect to the vehicle an OBD II scan tool complying with SAE J1987 or TOYOTA hand-held tester, and read off various data output from the vehicle's ECM.
- OBD II regulations require that the vehicle's on-board computer lights up the Malfunction Indicator Lamp (MIL) on the instrument panel when the computer detects a malfunction in the computer itself or in drive system components which affect vehicle emissions. In addition to the MIL lighting up when a malfunction is detected, the applicable DTCs prescribed by SAE J2012 are recorded in the ECM memory (See page DI-14).

If the malfunction only occurs in 3 trips, the MIL goes off but the DTCs remain recorded in the ECM memory.

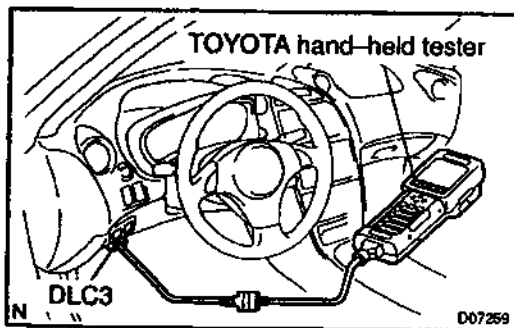
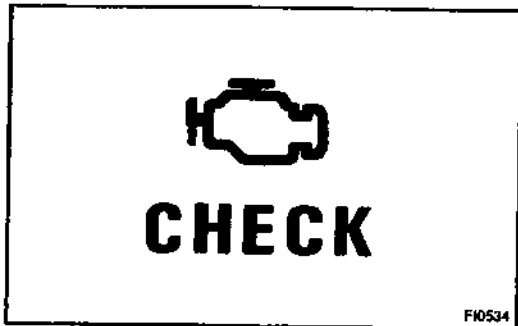

- To check the DTCs, connect an OBD II scan tool or TOYOTA hand-held tester to DLC3 on the vehicle. The OBD II scan tool or TOYOTA hand-held tester also enables you to erase the DTCs and check freeze frame data and various forms of engine data (For instruction book).
- DTCs include SAE controlled codes and Manufacturer controlled codes. SAE controlled codes must be set as prescribed by the SAE, while Manufacturer controlled codes can be set freely by the manufacturer within the prescribed limits (See DTC chart on page DI-168).

- The diagnosis system operates in normal mode during normal vehicle use, and also has a check mode for technicians to simulate malfunction symptoms and perform troubleshooting. Most DTCs use 2-trip detection logic (*) to prevent erroneous detection. By switching the ECM to check mode when troubleshooting, the technician can cause the MIL to light up and for a malfunction that is only detected once or momentarily.
(TOYOTA hand-held tester) (See page DI-157)
- *2-trip detection logic:
When a logic malfunction is first detected, the malfunction is temporarily stored in the ECM memory.

If the same malfunction is detected again during the 2nd test drive, this 2nd detection causes the MIL to light up .

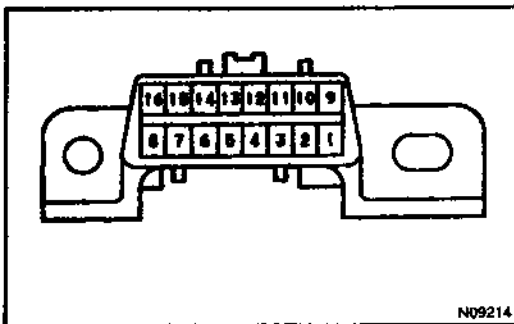

- (b) Inspect the DLC3.

The vehicle's ECM uses ISO 9141-2 for communication. The terminal arrangement of DLC3 complies with SAE J1962 and matches the ISO 9141-2 format.

Tester connection	Condition	Specified condition
7 (Bus ⊕ Line) – 5 (Signal ground)	During communication	Pulse generation
4 (Chassis Ground) – Body	Always	1 Ω or less
5 (Signal Ground) – Body	Always	1 Ω or less
16 (B*) – Body	Always	9 – 14 V

HINT:

If your display shows "UNABLE TO CONNECT TO VEHICLE" when you have connected the cable of OBD II scan tool or TOYOTA hand-held tester to DLC3, turned the ignition switch ON and operated the scan tool, there is a problem on the vehicle side or tool side.

- If communication is normal when the tool is connected to another vehicle, inspect DLC3 on the original vehicle.
- If communication is still not possible when the tool is connected to another vehicle, the problem is probably in the tool itself, so consult the Service Department listed in the tool's instruction manual.

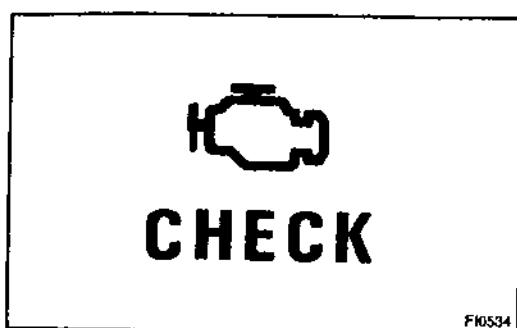

2. INSPECT DIAGNOSIS (NORMAL MODE)

- (a) Check the MIL.
- (1) The MIL comes on when the ignition switch is turned ON and the engine is not running.

HINT:

If the MIL does not light up, troubleshoot the combination meter (See page BE-2).

- (2) When the engine is started, the MIL should go off. If the lamp remains on, the diagnosis system has detected a malfunction or abnormality in the system.

- (b) Check the DTC.

NOTICE:

TOYOTA hand-held tester only: When the diagnostic system is switched from normal mode to check mode, it erases all DTCs and freeze frame data recorded in normal mode. So before switching modes, always check the DTCs and freeze frame data, and note them down.

- (1) Prepare an OBD II scan tool (complying with SAE J1978) or TOYOTA hand-held tester.
- (2) Connect the OBD II scan tool or TOYOTA hand-held tester to DLC3 at the lower of the instrument panel.
- (3) Turn the ignition switch ON and turn the OBD II scan tool or TOYOTA hand-held tester switch ON.
- (4) Use the OBD II scan tool or TOYOTA hand-held tester to check the DTCs and freeze frame data and note them down (For operating instructions, see the OBD II scan tool's instruction book).
- (5) See page DI-168 to confirm the details of the DTCs.

NOTICE:

When simulating symptoms with an OBD II scan tool (excluding TOYOTA hand-held tester) to check the DTCs, use normal mode. For codes on the DTCs chart subject to "2-trip detection logic", turn the ignition switch OFF after the symptoms have been simulated the 1st time. Then repeat the simulation process again. When the program has DTCs are recorded in the ECM.

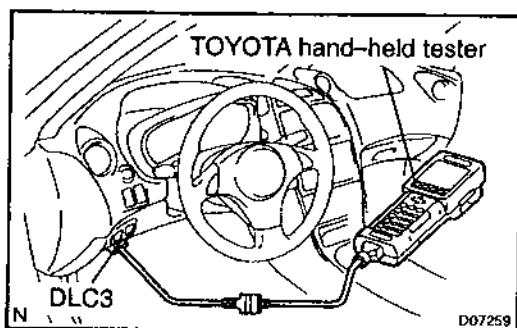

3. INSPECT DIAGNOSIS (CHECK MODE)

HINT:

TOYOTA hand-held tester only: Compared to the normal mode, the check mode has high sensing ability to detect malfunctions. Furthermore, the same diagnostic items which are detected in Normal mode can also be detected in Check mode.

(a) Check the DTC.

- (1) Check the initial conditions.
 - Battery positive voltage 11 V or more.
 - Throttle valve fully closed.
 - Transaxle in P position.
 - Air conditioning switched off.
- (2) Turn the ignition switch OFF.
- (3) Prepare a TOYOTA hand-held tester.

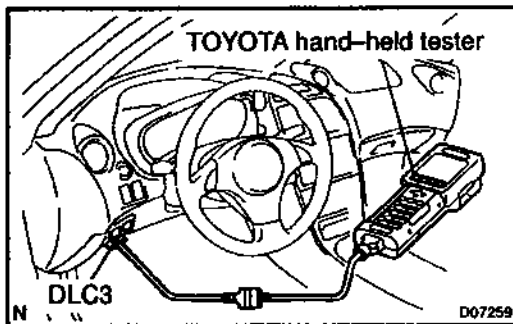

- (4) Connect the TOYOTA hand-held tester to DLC3 at the lower of the instrument panel.
- (5) Turn the ignition switch ON and switch the TOYOTA hand-held tester ON.

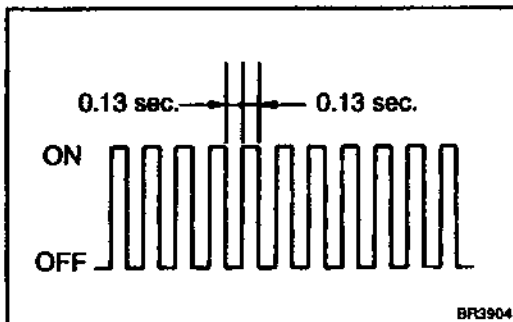

- (6) Switch the TOYOTA hand-held tester from Normal mode to Check mode (Check that the MIL flashes).
- (7) Start the engine (MIL goes out after the engine starts).
- (8) Simulate the conditions of the malfunction described by the customer.

NOTICE:

Leave the Ignition switch ON until you have checked the DTCs, etc.

- (9) After simulating the malfunction conditions, use the TOYOTA hand-held tester diagnosis selector to check the DTCs and freeze frame data, etc.

HINT:

Take care not to turn the ignition switch OFF, as turning it off the diagnosis system from Check mode to Normal mode, so all DTCs, etc. are erased.

- (10) After checking the DTC, inspect the applicable circuit.

(b) Clear the DTC.

The following operation will erase the DTC and freeze frame data. Operating an OBD II scan tool (complying with SAE J1978) or TOYOTA hand-held tester to erase the codes.

(See the OBD II scan tool's instruction book for operating instructions.)

NOTICE:

If the TOYOTA hand-held tester switches the ECM from Normal mode to Check mode or vice-versa, or if the Ignition switch is turned from ON to ACC or OFF during check mode, the DTCs and freeze frame data will be erased.

4. PROBLEM SYMPTOM CONFIRMATION

Taking into consideration the results of the customer problem analysis, try to reproduce the symptoms of the trouble. If the problem is that the transaxle does not up-shift, down-shift, or the shift point is too high or too low, conduct the following road test to confirm the automatic shift schedule and simulate the problem symptoms.

5. ROAD TEST**NOTICE:**

Perform the test at normal operating ATF temperature 50 – 80 °C (122 – 176 °F).

(a) D position test

Shift into the D position and fully depress the accelerator pedal and check the following points.

(1) Check up-shift operation.

Check to see that 1 → 2, 2 → 3 and 3 → O/D up-shift takes place, and that the shift points conform to the automatic shift schedule (See page SS-41).

HINT:

- O/D Gear Up-shift Prohibition Control (1. Coolant temp. is 60 °C (140 °F) or less. 2. If there is a 10 km/h (6 mph) difference between the set cruise control speed and vehicle speed.)
 - O/D Gear Lock-up Prohibition Control (1. Brake pedal is depressed. 2. Coolant temp. is 60 °C (140 °F) or less.)
- (2) Check for shift shock and slip.
Check for shock and slip at the 1 → 2, 2 → 3 and 3 → O/D up-shifts.
- (3) Check for abnormal noises and vibration.
Drive in the D position lock-up or O/D gear and check for abnormal noises and vibration.

HINT:

The check for the cause of abnormal noises and vibration must be done very thoroughly as it could also be due to loss of balance in the differential torque converter clutch, etc.

(4) Check kick-down operation.

While running in the D position, 2nd, 3rd and O/D gears, check to see that the possible kick-down vehicle speed limits for 2 → 1, 3 → 2 and O/D → 3 kick-downs conform to those indicated on the automatic shift schedule (See page SS-41).

(5) Check abnormal shock and slip at kick-down.

(6) Check the lock-up mechanism.

- Drive in D position, O/D gear, at a steady speed (lock-up ON) of about 60 km/h (37 mph).
- Lightly depress the accelerator pedal and check that the engine speed does not change abruptly.

If there is a big jump in engine speed, there is no lock-up.

(b) M position test

Shift to the M position, depress the accelerator pedal and check the following points.

Shift operations.

Pressing the transmission shift switch to "UP" or "Down" makes the transmission up-shifted or down-shifted respectively.

Without pressing the switch, it is not automatically shifted to neither up or down.

When a vehicle is stopped, it is automatically down-shifted to 1st gear.

HINT:

Manual shift prohibition control (1. When the ATF temperature is low. 2. When down-shifting causes engine overrun. 3. When down-shifting is required continuously, down-shifting to 1st gear may not be performed. 4. When the ATF temp. is high, up-shifting to O/D is not performed.)

(c) 2 position test

Shift into the 2 position and fully depress the accelerator pedal and check the following points.

(1) Check up-shift operation.

Check to see that the 1 → 2 up-shift takes place and that the shift point conforms to the automatic shift schedule (See page SS-41).

HINT:

There is no O/D up-shift and lock-up in the 2 position.

(2) Check engine braking.

While running in the 2 position and 2nd gear, release the accelerator pedal and check the engine braking effect.

(3) Check for abnormal noises during acceleration and deceleration, and for shock at up-shift and down-shift.**(d) L position test**

Shift into the L position and fully depress the accelerator pedal and check the following points.

(1) Check no up-shift.

While running in the L position, check that there is no up-shift to 2nd gear.

(2) Check engine braking.

While running in the L position, release the accelerator pedal and check the engine braking effect.

(3) Check for abnormal noises during acceleration and deceleration.**(e) R position test**

Shift into the R position and fully depress the accelerator pedal and check for slipping.

CAUTION:

Before conducting this test ensure that the test area is free from people and obstruction.

(f) P position test

Stop the vehicle on a grade (more than 5°) and after shifting into the P position, release the parking brake. Then, check to see that the parking lock pawl holds the vehicle in place.

6. BASIC INSPECTION

(a) Check the fluid level.

HINT:

- Drive the vehicle so that the engine and transaxle are at normal operating temperature.

Fluid temp.: 70 – 80 °C (158 – 176 °F)

- Only use the COOL range on the dipstick as a rough reference when the fluid is replaced or the engine does not run.

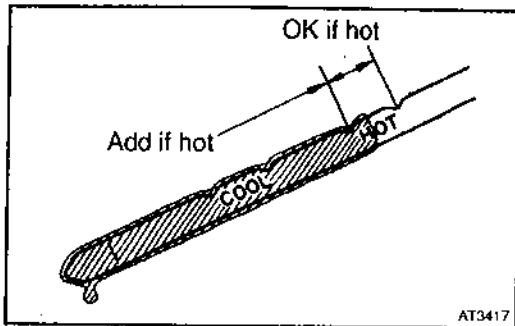

- (1) Park the vehicle on a level surface and set the parking brake.
- (2) With the engine idling and the brake pedal depressed, shift the shift lever into all positions from P to L position and return to P position.
- (3) Pull out the dipstick and wipe it clean.
- (4) Push it back fully into the pipe.
- (5) Pull it out and check that the fluid level is in the HOT range.

If the level is at the low side, add new fluid.

Fluid type: ATF Type T-IV**Capacity: 4.1 liters (4.3 US qts, 3.6 Imp. qts)****NOTICE:****Do not overfill.**

(b) Check the fluid condition.

If the fluid smells burnt or is black, replace it.

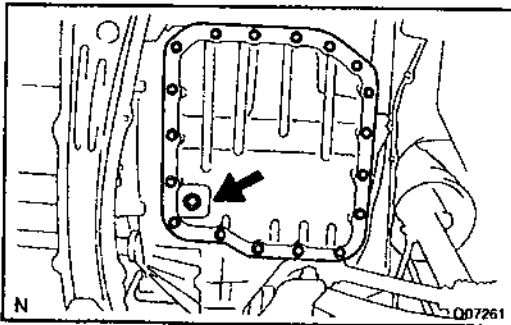

(c) Replace the ATF.

- (1) Remove the drain plug and drain the fluid.
- (2) Reinstall the drain plug securely.

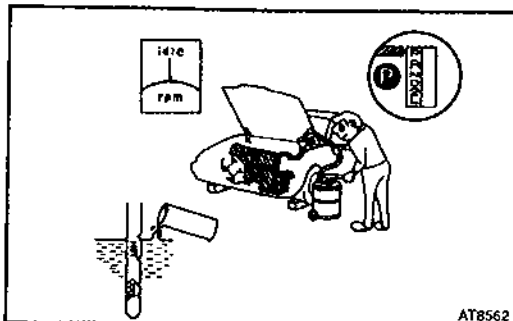

- (3) With the engine OFF add new fluid through the oil filler pipe.

Fluid type: ATF Type T-IV**Capacity: 4.1 liters (4.3 US qts, 3.6 Imp. qts)**

- (4) Start the engine and shift the shift lever into all positions from P to L position and then shift into P position.

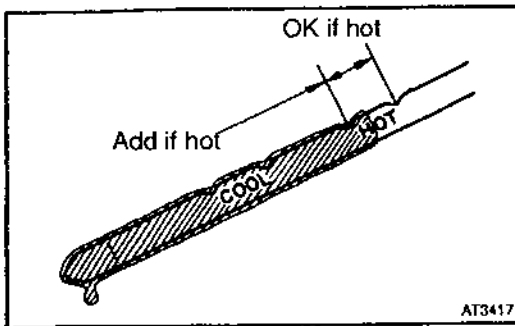

- (5) With the engine idling, check the fluid level. Add fluid up to the COOL level on the dipstick.
- (6) Check the fluid level at the normal operating temperature, 70 – 80 °C (158 – 176 °F), and add as necessary.

NOTICE:

Do not overfill.

- (d) Check the fluid leaks.

Check for leaks in the transaxle.

If there are leaks, it is necessary to repair or replace O-rings, gaskets, oil seals, plugs or other parts.

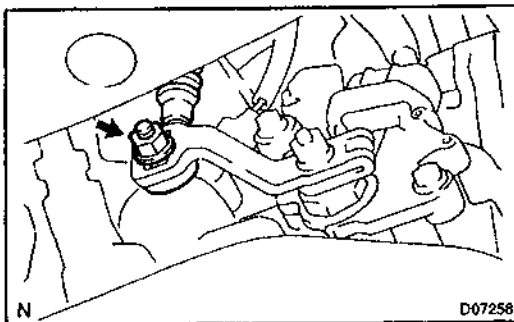

- (e) Inspect and adjust the shift lever position. When shifting the shift lever from the N position to other positions, check that the lever can be shifted smoothly and accurately to each position and that the position indicator is not aligned with the correct position.

If the indicator is not aligned with the correct position, carry out the following adjustment procedures.

- (1) Loosen the nut on the shift lever.
- (2) Push the control shaft fully downward.
- (3) Return the control shaft lever 2 notches to N position.
- (4) Set the shift lever to N position.
- (5) While holding the shift lever lightly toward the R position side, tighten the shift lever nut.

Torque: 13 N·m (130 kgf·cm, 9 ft·lbf)

- (6) Start the engine and make sure that the vehicle moves forward when shifting the lever from the N to D position and reverses when shifting it to the R position.

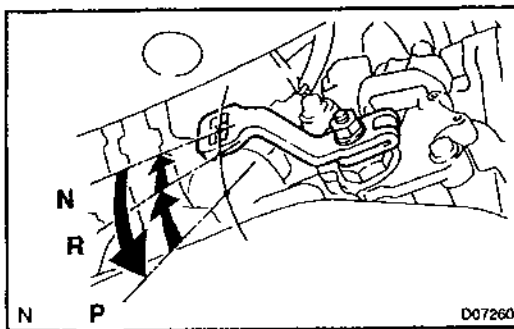

- (f) Inspect and adjust the park/neutral position. Check that the engine can be started with the shift lever only in the N or P position, but not in other positions.

If it is not as stated above, carry out the following adjustment procedures.

- (1) Loosen the park/neutral position switch bolt and set the shift lever to the N position.
- (2) Align the groove and neutral basic line.

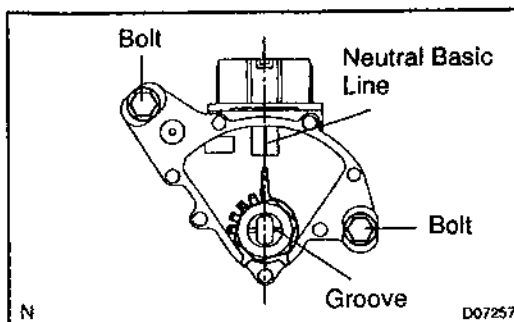

(3) Hold in position and tighten the bolt.

Torque: 5.4 N·m (55 kgf·cm, 48 in·lbf)

For continuity inspection of the park/neutral position switch, see page DI-202.

(g) Check the idle speed.

Idle speed: 650 ± 50 rpm

(In N position and air conditioner OFF)

7. MECHANICAL SYSTEM TESTS

(a) Measure the stall speed.

The object of this test is to check the overall performance of the transaxle and engine by measuring the stall speeds in the D and R positions.

NOTICE:

- Do the test at normal operating fluid temperature 50 – 80 °C (122 – 176 °F).
- Do not continuously run this test longer than 10 seconds.
- To ensure safety, conduct this test in a wide, clear level area which provides good traction.
- The stall test should always be carried out in pairs. One technician should observe the conditions of wheels or wheel stoppers outside the vehicle while the other is doing the test.

(1) Chock the 4 wheels.

(2) Connect an OBD II scan tool or TOYOTA hand-held tester to DLC3.

(3) Fully apply the parking brake.

(4) Keep your left foot pressed firmly on the brake pedal.

(5) Start the engine.

(6) Shift into the D position. Press all the way down on the accelerator pedal with your right foot. Quickly read the stall speed at this time.

Stall speed: 2,370 ± 150 rpm

Evaluation:

Problem	Possible cause
(a) Stall speed low in D and R positions	<ul style="list-style-type: none"> • Engine output may be insufficient • Stator one-way clutch is operating properly <p>HINT: If more than 600 rpm below the specified value, the torque converter clutch could be faulty.</p>
(b) Stall speed high in D position	<ul style="list-style-type: none"> • Line pressure too low • Forward clutch slipping • No.2 one-way clutch not operating properly • O/D clutch slipping
(c) Stall speed high in R position	<ul style="list-style-type: none"> • Line pressure too low • Direct clutch slipping • 1st & reverse brake slipping • O/D clutch slipping
(d) Stall speed high in D and R positions	<ul style="list-style-type: none"> • Line pressure too low • Improper fluid level • O/D one-way clutch not operating properly

(b) Measure the time lag.

When the shift lever is shifted while the engine is idling, there will be a certain time lapse or lag before the shock can be felt. This is used for checking the condition of the O/D direct clutch, forward clutch, and 1st & reverse brake.

NOTICE:

- Do the test at normal operating fluid temperature 50 – 80 °C (122 – 176 °F).
- Be sure to allow 1 minute interval between tests.
- Take 3 measurements and take the average value.

(1) Connect an OBD II scan tool or TOYOTA hand-held tester to DLC3.

(2) Fully apply the parking brake.

(3) Start the engine and check idle speed.

Idle speed: 650 ± 50 rpm (in N position and air conditioner OFF)

(4) Shift the shift lever from N to D position. Using a stop watch, measure the time from when the lever is shifted until the shock is felt.

Time lag: N → D Less than 1.2 seconds

(5) In the same manner, measure the time lag for N → R.

Time lag: N → R Less than 1.5 seconds

Evaluation (If N → D time or N → R time lag is longer than specified):

Problem	Possible cause
N → D time lag is longer	<ul style="list-style-type: none"> • Line pressure too low • Forward clutch worn • O/D one-way clutch not operating
N → R time lag is longer	<ul style="list-style-type: none"> • Line pressure too low • Direct clutch worn • 1st & reverse brake worn • O/D one-way clutch not operating properly

8. HYDRAULIC TEST

Measure the line pressure.

NOTICE:

- **Do the test at normal operation fluid temperature 50 – 80 °C (122 – 176 °F)**
- **The line pressure test should always be carried out in pairs. One technician should observe the conditions of wheels or wheel stoppers outside the vehicle while the other is doing the test.**
- **Be careful to prevent SST's hose from interfering with the exhaust pipe.**

(1) Warm up the ATF.

(2) Remove the test plug on the transaxle case front left side and connect SST.
(See page AX-30 for the location to connect SST)

SST 09992-00095 (09992-00231, 09992-00271)

(3) Fully apply the parking brake and chock the 4 wheels.

(4) Connect an OBD II scan tool or TOYOTA hand-held tester to DLC3.

(5) Start the engine and check idling speed.

(6) Keep your left foot pressed firmly on the brake pedal and shift into D position.

(7) Measure the line pressure when the engine is idling.

(8) Depress the accelerator pedal all the way down. Quickly read the highest line pressure when engine speed reaches stall speed.

(9) In the same manner, do the test in R position.

Specified line pressure:

Condition	D position	R position
	kPa (kgf/cm ² , psi)	kPa (kgf/cm ² , psi)
Idling	372 – 412 (3.8 – 4.2, 54 – 59)	672 – 742 (6.9 – 7.6, 97 – 107)
Stall	931 – 1,031 (9.5 – 10.5, 134 – 149)	1,768 – 1,968 (18.0 – 20.1, 255 – 284)

Evaluation:

Problem	Possible cause
If the measured values at all position are higher	<ul style="list-style-type: none"> • Throttle valve defective • Regulator valve defective
If the measured values at all position are lower	<ul style="list-style-type: none"> • Throttle valve defective • Regulator valve defective • Oil pump defective • O/D direct clutch defective
If pressure is low in the D position only	<ul style="list-style-type: none"> • D position circuit fluid leakage • Forward clutch defective
If pressure is low in the R position only	<ul style="list-style-type: none"> • R position circuit fluid leakage • Direct clutch defective • 1st & reverse brake defective

9. MANUAL SHIFTING TEST**HINT:**

With this test, it can be determined whether the trouble is within the electrical circuit or is a mechanical problem in the transaxle.

- (a) Disconnect the solenoid wire.
- (b) Inspect the manual driving operation.

Check that the shift and gear positions correspond with the table below.

While driving, shift through the L, 2 and D positions. Check that the gear change corresponds to the shift position.

Shift Position	Gear Position
D	O/D
2	O/D
L	1st
R	Reverse
P	Pawl Lock

HINT:

If the L, 2 and D position gear positions are difficult to positions are difficult to distinguish, do the following read test.

If any abnormality is found in the above test, the problem is in the transaxle itself.

- (c) Connect the solenoid wire.
- (d) Cancel out DTC (See page DI-157).

DIAGNOSTIC TROUBLE CODE CHART

If a DTC is displayed during the DTC check, check the circuit listed for that code in the table below and proceed to the page given.

* : ...MIL does not light / ●...MIL light up

DTC No. (See Page)	Detection Item	Trouble Area	MIL *	Memory
P0500 (DI-175)	Vehicle Speed Sensor Malfunction	<ul style="list-style-type: none"> • Open or short in vehicle speed sensor circuit • Vehicle speed sensor • Combination meter • ECM • Automatic transaxle assembly 	●	○
P0710 (DI-179)	Transmission Fluid Temperature Sensor Malfunction	<ul style="list-style-type: none"> • Open or short in ATF temperature sensor circuit • ATF temperature sensor • ECM 	●	○
P0750 (DI-181)	Shift Solenoid A Malfunction (Shift Solenoid Valve SL1)	<ul style="list-style-type: none"> • Shift solenoid valve SL1 is stuck open or closed • Valve body is blocked up or stuck 	●	○
P0753 (DI-183)	Shift Solenoid A Electrical Malfunction (Shift Solenoid Valve SL1)	<ul style="list-style-type: none"> • Open or short in shift solenoid valve SL1 circuit • Shift solenoid valve SL1 • ECM 	●	○
P0755 (DI-181)	Shift Solenoid B Malfunction (Shift Solenoid Valve SL2)	<ul style="list-style-type: none"> • Shift solenoid valve SL2 is stuck open or closed • Valve body is blocked up or stuck 	●	○
P0758 (DI-183)	Shift Solenoid B Electrical Malfunction (Shift Solenoid Valve SL2)	<ul style="list-style-type: none"> • Open or short in shift solenoid valve SL2 circuit • Shift solenoid valve SL2 • ECM 	●	○
P0765 (DI-181)	Shift Solenoid D Malfunction (Shift Solenoid Valve S4)	<ul style="list-style-type: none"> • Shift solenoid valve S4 is stuck open or closed • Valve body is blocked up or stuck 	●	○
P0768 (DI-183)	Shift Solenoid D Electrical Malfunction (Shift Solenoid Valve S4)	<ul style="list-style-type: none"> • Open or short in shift solenoid valve S4 circuit • Shift solenoid valve S4 • ECM 	●	○
P0770 (DI-189)	Shift Solenoid E Malfunction (Shift Solenoid Valve DSL)	<ul style="list-style-type: none"> • Shift solenoid valve DSL is stuck open or closed • Valve body is blocked up or stuck • Lock-up clutch 	●	○
P0773 (DI-191)	Shift Solenoid E Electrical Malfunction (Shift Solenoid Valve DSL)	<ul style="list-style-type: none"> • Open or short in shift solenoid valve DSL circuit • Shift solenoid valve DSL • ECM 	●	○
P1520 (DI-194)	Stop Light Switch Circuit	<ul style="list-style-type: none"> • Open or short in stop light switch circuit • Stop light switch • ECM 	●	○
P1725 (DI-195)	NT Revolution Sensor Circuit Malfunction (Input Turbine Speed Sensor)	<ul style="list-style-type: none"> • Open or short in input turbine speed sensor circuit • Input turbine speed sensor • ECM 	●	○
P1730 (DI-197)	NC Revolution Sensor Circuit Malfunction (Counter Gear Speed Sensor)	<ul style="list-style-type: none"> • Open or short in counter gear speed sensor circuit • Counter gear speed sensor • ECM 	●	○
P1760 (DI-199)	Linear Solenoid for Accumulator Pressure Control Circuit Malfunction (Shift Solenoid Valve SLT)	<ul style="list-style-type: none"> • Open or short in shift solenoid valve SLT circuit • Shift solenoid valve SLT • ECM 	●	○
P1780 (DI-202)	Park/Neutral Position Switch Malfunction	<ul style="list-style-type: none"> • Short in park/neutral position switch circuit • Park/neutral position switch • ECM 	●	○

PARTS LOCATION

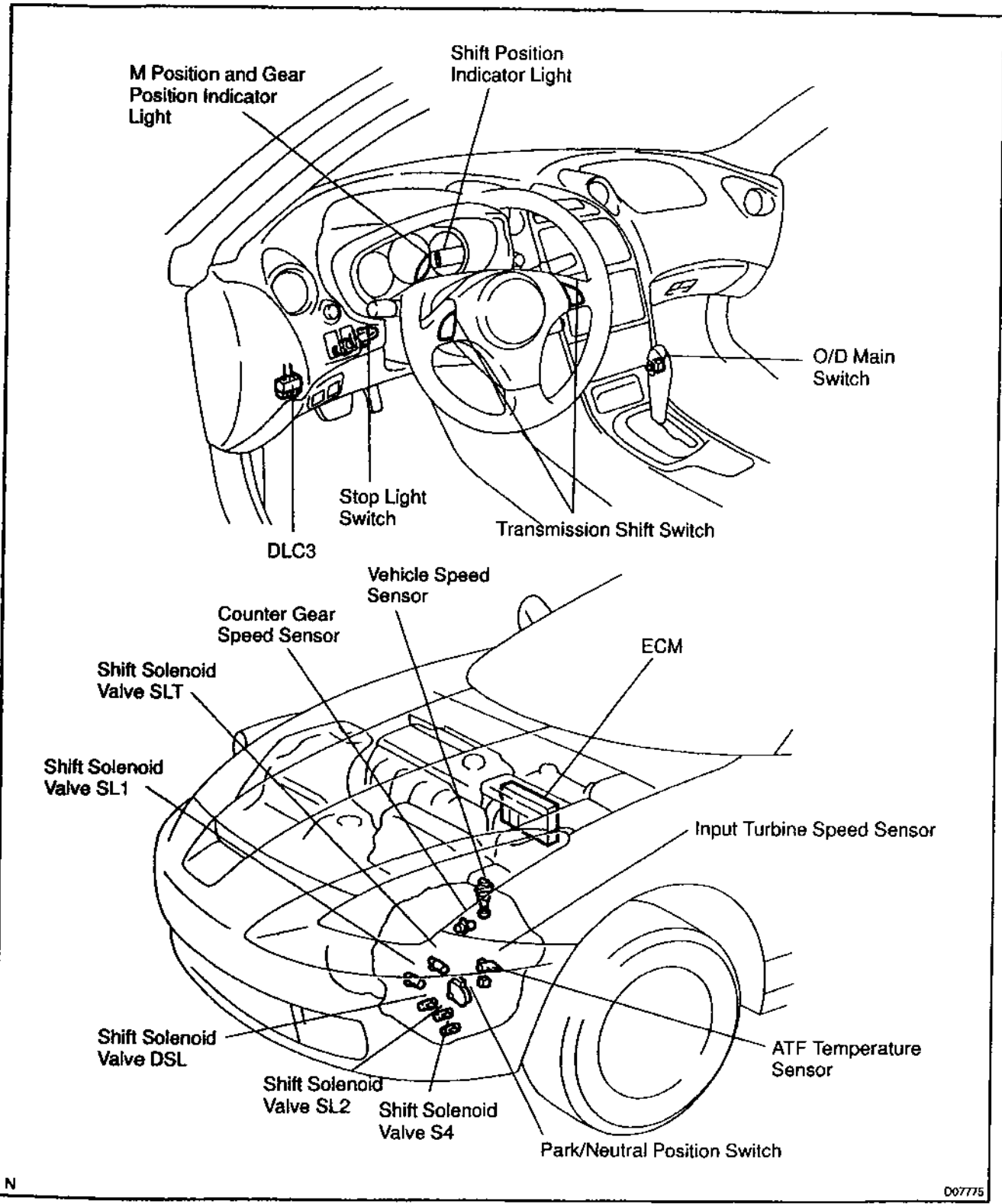

TERMINALS OF ECM

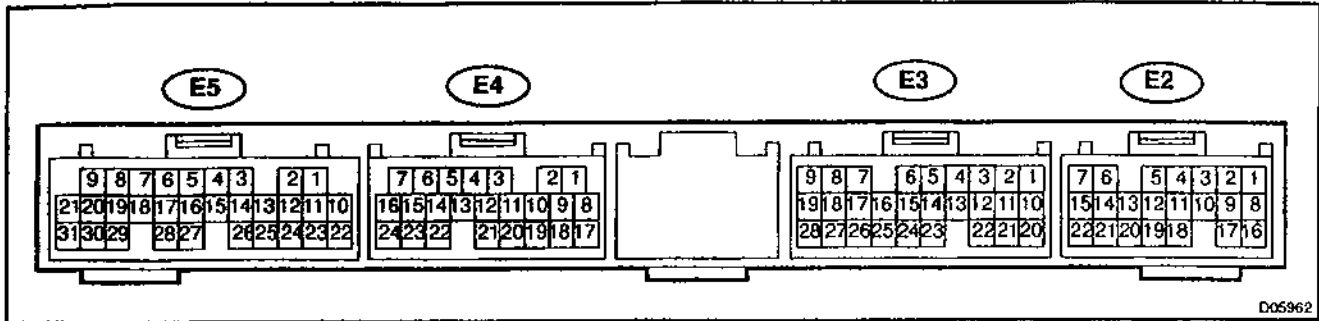

Symbols (Terminals No.)	Wiring Color	Condition	STD Voltage (V)
SL1 ⁺ (E5-7) ↔ SL1 ⁻ (E5-9)	G ↔ V	IG ON	10 - 14
		1st or 2nd gear	10 - 14
		3rd or O/D gear	Below 1
SL2 ⁺ (E5-8) ↔ SL2 ⁻ (E5-20)	BR-Y ↔ O	IG ON	Below 1
		1st or 2nd gear	10 - 14
		3rd or O/D gear	Below 1
DSL (E5-19) ↔ Body ground	G-W ↔ Body ground	IG ON	Below 1
		Vehicle driving under lock-up position	10 - 14
NC ⁺ (E5-14) ↔ NC ⁻ (E5-26)	P-B ↔ G-W	Engine is running	Pulse signal is output Below 1 ↔ 4 - 5
NT ⁺ (E5-16) ↔ NT ⁻ (E5-15)	W-L ↔ B	Engine is running	Pulse signal is output Below 1 ↔ 4 - 5
SLT ⁺ (E5-6) ↔ SLT ⁻ (E5-5)	Y-R ↔ Y-G	IG ON	10 - 14
OD1 (E3-1) ↔ E1 (E4-17)	B ↔ BR	IG ON	5 - 6
ODLP (E3-19) ↔ E1 (E4-17)	BR-Y ↔ BR	O/D main switch ON	10 - 14
		O/D main switch OFF	Below 1
L (E4-9) ↔ E1 (E4-17)	Y-B ↔ BR	IG ON and Shift lever L position	10 - 14
		IG ON and Shift lever other than L position	Below 1
2 (E4-19) ↔ E1 (E4-17)	L-Y ↔ BR	IG ON and Shift lever 2 position	10 - 14
		IG ON and Shift lever other than 2 position	Below 1
R (E3-2) ↔ E1 (E4-17)	R-B ↔ BR	IG ON and Shift lever R position	10 - 14
		IG ON and Shift lever other than R position	Below 1
D (E3-24) ↔ E1 (E4-17)	L-W ↔ BR	IG ON and Shift lever D position	10 - 14
		IG ON and Shift lever other than D position	Below 1
N (E4-8) ↔ E1 (E4-17)	P-L ↔ BR	IG ON and Shift lever P or N position	10 - 14
		IG ON and Shift lever other than P or N position	Below 1
THO (E4-13) ↔ E2 (E4-18)	GR-L ↔ BR	IG ON and ATF temperature 110 °C (230 °F)	Below 1
S4 (E5-29) ↔ E1 (E4-17)	Y ↔ BR	IG ON	Below 1
		IG ON and O/D gear	10 - 14
P (E4-20) ↔ E1 (E4-17)	P ↔ BR	IG ON and Shift lever P position	10 - 14
		IG ON and Shift lever other P position	Below 1
SFTU (E2-9) ↔ E1 (E4-17)	L ↔ BR	IG ON and "UP" transmission shift switch pressed	Below 1
		IG ON and "UP" transmission shift switch repressed	10 - 14

DIAGNOSTICS -- AUTOMATIC TRANSAXLE (U240E)

SFTD (E2-17) ↔ E1 (E4-17)	P ↔ BR	IG ON and "Down" transmission shift switch pressed	Below 1
		IG ON and "Down" transmission shift switch repressed	10 - 14
SPD (E3-22) ↔ E1 (E4-17)	W-R ↔ BR	IG ON and Vehicle stationary	Below 1
		IG ON and Turn one front wheel slowly	Pulse signal is output Below 1 ↔ 4 - 6
ODMS (E2-5) ↔ E1 (E4-17)	BR-Y ↔ BR	IG ON	Below 1
		IG ON and Press continuously O/D main switch	10 - 14

PROBLEM SYMPTOMS TABLE

If a normal code is displayed during the diagnostic trouble code check but the trouble still occurs, check the circuits for each symptom in the order given in the charts on the following pages and proceed to the page given for troubleshooting.

The Matrix Chart is divided into 3 chapters.

Chapter 1: Electronic circuit matrix chart

Chapter 2: On-vehicle repair matrix chart

Chapter 3: Off-vehicle repair matrix chart

If the instruction "Proceed to next circuit inspection shown on matrix chart" is given in the flow chart for each circuit, proceed to the circuit with the next highest number in the table to continue the check.

If the trouble still occurs even though there are no abnormalities in any of the other circuits, then check and replace the ECM.

Chapter 1: Electronic circuit matrix chart

Symptom	Suspect Area	See page
No up-shift (A particular gear, from 1st to 3rd gear, is not up-shifted)	ECM	IN-30
No up-shift (3rd → O/D)	1. O/D main switch circuit 2. O/D cancel signal circuit 3. ECM	DI-206 DI-209 IN-30
No down-shift (O/D → 3rd)	ECM	IN-30
No down-shift (A particular gear, from 3rd to 1st gear, is not down-shifted)	ECM	IN-30
No lock-up or No lock-up off	ECM	IN-30
Shift point too high or too low	ECM	IN-30
Up-shift to 2nd while in L position	ECM	IN-30
Up-shift to 3rd while in 2 position	ECM	IN-30
Up-shift to O/D from 3rd while O/D main switch is OFF	1. O/D main switch circuit 2. ECM	DI-206 IN-30
Up-shift to O/D from 3rd while engine is cold	ECM	IN-30
Harsh engagement (N → D)	ECM	IN-30
Harsh engagement (Lock-up)	ECM	IN-30
Harsh engagement (Any driving position)	ECM	IN-30
Poor acceleration	ECM	IN-30
Engine stalls when starting off or stopping	ECM	IN-30
No E-shift system	1. Transmission shift main switch circuit 2. Transmission shift switch circuit 3. ECM	DI-216 DI-212 IN-30

Chapter 2: On-vehicle repair**(★: U240E automatic transaxle repair manual Pub. No. RM740U)**

Symptom	Suspect Area	See page
Vehicle does not move in any forward position and reverse position	1. Manual valve 2. Primary regulator valve 3. Off-vehicle repair matrix chart	★ ★ -
Vehicle does not move in R position	Off-vehicle repair matrix chart	-
No up-shift (1st → 2nd)	1. 1-2 shift valve 2. Off-vehicle repair matrix chart	★ -
No up-shift (2nd → 3rd)	1. 2-3 shift valve 2. Off-vehicle repair matrix chart	★ -
No up-shift (3rd → O/D)	1. 3-4 shift valve 2. Off-vehicle repair matrix chart	★ -
No down-shift (O/D → 3rd)	3-4 shift valve	★
No down-shift (3rd → 2nd)	2-3 shift valve	★
No down-shift (2nd → 1st)	1-2 shift valve	★
No lock-up or No lock-up off	1. Lock-up relay valve 2. Off-vehicle repair matrix chart	★ -
Harsh engagement (N → D)	1. C ₁ accumulator 2. Off-vehicle repair matrix chart	★ -
Harsh engagement (N → R)	1. C ₂ accumulator 2. Off-vehicle repair matrix chart	★
Harsh engagement (Lock-up)	1. Lock-up relay valve 2. Off-vehicle repair matrix chart	★ -
Harsh engagement (2nd → 3rd)	C ₂ accumulator	★
Harsh engagement (3rd → O/D)	B ₀ accumulator	★
Harsh engagement (O/D → 3rd)	1. C ₀ accumulator 2. B ₀ accumulator	★ ★
Slip or shudder (Forward and reverse)	1. Oil strainer 2. Off-vehicle repair matrix chart	★ -
No engine braking (1st: L position)	Off-vehicle repair matrix chart	-
No engine braking (2nd: 2 position)	Off-vehicle repair matrix chart	-
No kick-down	1. 1-2 shift valve 2. 2-3 shift valve 3. 3-4 shift valve	★ ★ ★

Chapter 3: Off-vehicle repair

(★: U240E automatic transaxle repair manual Pub. No. RM740U)

Symptom	Suspect Area	See page
Vehicle does not move in any forward position and reverse position	1. Front and rear planetary gear	★
	2. U/D planetary gear	★
	3. U/D one-way clutch (F ₂)	★
	4. Forward clutch (C ₁)	★
	5. U/D brake (B ₃)	★
Vehicle does not move in R position	1. Front and rear planetary gear unit	★
	2. U/D planetary gear unit	★
	3. Direct clutch (C ₂)	★
	4. U/D brake (C ₃)	★
	5. 1st & reverse brake (B ₂)	★
No up-shift (1st → 2nd)	1. No. 1 one-way clutch (F ₁)	★
	2. 2nd brake (B ₁)	★
No up-shift (2nd → 3rd)	Direct clutch (C ₂)	★
No up-shift (3rd → O/D)	U/D clutch (C ₃)	★
No lock-up or No lock-up off	Torque converter clutch	AX-36
Harsh engagement (N → D)	1. Forward clutch (C ₁)	★
	2. U/D one-way clutch (F ₂)	★
	3. No. 1 one-way clutch (F ₁)	★
Harsh engagement (N → R)	1. Direct clutch (C ₂)	★
	2. 1st & reverse brake (B ₂)	★
Harsh engagement (Lock-up)	Torque converter clutch	AX-36
Slip or shudder (Forward position: After warm-up)	1. Torque converter clutch	AX-36
	2. Forward clutch (C ₁)	★
	3. Direct clutch (C ₂)	★
	4. U/D brake (C ₃)	★
	5. No. 1 one-way clutch (F ₁)	★
	6. U/D one-way clutch (F ₂)	★
Slip or shudder (R position)	1. Direct clutch (C ₂)	★
	2. 1st & reverse brake (B ₂)	★
Slip or shudder (1st)	No. 1 one-way clutch (F ₁)	★
Slip or shudder (2nd)	1. U/D one-way clutch (F ₂)	★
	2. 2nd brake (B ₁)	★
Slip or shudder (3rd)	Direct clutch (C ₂)	★
Slip or shudder (O/D)	U/D clutch (C ₃)	★
No engine braking (1st - 3rd: D position)	U/D brake (B ₃)	★
No engine braking (1st: L position)	1st & reverse brake (B ₂)	★
No engine braking (2nd: 2 position)	2nd brake (B ₁)	★
Poor acceleration (All position)	1. Torque converter clutch	AX-36
	2. U/D planetary gear	★
Poor acceleration (O/D)	1. U/D clutch (C ₃)	★
	2. U/D planetary gear	★
Large shift shock or engine stalls when starting off or stopping	Torque converter clutch	AX-36

CIRCUIT INSPECTION

DW70-04

DTC	P0500	Vehicle Speed Sensor Malfunction
------------	--------------	-----------------------------------------

CIRCUIT DESCRIPTION

The vehicle speed sensor outputs a 4-pulse signal for every revolution of the transaxle output shaft. After this signal is converted into a more precise rectangular wave form by the wave form shaping circuit inside the combination meter, it is then transmitted to the ECM.

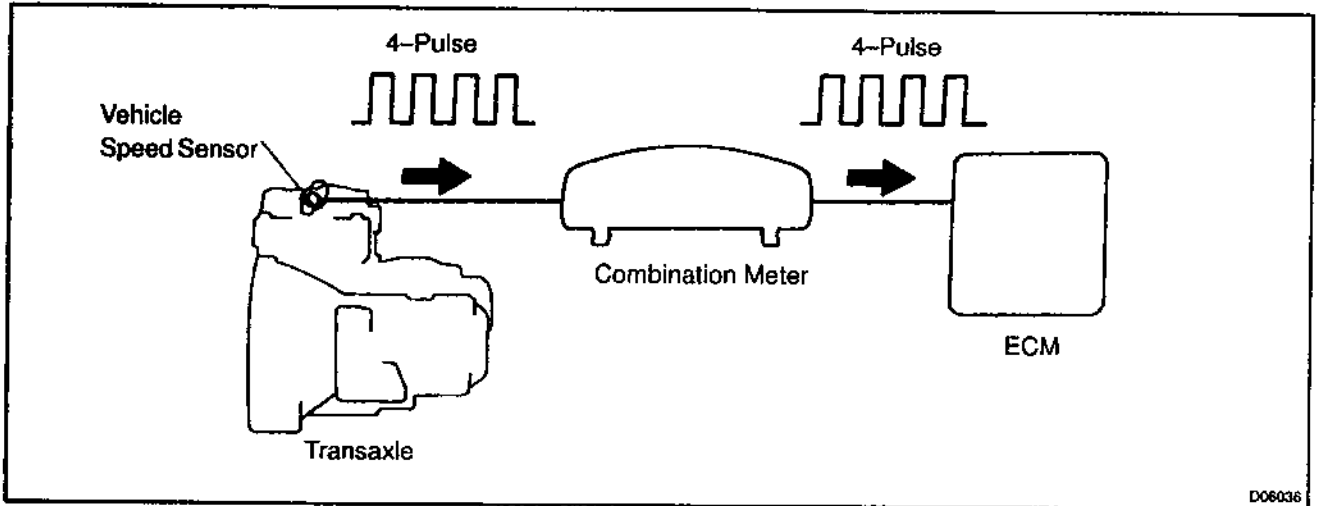

D06036

DTC No.	DTC Detecting Condition	Trouble Area
P0500	<p>When all of the following conditions continues for 1 sec. or more:</p> <ol style="list-style-type: none"> 1. After the ignition switch is turned on, 0.5 second or more elapses. 2. Counter gear rpm is equal to or greater than vehicle speed. 3. Vehicle speed sensor signal can not be input to the ECM. 4. The condition that engine coolant temp. is 20 °C or more (no error in engine coolant temp. sensor circuit is detected) and the park/neutral position switch is set to P or N continues for 2 for. or more, or the condition that engine coolant temp. is less than 20 °C (an error in engine coolant temp. sensor circuit is detected) and the park/neutral position switch is set to P or N continues for 30 sec. or more. 	<ul style="list-style-type: none"> • Combination meter • Open or short in vehicle speed sensor circuit • Vehicle speed sensor • ECM • Automatic transaxle (clutch, brake or gear etc.)
	Clutch or brake slips or gear is broken	

WIRING DIAGRAM

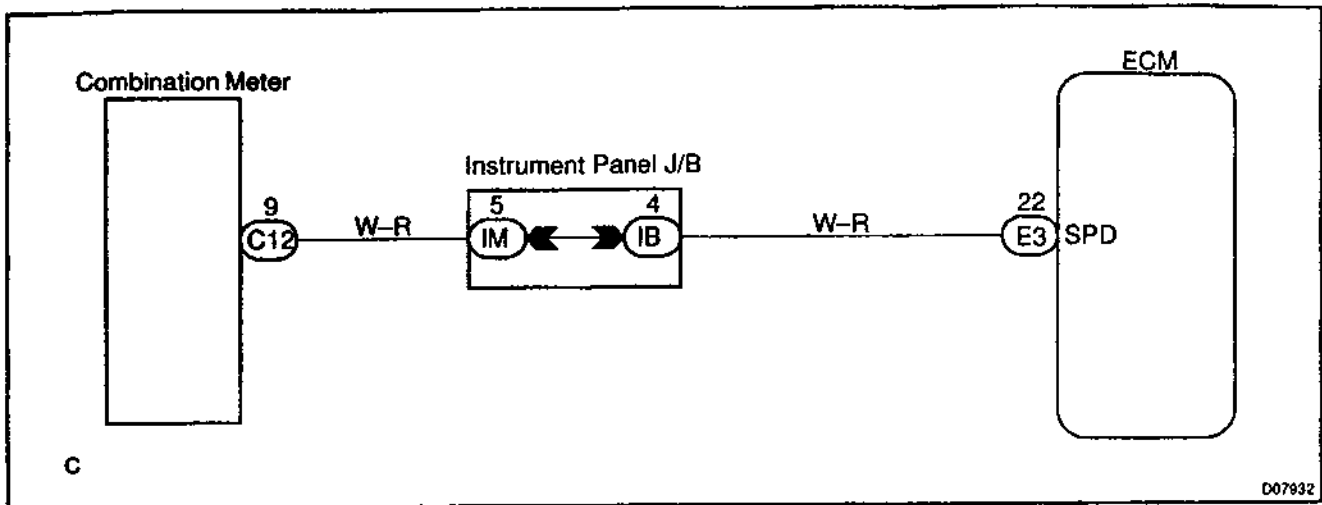

INSPECTION PROCEDURE

- | | |
|----------|----------------------------------------|
| 1 | Check operation of speedometer. |
|----------|----------------------------------------|

HINT:

Read freeze frame data using TOYOTA hand-held tester or OBD II scan tool. Because freeze frame records the engine conditions when the malfunction is detected. When troubleshooting it is useful for determining whether the vehicle was running or stopped, the engine was warmed up or not, the air-fuel ratio was lean or rich, etc. at the time of the malfunction.

CHECK:

Drive the vehicle and check if the operation of the speedometer in the combination meter is normal.

HINT:

The vehicle speed sensor is operating normally if the speedometer display is normal.

NG

Check speedometer (See page BE-2).

OK

- 2 Check for short in harness and connector between terminal SPD of ECM connector and body ground.**

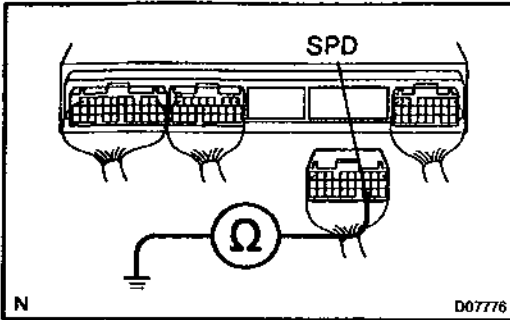
**PREPARATION:**

Disconnect the connector of the ECM.

CHECK:

Check continuity between terminal SPD of the ECM connector and body ground.

OK:

No continuity ($1M \Omega$ or higher)

NG

Repair or replace harness or connector.

OK

- 3 Check voltage between terminal SPD of ECM connector and body ground.**

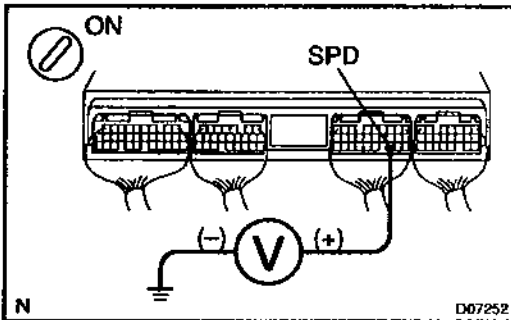
**PREPARATION:**

Turn ignition switch ON.

CHECK:

Measure voltage between terminal SPD of ECM connector and body ground.

OK:

Voltage: 9 – 14 V

NG

Check for open in harness and connector between J/B No. 1 and ECM (See page IN-30).

OK

- 4 Check for open in harness and connector between J/B No. 1 and combination meter (See page IN-30).**

NG

Repair or replace harness or connector.

OK

5	Check ECM (See page IN-20).
----------	------------------------------------

NG

Replace ECM.

OK

Check and repair transaxle (clutch, brake or gear etc.).

DTC	P0710	Transmission Fluid Temperature Sensor Malfunction (ATF Temperature Sensor)
------------	--------------	-----------------------------------------------------------------------------------

CIRCUIT DESCRIPTION

The ATF temperature sensor converts fluid temperature into a resistance value which is input into the ECM.

DTC No.	DTC Detecting Condition	Trouble Area
P0710	Either (a) or (b) is detected for 0.5 sec. or more. (1-trip detection logic) (a) Temp. sensor resistance is less than 79 Ω. (b) After the engine has been operating for 15 minutes or more, the resistance at the temp. sensor is more than 156 kΩ.	<ul style="list-style-type: none"> • Open or short in ATF temp. sensor • ATF temp. sensor • ECM

WIRING DIAGRAM

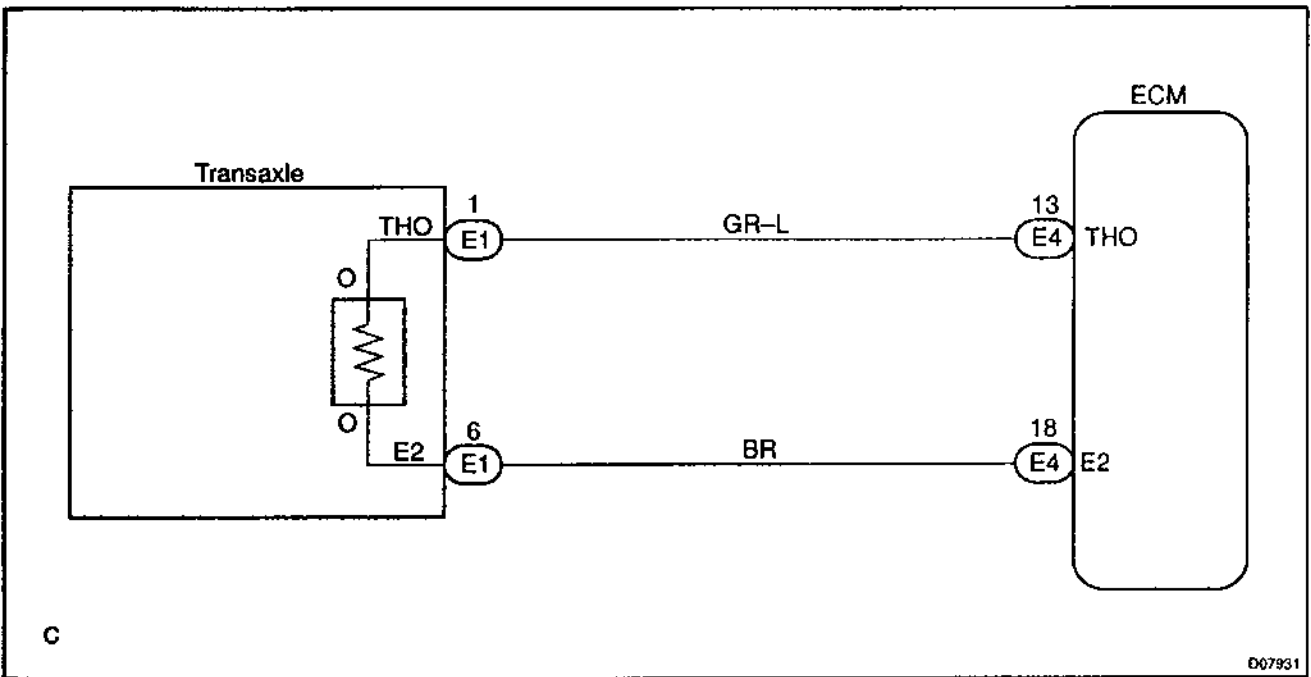

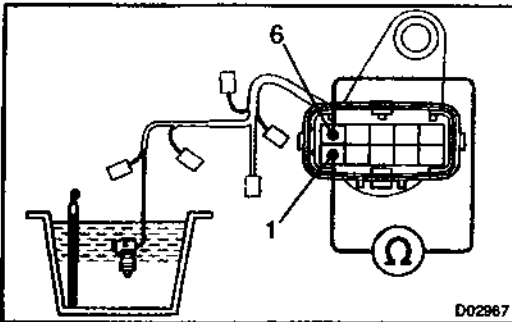
INSPECTION PROCEDURE**1 Check ATF temperature sensor.****PREPARATION:**

- (a) Disconnect the solenoid wire connector.
- (b) Remove the oil pan.
- (c) Disconnect all solenoid valve connectors.
- (d) Remove the transmission wire harness.

CHECK:

Measure resistance between terminals 1 and 6 of solenoid connector at 25 °C (77 °F) and 110 °C (230 °F).

OK:

Resistance (Approx.):

25 °C (77 °F): 3.5 kΩ

110 °C (230 °F): 231 – 263 Ω

NG

Replace the ATF temperature sensor (transmission wire).

OK**2 Check harness and connector between ATF temperature sensor and ECM (See page IN-30).****NG**

Repair or replace the harness or connector.

OK

Check and replace the ECM
(See page IN-30).

DTC	P0750	Shift Solenoid A Malfunction (Shift Solenoid Valve SL1)
------------	--------------	--------------------------------------------------------------------

DTC	P0755	Shift Solenoid B Malfunction (Shift Solenoid Valve SL2)
------------	--------------	--------------------------------------------------------------------

DTC	P0765	Shift Solenoid D Malfunction (Shift Solenoid Valve S4)
------------	--------------	-------------------------------------------------------------------

SYSTEM DESCRIPTION

The ECM uses signals from the vehicle speed sensor to detect the actual gear position (1st, 2nd, 3rd or O/D gear).

Then the ECM compares the actual gear with the shift schedule in the ECM memory to detect mechanical trouble of the shift solenoid valves and valve body.

DTC No.	DTC Detecting Condition	Trouble Area
P0750 P0755 P0765	During normal driving, the gear required by the ECM does not match the actual gear (2-trip detection logic)	<ul style="list-style-type: none"> • Shift solenoid valve SL1/SL2/S4 is stuck open or closed • Valve body is blocked up or stuck

HINT:

Check the shift solenoid valve SL1 when DTC P0750 is output, check the shift solenoid valve SL2 when DTC P0755 is output and check shift solenoid S4 when DTC P0765 is output.

INSPECTION PROCEDURE

1 Check shift solenoid valve SL1, SL2 or S4 operation.

Shift solenoid valve SL1 and SL2

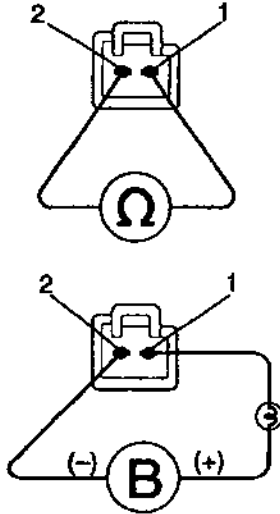

Shift solenoid valve S4

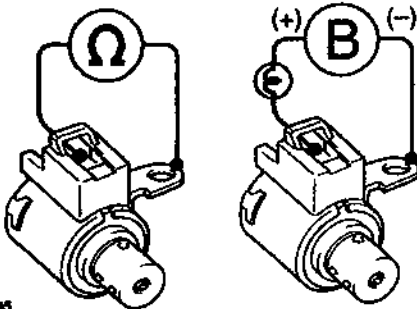

D03445
D03446
D03424 D03423

D03724

PREPARATION:

- (a) Jack up the vehicle.
- (b) Remove the oil pan.
- (c) Remove the shift solenoid valve SL1, SL2 or S4.

CHECK:**Check Solenoid Resistance:**

- (a) Shift solenoid valve SL1 or SL2:
Measure resistance between terminals 1 and 2 of solenoid connector.
- (b) Shift solenoid valve S4:
Measure resistance between terminal 1 of solenoid connector and solenoid body.

Check Solenoid Operation:

- (a) Shift solenoid valve SL1 or SL2:
Connect the positive (+) lead with an 23-W bulb to terminal 1 and the negative (-) lead to terminal 2 of solenoid connector, then check the movement of the valve.
- (b) Shift solenoid valve S4:
Connect the positive (+) lead with an 23-W bulb to terminal 1 of solenoid connector and the negative (-) lead to the solenoid valve body, then check the movement of the valve.

OK:

- (a) Resistance: 5.1 – 5.5 Ω
- (b) The shift solenoid valve makes operation noise.

NG

Replace the shift solenoid valve SL1, SL2 or S4.

OK

Check the valve body (See page DI-172).

DTC	P0753	Shift Solenoid A Electrical Malfunction (Shift Solenoid Valve SL1)
------------	--------------	-------------------------------------------------------------------------------

DTC	P0758	Shift Solenoid B Electrical Malfunction (Shift Solenoid Valve SL2)
------------	--------------	-------------------------------------------------------------------------------

DTC	P0768	Shift Solenoid D Electrical Malfunction (Shift Solenoid Valve S4)
------------	--------------	------------------------------------------------------------------------------

CIRCUIT DESCRIPTION

Shifting from 1st to O/D is performed in combination with ON and OFF of the shift solenoid valves SL1 and SL2 controlled by ECM. If an open or short circuit occurs in either of the shift solenoid valves, the ECM controls the remaining normal shift solenoid valve to allow the vehicle to be operated smoothly (Fail safe function).

DTC No.	DTC Detecting Condition	Trouble Area
P0753 P0758	The ECM checks for an open or short circuit in the shift solenoid valves SL1 and SL2. (a) When the solenoid is energized, the duty ratio exceed 75 %. (b) When the solenoid is not energized, the duty ratio is less than 3 %.	<ul style="list-style-type: none"> • Open or short in shift solenoid valve SL1/SL2/S4 circuit • Shift solenoid valve SL1/SL2/S4 • ECM
P0768	The ECM checks for an open or short circuit in the shift solenoid valve S4 circuit when it changes. The ECM records DTC P0768 if condition (a) or (b) is detected. (a) When the solenoid is energized, the solenoid resistance is 8 Ω or less and is counted. (b) When the solenoid is not energized, the solenoid resistance is 100 k Ω or more and is counted.	

HINT:

Check the shift solenoid valve SL1 when DTC P0753 is output, check the shift solenoid valve SL2 when DTC P0758 is output and check the shift solenoid valve S4 when DTC P0768 is output.

Fail safe function:

If either of the shift solenoid valve circuits develops an open or short, the ECM turns the other shift solenoid ON and OFF to shift to the gear positions shown in the table below. The ECM also turns the shift solenoid valve DSL OFF at the same time. If both solenoids are malfunction, hydraulic control cannot be performed electronically and must be done manually.

Manual shifting as shown in the following table must be done (In the case of a short circuit, the ECM stops sending current to the short circuited solenoid).

NORMAL				SHIFT SOLENOID SL1 MALFUNCTIONING						SHIFT SOLENOID SL2 MALFUNCTIONING					
				Driving at 3rd or O/D			Driving at 1st or 2nd								
Solenoid Valve			Gear	Solenoid Valve			Gear	Solenoid Valve			Gear	Solenoid Valve			Gear
SL1	SL2	S4		SL1	SL2	S4		SL1	SL2	S4		SL1	SL2	S4	
ON	ON	OFF	1st	X	ON ↓ OFF	OFF	3rd	X	ON	OFF	2nd	ON ↓ OFF	X	OFF	3rd
OFF	ON	OFF	2nd	X	ON ↓ OFF	OFF	3rd	X	ON	OFF	2nd	OFF	X	OFF	3rd
	OFF	OFF	3rd	X	OFF	OFF	3rd	X	OFF ↓ ON	OFF ↓ ON	3rd		X	OFF	3rd
	OFF	ON	O/D	X	OFF	ON	O/D	X	OFF ↓ ON	ON	3rd		X	ON	O/D

SHIFT SOLENOID S4 MALFUNCTIONING				SHIFT SOLENOID SL1 AND SL2 MALFUNCTIONING				SHIFT SOLENOID SL1 AND S4 MALFUNCTIONING							
								Driving at 3rd or O/D				Driving at 1st or 2nd			
Solenoid Valve			Gear	Solenoid Valve			Gear	Solenoid Valve			Gear	Solenoid Valve			Gear
SL1	SL2	S4		SL1	SL2	S4		SL1	SL2	S4		SL1	SL2	S4	
ON	ON	X	1st	X	X	OFF	3rd	X	ON ↓ OFF	X	3rd	X	ON	X	2nd
OFF	ON	X	2nd	X	X	OFF	3rd	X	ON ↓ OFF	X	3rd	X	ON	X	2nd
	OFF	X	3rd	X	X	OFF	3rd	X	OFF	X	3rd	X	OFF ↓ ON	X	2nd
	OFF	X	3rd	X	X	ON	O/D	X	OFF	X	3rd	X	OFF ↓ ON	X	2nd

SHIFT SOLENOID SL2 AND S4 MALFUNCTIONING				SHIFT SOLENOID SL1, SL2 AND S4 MALFUNCTIONING			
Solenoid Valve			Gear	Solenoid Valve			Gear
SL1	SL2	S4		SL1	SL2	S4	
ON ↓ OFF	X	X	3rd	X	X	X	3rd
OFF	X	X	3rd	X	X	X	3rd
	X	X	3rd	X	X	X	3rd
	X	X	3rd	X	X	X	3rd

WIRING DIAGRAM

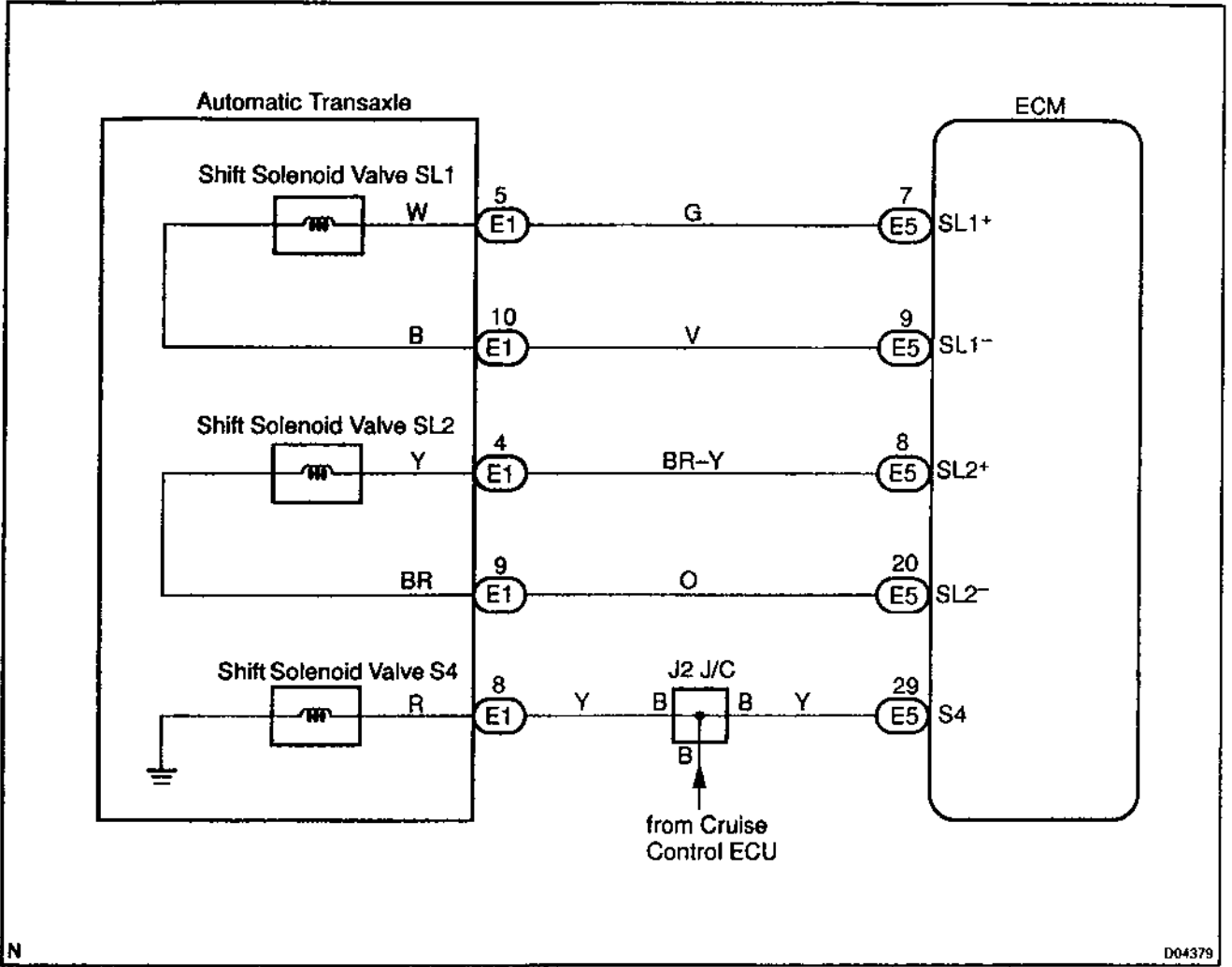

INSPECTION PROCEDURE

1 Measure resistance between terminals of ECM.

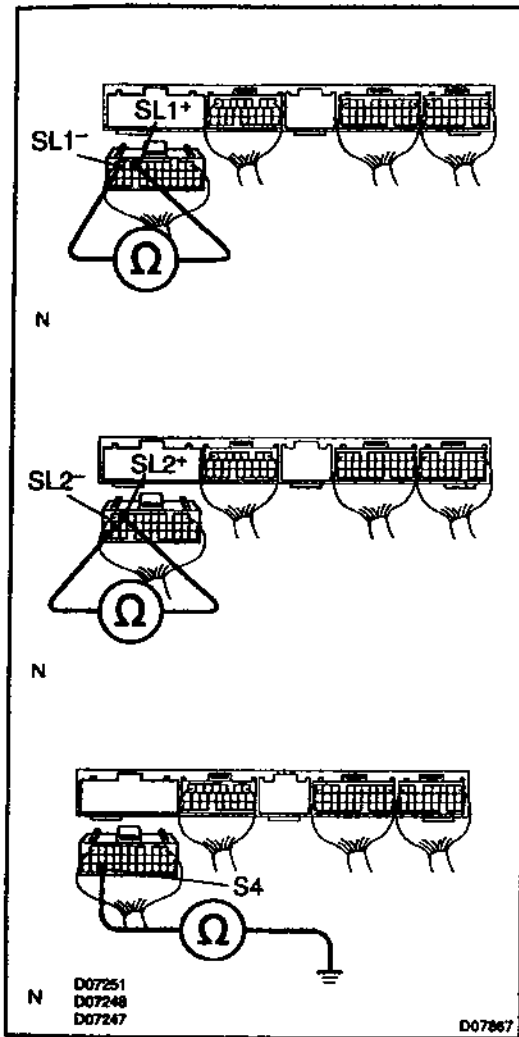
**PREPARATION:**

Disconnect the connector from ECM.

CHECK:

- Measure resistance between terminals SL1⁺ and SL1⁻ of ECM connector.
- Measure resistance between terminals SL2⁺ and SL2⁻ of ECM connector.
- Measure resistance between terminal S4 of ECM connector and body ground.

OK:**Resistance:**

- SL1⁺ - SL1⁻: $5.3 \pm 0.2 \Omega$
- SL2⁺ - SL2⁻: $5.3 \pm 0.2 \Omega$
- S4 - Body ground: $13 \pm 2 \Omega$

OK

Check and replace the ECM.

NG

2 Measure harness and connector between ECM and automatic transaxle solenoid connector.

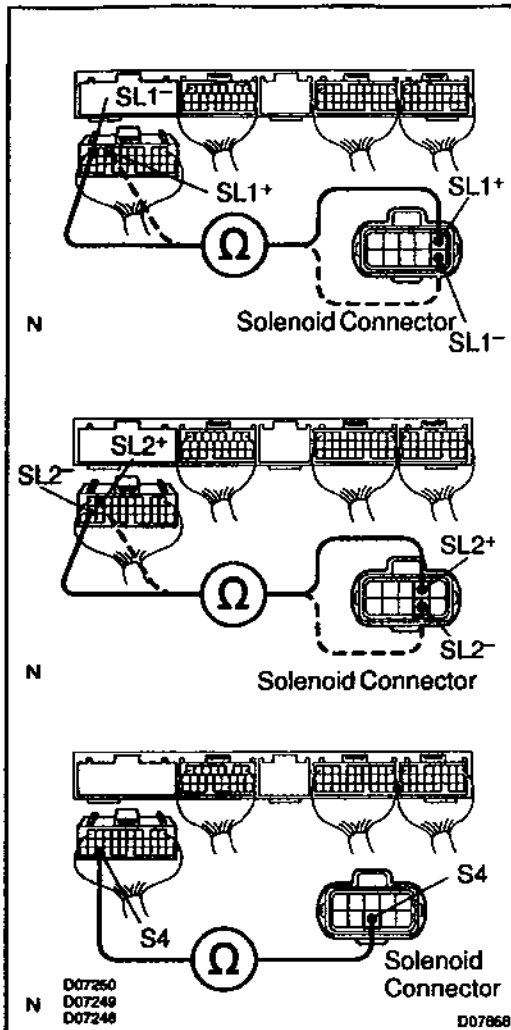

PREPARATION:

- Disconnect the solenoid connector from the automatic transaxle.
- Disconnect the connector from the ECM.

CHECK:

- Measure the harness and connector between terminal SL1⁺ or SL1⁻ of ECM and terminal SL1⁺ or SL1⁻ of solenoid connector.
- Measure the harness and connector between terminal SL2⁺ or SL2⁻ of ECM and terminal SL2⁺ or SL2⁻ of solenoid connector.
- Measure the harness and connector between terminal S4 of ECM and terminal S4 of solenoid connector.

OK:

Resistance: 0 Ω

OK

NG

Repair or replace the harness or connector.

3**Check shift solenoid valve SL1, SL2 or S4 (See page DI-181).****NG****Replace the solenoid valve.****OK****Repair or replace the solenoid wire, harness and connector between ECM and automatic transaxle solenoid connector.**

DTC	P0770	Shift Solenoid E Malfunction (Shift Solenoid Valve DSL)
------------	--------------	--------------------------------------------------------------------

SYSTEM DESCRIPTION

The ECM uses the signals from the throttle position sensor, air-flow meter and crankshaft position sensor to monitor the engagement condition of the lock-up clutch.

Then the ECM compares the engagement condition of the lock-up clutch with the lock-up schedule in the ECM memory to detect mechanical trouble of the shift solenoid valve DSL, valve body and torque converter clutch.

DTC No.	DTC Detecting Condition	Trouble Area
P0770	Lock-up does not occur when driving in the lock-up range (normal driving at 80 km/h [50 mph]), or lock-up remains ON in the lock-up OFF range. (2-trip detection logic)	<ul style="list-style-type: none"> • Shift solenoid valve DSL is stuck open or closed • Valve body blocked up or stuck • Lock-up clutch

INSPECTION PROCEDURE

1	Check solenoid valve DSL operation.
----------	--------------------------------------------

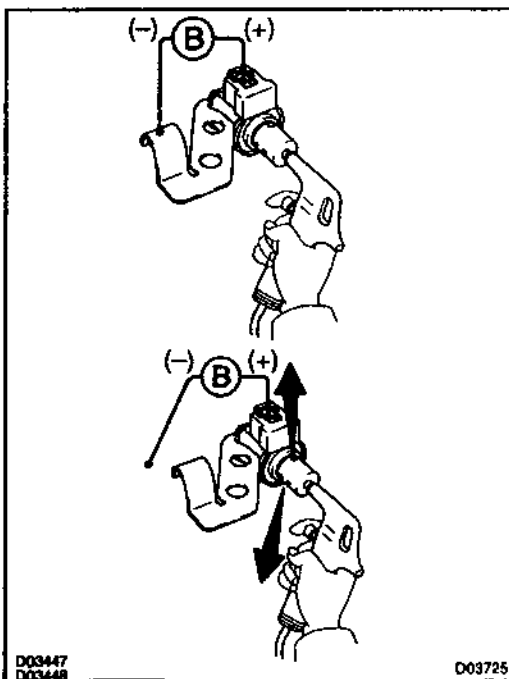

PREPARATION:

- (a) Remove the oil pan.
- (b) Remove the shift solenoid valve DSL.

CHECK:

- (a) Applying 490 kPa (5 kgf/cm², 71 psi) of compressed air, check that the solenoid valve does not leak air.
- (b) When battery positive voltage is supplied to the shift solenoid valve, check that the solenoid valve opens.

OK:

- (a) Solenoid valve does not leak air.
- (b) Solenoid valve opens.

NG

Replace the solenoid valve DSL.

OK

2	Check valve body (See page DI-172).
---	-------------------------------------

NG	Repair or replace the valve body.
----	-----------------------------------

OK

Replace the torque converter clutch
(See page AX-30).

DTC	P0773	Shift Solenoid E Electrical Malfunction (Shift Solenoid Valve DSL)
------------	--------------	-------------------------------------------------------------------------------

CIRCUIT DESCRIPTION

The shift solenoid valve DSL is turned ON and OFF by signals from the ECM to control the hydraulic pressure acting on the lock-up relay valve, which then controls operation of the lock-up clutch.

DTC No.	DTC Detecting Condition	Trouble Area
P0773	Either (a) or (b) are detected for 1 time. (2-trip detection logic) (a) Solenoid resistance is 8 Ω or less short circuit when solenoid is energized. (b) Solenoid resistance is 100 kΩ or more open circuit when solenoid is not energized.	<ul style="list-style-type: none"> • Open or short in shift solenoid valve DSL circuit • Shift solenoid valve DSL • ECM

Fail safe function:

If the ECM detects a malfunction, it turns the shift solenoid valve DSL OFF.

WIRING DIAGRAM

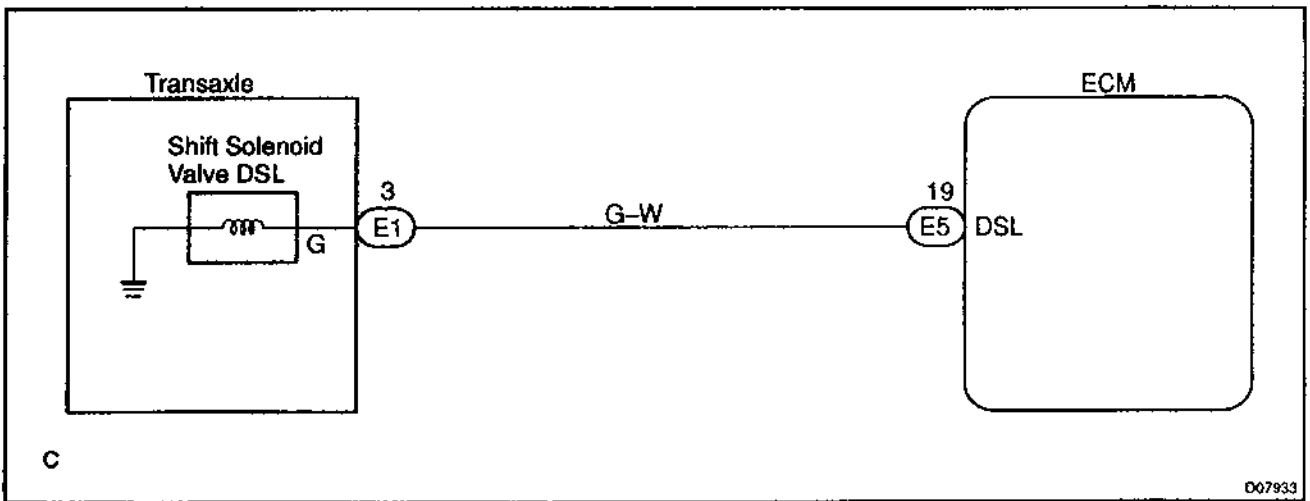

INSPECTION PROCEDURE

- 1 Check harness and connector between ECM and automatic transaxle solenoid connector.

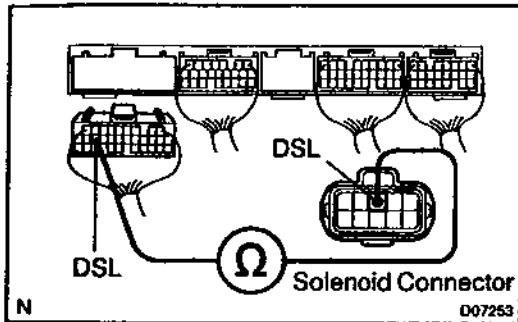

PREPARATION:

- Disconnect the solenoid connector from the transaxle.
- Disconnect the connector from the ECM.

CHECK:

Measure the harness and connector between terminal DSL of ECM and terminal DSL of solenoid connector.

OK:

There is continuity.

NG

Repair or replace the harness or connector.

OK

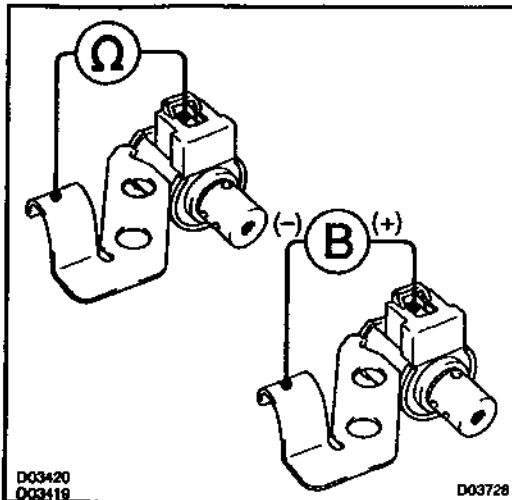
2 Check shift solenoid valve DSL.

PREPARATION:

- (a) Jack up the vehicle.
- (b) Remove the oil pan.
- (c) Disconnect the shift solenoid valve DSL connector.
- (d) Remove the shift solenoid valve DSL.

CHECK:

- (a) Measure resistance between terminal DSL of shift solenoid valve and solenoid body.
- (b) Connect positive (+) lead to terminal of solenoid connector, negative (-) lead to solenoid body.

OK:

- (a) **Resistance: 11 – 15 Ω**
- (b) **The shift solenoid valve DSL makes operation noise.**

NG
Replace the shift solenoid valve DSL.
OK
Check and replace or repair the solenoid wire.

DTC	P1520	Stop Light Switch Signal Malfunction
------------	--------------	---------------------------------------------

CIRCUIT DESCRIPTION

The purpose of this circuit is to prevent the engine from stalling, while driving in lock-up condition, when brakes are suddenly applied.

When the brake pedal is operated, this switch sends a signals to ECM. Then the ECM cancels operation of the lock-up clutch while braking is in progress.

DTC No.	DTC Detecting Condition	Trouble Area
P1520	No stop light switch signal to ECM during driving. (2-trip detection logic)	<ul style="list-style-type: none"> • Open or short in stop light switch circuit • Stop light switch • ECM

WIRING DIAGRAM

See page DI-130.

INSPECTION PROCEDURE

See page DI-130.

DTC	P1725	NT Revolution Sensor Circuit Malfunction (Input Turbine Speed Sensor)
------------	--------------	----------------------------------------------------------------------------------

CIRCUIT DESCRIPTION

This sensor detects the rotation speed of the input turbine. By comparing the input turbine speed signal (NT) and the counter gear speed sensor signal (NC), the ECM detects the shift timing of the gears and appropriately controls the engine torque and hydraulic pressure in response to various conditions, thus performing smooth gear shifting.

DTC No.	DTC Detecting Condition	Trouble Area
P1725	<p>The ECM detects conditions (a), (b), (c), (d) and (e) continuity for 5 seconds or more. (1-trip detection logic)</p> <p>(a) Gear change not being performed (b) Gear position: 2nd, 3rd or O/D gear (c) Solenoid valves and park/neutral position switch are normal (d) T/M input shaft rpm: 300 rpm or less (e) T/M output shaft rpm: 1,000 rpm or less</p> <p>(a) Gear change not being performed (b) Gear position: 2nd, 3rd or O/D gear (c) Solenoid valves and park/neutral position switch are normal (d) T/M input shaft rpm: 300 rpm or less (e) T/M output shaft rpm: 1,000 rpm or less</p>	<ul style="list-style-type: none"> • Open or short in input turbine (NT) speed sensor circuit • Input turbine (NT) speed sensor • ECM

WIRING DIAGRAM

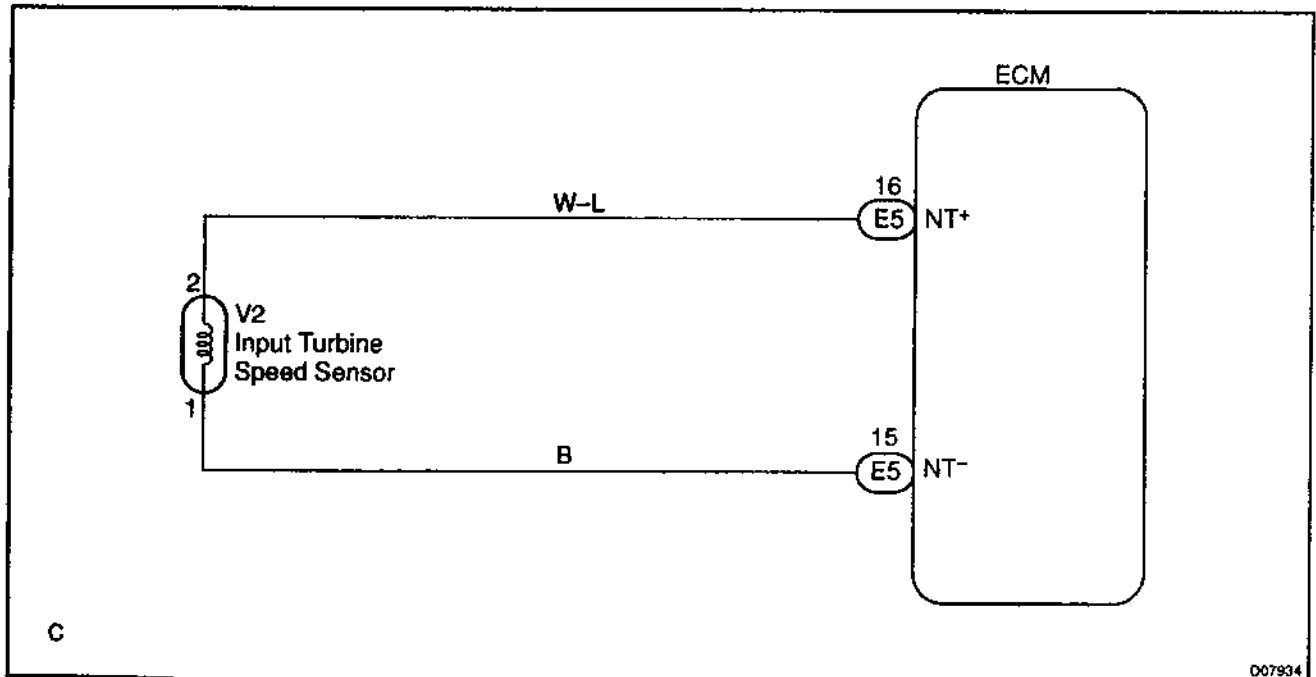

INSPECTION PROCEDURE

- 1** Check resistance between terminals NT⁺ and NT⁻ of ECM.

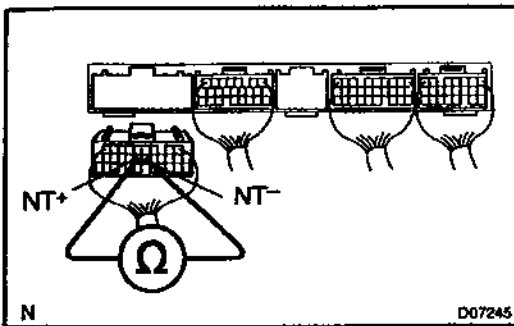
**PREPARATION:**

Disconnect the connector from ECM.

CHECK:

Check resistance between terminals NT⁺ and NT⁻ of ECM.

OK:

Resistance: $620 \pm 60 \Omega$

OK

Check and replace the ECM
(See page IN-30).

NG

- 2** Check NT revolution speed sensor.

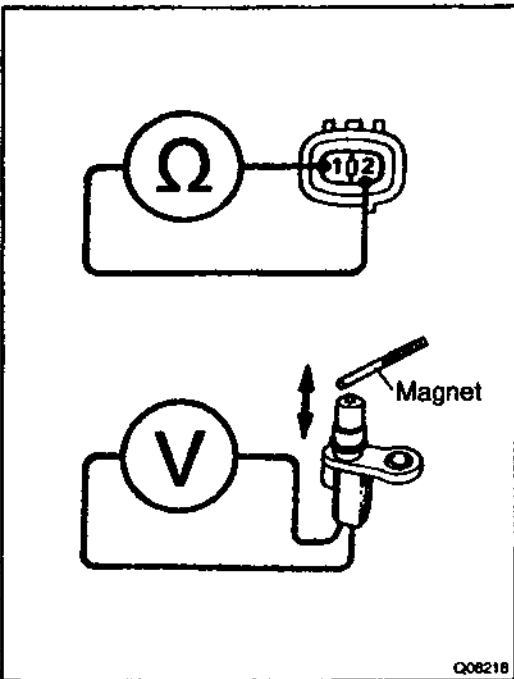
**PREPARATION:**

Remove the NT revolution speed sensor from transaxle.

CHECK:

- Measure resistance between terminals 1 and 2 of speed sensor.
- Check voltage between terminals 1 and 2 of the speed sensor when a magnet is put close to the front end of the speed sensor then taken away quickly.

OK:

(a) Resistance: $620 \pm 60 \Omega$ at 20 °C (68 °F)

(b) Voltage is generated Intermittently.

HINT:

The voltage generated is extremely low.

NG

Replace the NT revolution speed sensor.

OK

Check and repair the harness and connector between ECM and NT revolution speed sensor (See page IN-30).

DTC	P1730	NC Revolution Sensor Circuit Malfunction (Counter Gear Speed Sensor)
------------	--------------	---------------------------------------------------------------------------------

CIRCUIT DESCRIPTION

This sensor detects the rotation speed of the counter gear. By comparing the counter gear speed signal (NC) and the input turbine speed sensor signal (NT), the ECM detects the shift timing of the gears and appropriately controls the engine torque and hydraulic pressure in response to various conditions, thus performing smooth gear shifting.

DTC No.	DTC Detecting Condition	Trouble Area
P1730	The ECM detects conditions (a), (b), (c) and (d) continuity for 5 secs or more. (1-trip detection logic) (a) IG SW: ON (b) Park/neutral position switch: Except P, N position (c) T/M input shaft rpm: 300 rpm or less (d) T/M output shaft rpm: 1,000 rpm or more	<ul style="list-style-type: none"> • Open or short in NC revolution sensor circuit • NC revolution speed sensor • ECM

WIRING DIAGRAM

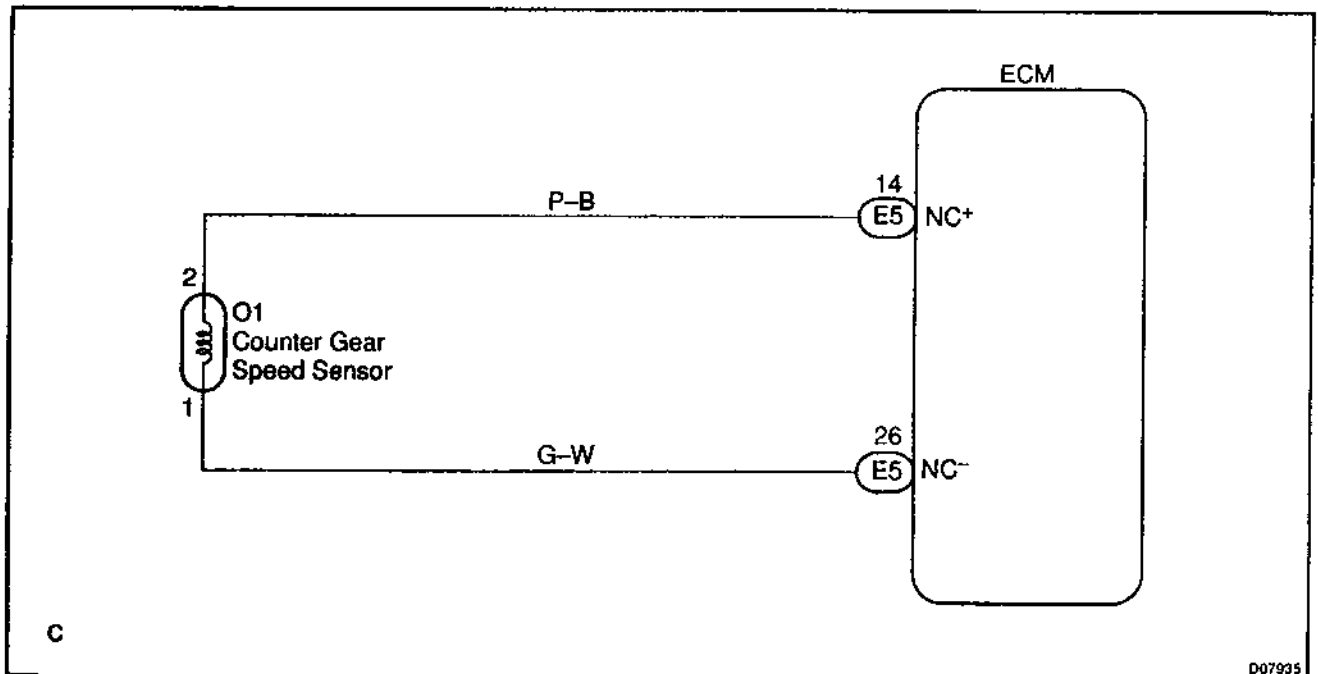

INSPECTION PROCEDURE

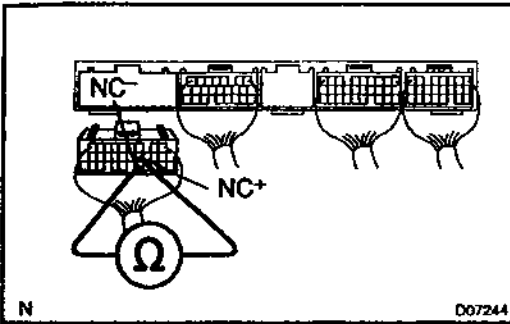
1 Check resistance between terminals NC⁺ and NC⁻ of ECM.**PREPARATION:**

Disconnect the connector from ECM.

CHECK:

Check resistance between terminals NC⁺ and NC⁻ of ECM.

OK:

Resistance: $620 \pm 60 \Omega$

OK

Check and replace the ECM
(See page IN-30).

NG

2 Check NC revolution speed sensor.

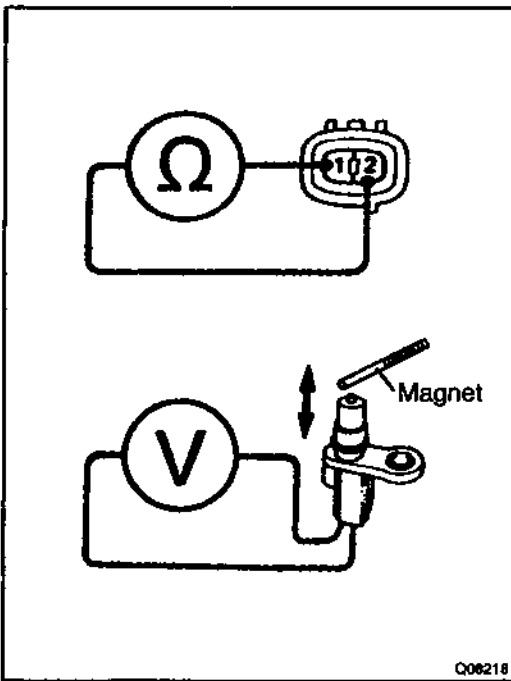
**PREPARATION:**

Remove the NC revolution speed sensor from transaxle.

CHECK:

- Measure resistance between terminals 1 and 2 of speed sensor.
- Check voltage between terminals 1 and 2 of the speed sensor when a magnet is put close to the front end of the speed sensor then taken away quickly.

OK:

(a) Resistance: $620 \pm 60 \Omega$ at 20°C (68°F)

(b) Voltage is generated intermittently.

HINT:

The voltage generated is extremely low.

NG

Replace the NC revolution speed sensor.

OK

Check and repair the harness and connector
between ECM and NC revolution speed sensor
(See page IN-30).

DTC	P1760	Linear Solenoid for Line Pressure Control Circuit Malfunction (Solenoid Valve SLT)
------------	--------------	-------------------------------------------------------------------------------------------

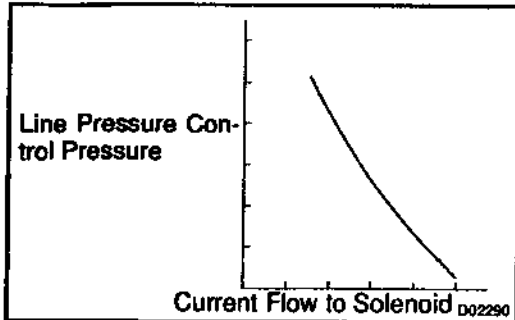

CIRCUIT DESCRIPTION

The throttle pressure that is applied to the primary regulator valve (which modulates line pressure) causes the solenoid valve SLT, under electronic control, to precisely and minutely modulate and generate line pressure according to the accelerator pedal effort, or engine power output detected.

This reduces the function of line pressure and provides smooth shifting characteristics.

Upon receiving the throttle valve opening angle signal, ECM controls the line pressure by sending a predetermined (*) duty ratio to the solenoid valve, modulating the line pressure, generating throttle pressure.

(*) Duty Ratio

The duty ratio is the ratio of the period of continuity in one cycle. For example, if "A" is the period of continuity in one cycle, and "B" is the period of non-continuity, then

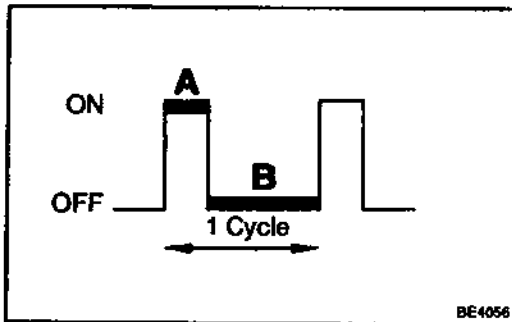

$$\text{Duty Ratio} = \frac{A}{A + B} \times 100 (\%)$$

DTC No.	DTC Detecting Condition	Trouble Area
P1760	(a) or (b) condition below is detected 1 second or more. (a) SLT ⁻ terminal: 0V (b) SLT ⁻ terminal: 12V	<ul style="list-style-type: none"> • Open or short in shift solenoid valve SLT circuit • Shift solenoid valve SLT • ECM

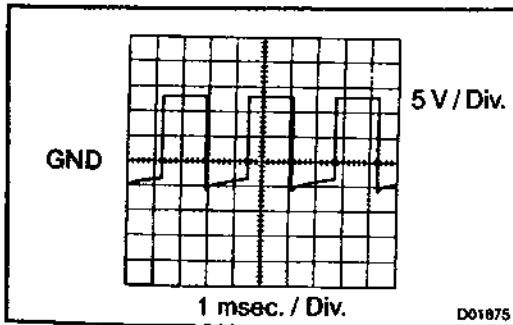

Reference:

Wave form between terminals SLT⁺ and SLT⁻ during engine idling.

WIRING DIAGRAM

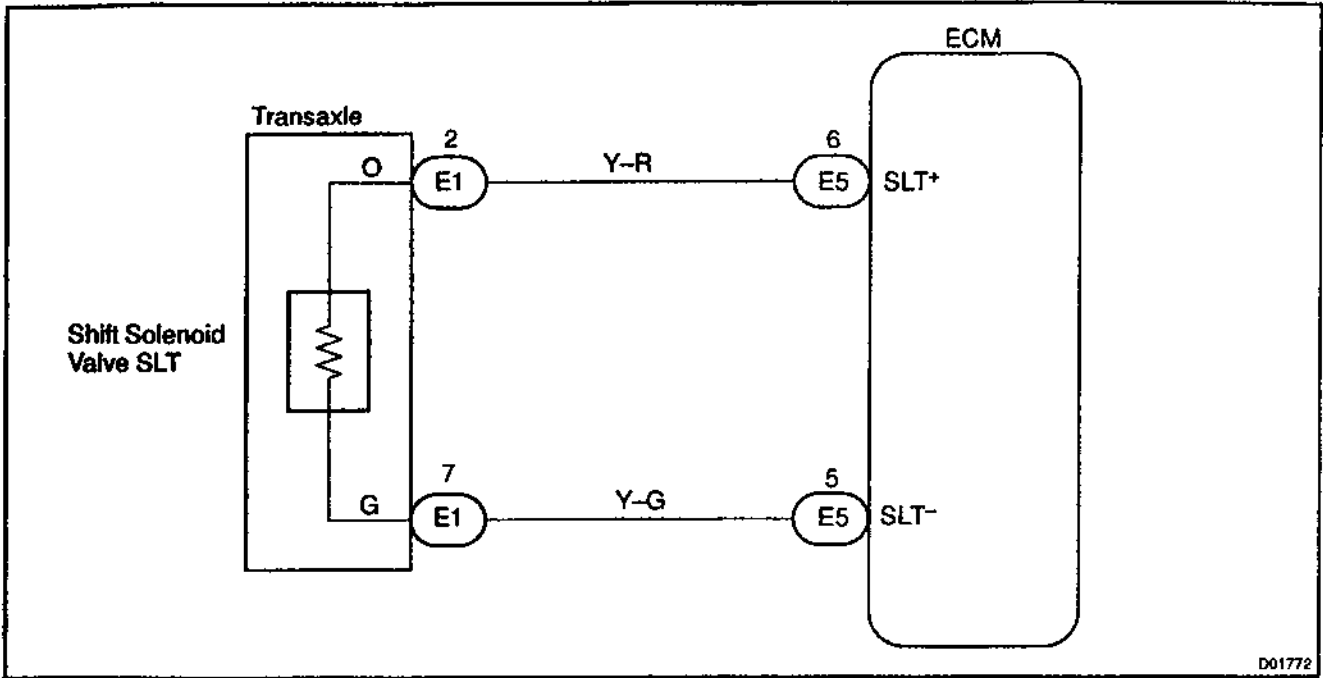

INSPECTION PROCEDURE

1 Check shift solenoid valve SLT.

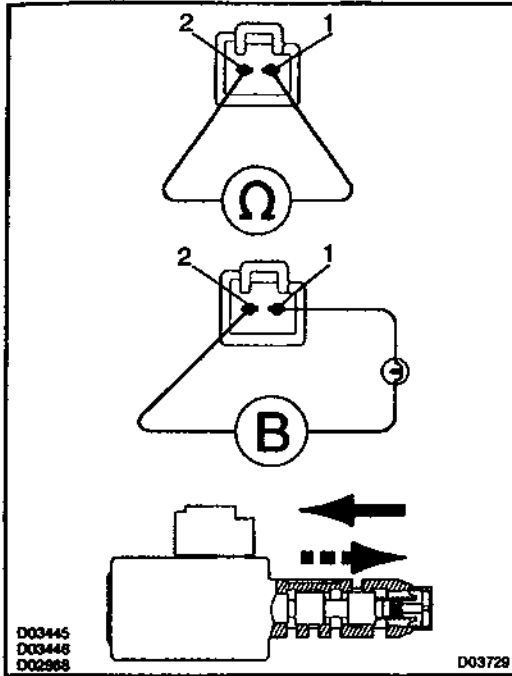

PREPARATION:

- (a) Jack up the vehicle.
- (b) Remove the oil pan.
- (c) Disconnect the solenoid connector.

Check solenoid resistance:

CHECK:

Measure resistance between terminals 1 and 2 of solenoid connector.

OK:

Resistance: 5.0 – 5.6 Ω

Check solenoid operation:

CHECK:

Connect positive (+) lead with an 8 – 10W bulb to terminal 1 of solenoid connector and negative (-) lead to terminal 2, then check the movement of the valve.

OK:

When battery positive voltage is applied.	Valve moves in direction in illustration at right.
When battery positive voltage is cut off.	Valve moves in direction in illustration at left.

NG Replace shift solenoid valve SLT.

OK

2 Check harness and connector between shift solenoid valve SLT and ECM (See page IN-30).

NG Repair or replace harness or connector.

OK

Replace ECM.

DTC	P1780	Park/Neutral Position Switch Malfunction
------------	--------------	-------------------------------------------------

CIRCUIT DESCRIPTION

The park/neutral position switch detects the shift lever position and sends signals to the ECM. The ECM receives signals (R, R, N, D 2 and L) from the park/neutral position switch.

DTC No.	DTC Detection Condition	Trouble Area
P1780	When more than one of the following conditions continue for 500 sec. or more. (a) P, N position input signal is ON. (b) P position input signal is ON. (c) N position input signal is ON. (d) L position input signal is ON. (e) 2 position input signal is ON. (f) 3 position input signal is ON. (g) 4 position input signal is ON. (h) D position input signal is ON. (i) R position input signal is ON.	<ul style="list-style-type: none"> • Short in park/neutral position switch circuit • Park/neutral position switch • ECM
	When any of following conditions for 500 msec. or more in the M position. (a) P, N position input signal is ON. (b) P position input signal is ON. (c) N position input signal is ON. (d) L position input signal is ON.	

WIRING DIAGRAM

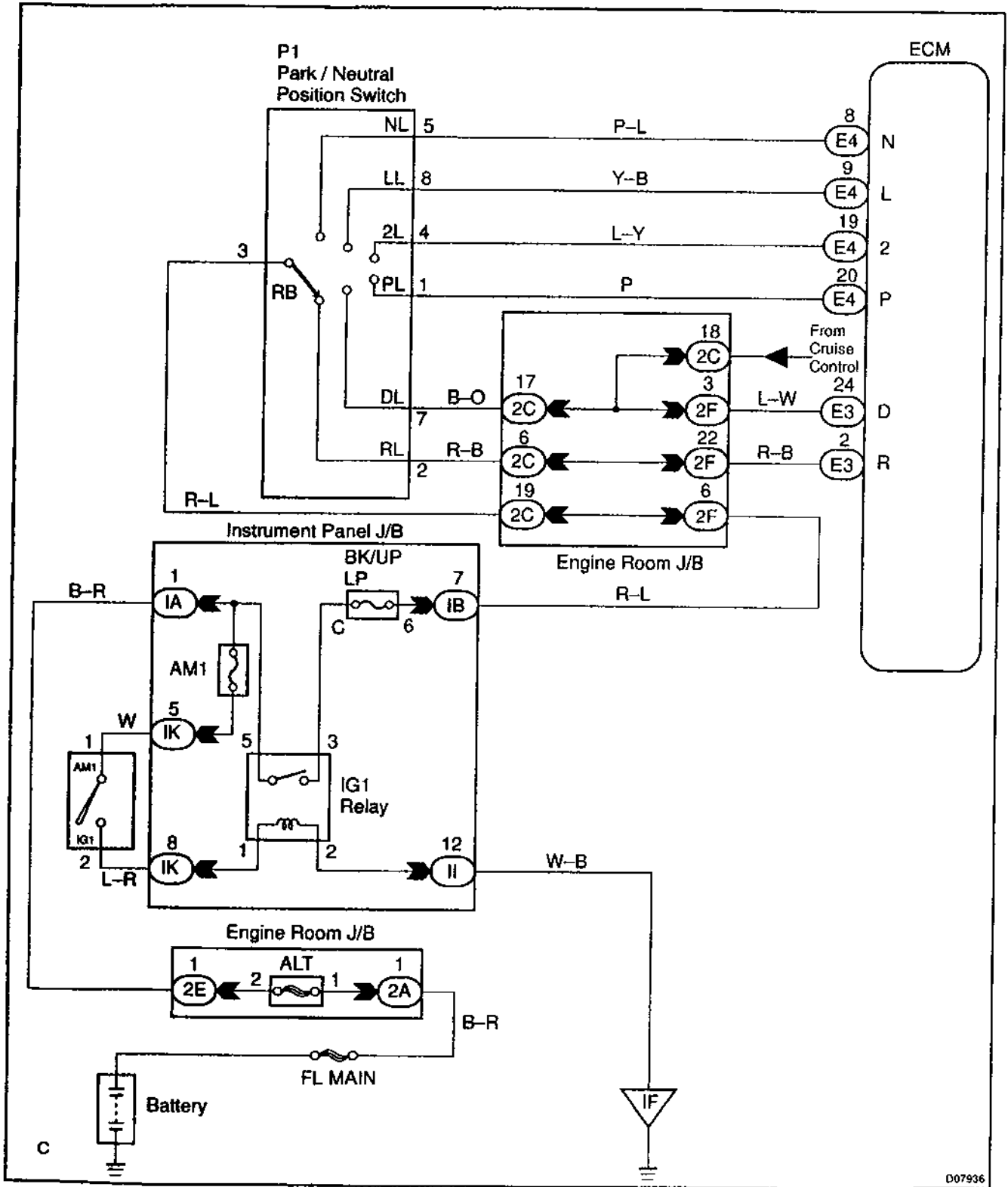

INSPECTION PROCEDURE

1	Read PNP, REVERSE, 2ND and LOW signals.
----------	------------------------------------------------

When using TOYOTA hand-held tester:

PREPARATION:

- (a) Remove the DLC3 cover.
- (b) Connect a TOYOTA hand-held tester to the DLC3.
- (c) Turn the ignition switch ON and TOYOTA hand-held tester main switch ON.

CHECK:

Shift lever into the P, R, N, D, 2 and L positions, and read the NSW, REVERSE, 2ND DRIVE and LOW signals on the TOYOTA hand-held tester.

OK:

Shift position	Signal
2	2ND OFF → ON
L	LOW OFF → ON
D	DRIVE OFF → ON
R	REVERSE OFF → ON
P, N	NSW OFF → ON

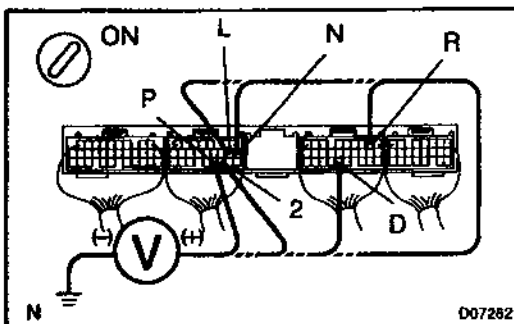

When not using TOYOTA hand-held tester:

PREPARATION:

Turn the ignition switch ON.

CHECK:

Measure voltage between terminals P, R, N, D, 2 and L of ECM and body ground when the shift lever is shifted to the following positions.

OK:

Position	P-Body ground	R-Body ground	N-Body ground	D-Body ground	2-Body ground	L-Body ground
P	9-14 V	0 V	0 V	0 V	0 V	0 V
R	0 V	9-14 V	0 V	0 V	0 V	0 V
N	0 V	0 V	9-14 V	0 V	0 V	0 V
D	0 V	0 V	0 V	9-14 V	0 V	0 V
2	0 V	0 V	0 V	0 V	9-14 V	0 V
L	0 V	0 V	0 V	0 V	0 V	9-14 V

HINT:

*: The voltage will drop slightly due to lighting up of the back up light.

OK

Check and replace the ECM (See page IN-30).

NG

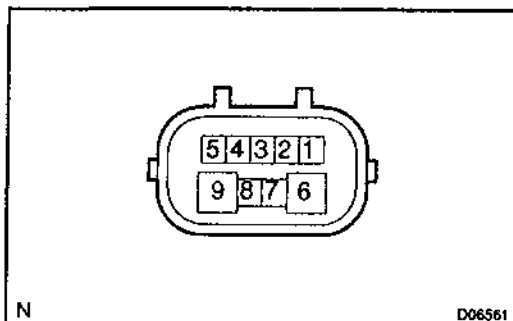
2 Check park/neutral position switch.**PREPARATION:**

- (a) Jack up the vehicle.
 (b) Remove the park/neutral position switch.

CHECK:

Check continuity between each terminal shown below when the shift lever is moved to each position.

Shift position	Terminal No. to continuity	
P	6-9	1-3
R	2-3	-
N	6-9	3-5
D	3-7	-
2	3-4	-
L	3-8	-

OK:

There is continuity.

NG

Replace the park/neutral position switch.

OK

Repair or replace harness and connector between battery and park/neutral position switch, park/neutral position switch and ECM (See page IN-30).

INSPECTION PROCEDURE

1 Check operation of O/D main switch

PREPARATION:

Turn the ignition switch ON.

CHECK:

- (a) Check O/D OFF indicator light when O/D main switch is pushed in to ON.
- (b) Check O/D OFF indicator light when O/D main switch is pushed again.

OK:

- (a) O/D OFF indicator light lights up.
- (b) O/D OFF indicator light goes off.

OK Proceed to next inspection shown on problem symptoms tables (See page DI-172).

NG

2 Check and replace the combination meter (See page BE-2).

NG Replace the combination meter.

OK

3 Check O/D main switch.

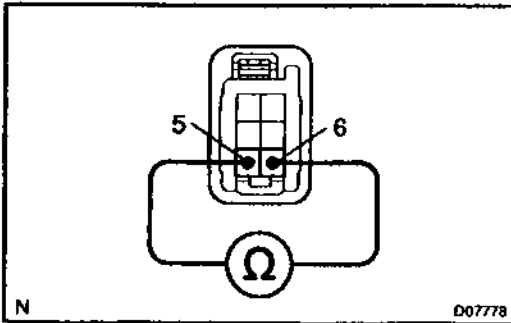

PREPARATION:

Disconnect the O/D main switch connector.

CHECK:

Check continuity between terminals 5 and 6 of O/D main switch connector.

OK:

O/D main switch condition	Specified condition
Press continuously O/D main switch	Continuity
Release O/D main switch	No continuity

NG Replace and repair O/D main switch.

OK

4 Check voltage between terminal ODMS of ECM and body ground.

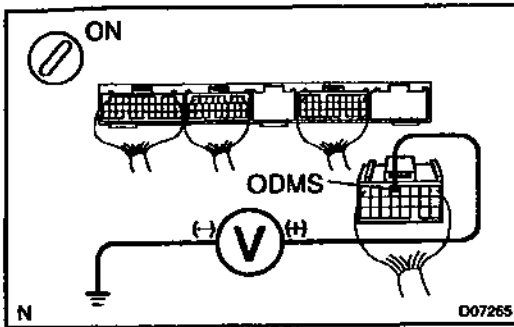
**PREPARATION:**

Turn the ignition switch ON.

CHECK:

Check voltage between terminal ODMS of ECM and body ground when O/D main switch is ON and OFF.

OK:

O/D main switch	Specified voltage
Press continuously O/D main switch	Below 1.0 V
Release O/D main switch	10 ~ 14 V

OK

Check and replace the ECM (See page IN-20).

NG

5 Check voltage between terminal ODLP of ECM and body ground.

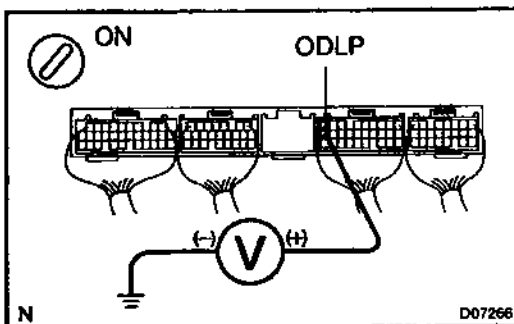
**PREPARATION:**

(a) Disconnect the connector of ECM.

(b) Turn the ignition switch ON.

CHECK:

Check voltage between terminal ODLP of ECM and body ground.

OK:

Voltage: 7.5 - 14 V

OK

Check and replace the ECM (See page IN-20).

NG

Check and replace harness and connector between combination meter and ECM, O/D main switch and ECM, O/D main switch and body ground (See page IN-20).

O/D Cancel Signal Circuit

CIRCUIT DESCRIPTION

While driving uphill with cruise control activated, in order to minimize gear shifting and provide smooth cruising overdrive may be prohibited temporarily under some condition.

The cruise control ECU sends O/D cut signals to the ECM as necessary and the ECM cancels overdrive shifting until these signals are discontinued.

WIRING DIAGRAM

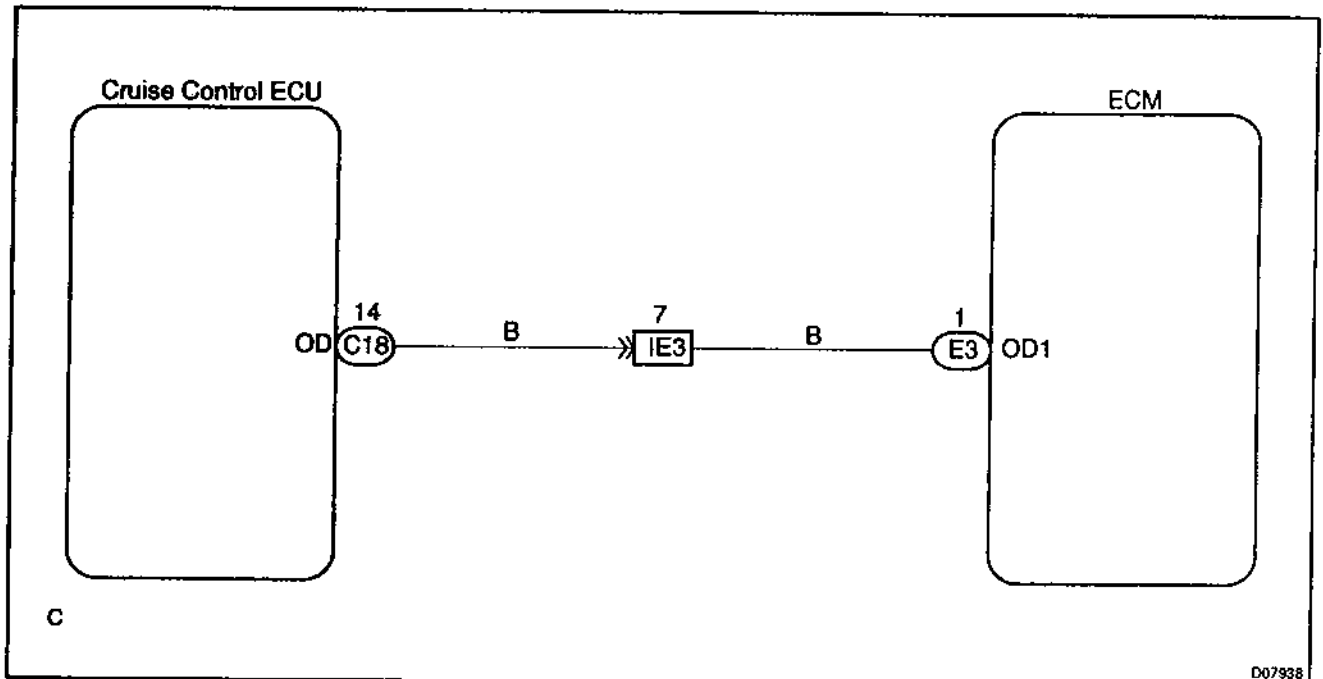

INSPECTION PROCEDURE

- 1 Check voltage between terminal OD1 of ECM and body ground.

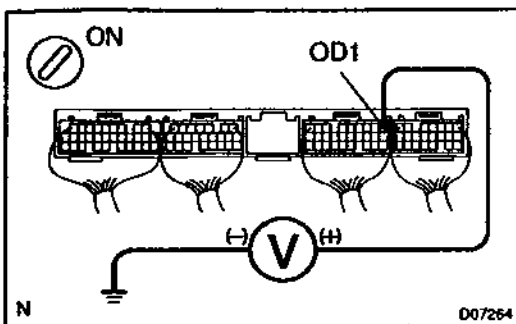
**PREPARATION:**

Turn the ignition switch ON.

CHECK:

Measure voltage between terminal OD1 of ECM and body ground.

OK:

Voltage: 10 - 14 V

OK

Proceed to next circuit inspection shown on matrix chart (See page DI-172).

NG

- 2 Check voltage between terminal OD of cruise control ECU harness side connector and body ground.

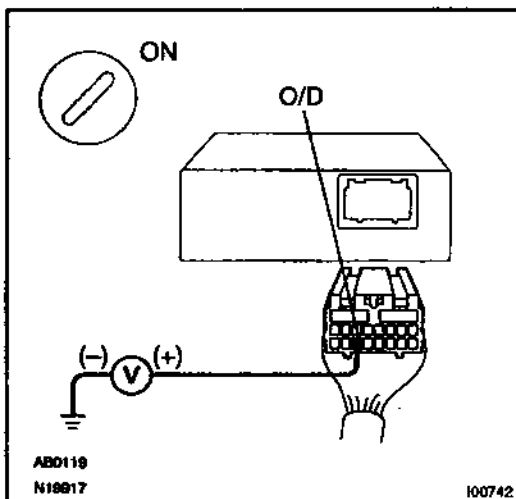
**PREPARATION:**

(a) Disconnect the cruise control ECU connector.

(b) Turn the ignition switch ON.

CHECK:

Measure voltage between terminal OD of cruise control ECU harness side connector and body ground.

OK:

Voltage: 10 - 14 V

OK

Check and replace the cruise control ECU.

NG

3	Check harness and connector between cruise control ECU and ECM (See page IN-30).
----------	---------------------------------------------------------------------------------------------

NG

Repair or replace the harness or connector.

OK

**Check and replace the ECM
(See page IN-30).**

Transmission Shift Switch Circuit

CIRCUIT DESCRIPTION

When shifting the shift lever in M position, using the transmission shift switch, it is possible to shift in 2 - 4 positions.

Pressing "Up switch" once shifts up 1 position, "Down switch" once shifts down 1 position respectively.

WIRING DIAGRAM

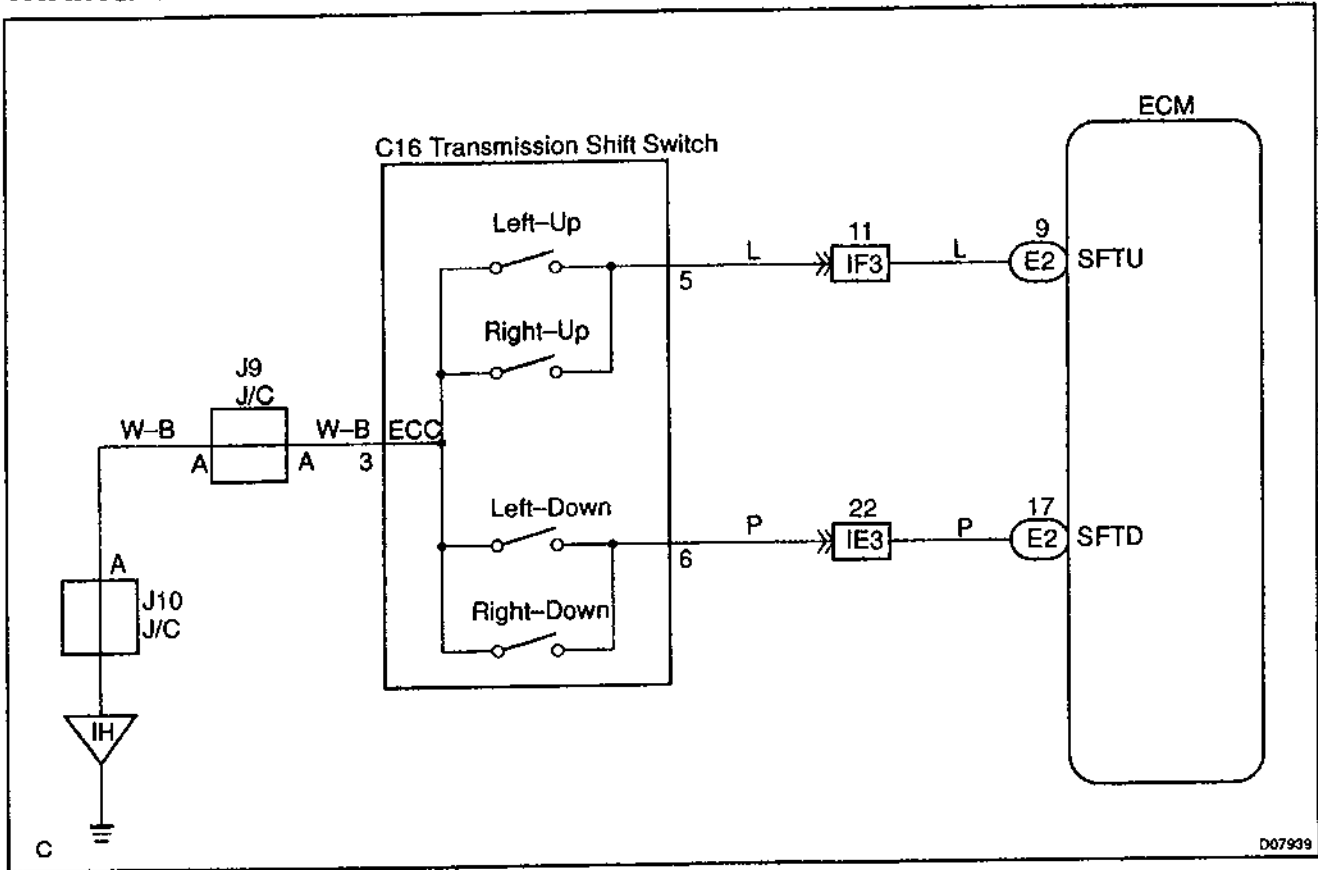

INSPECTION PROCEDURE

1 Check the shift lock control unit assembly (See page AX-16).

NG

Replace the shift lock control unit assembly.

OK

2 Check operation of transmission shift switch.

PREPARATION:

- (a) Turn the ignition switch ON.
- (b) Shift the shift lever into the M position.

CHECK:

Check the odo trip display panel when the transmission shift switch is pressed.

OK:

Switch condition	Odo trip display panel
"Up" switch press	Shift up
"Down" switch press	Shift down

NG

Go to step 5 .

OK

3 Check voltage between each of terminals SFTU and SFTD of ECM and body ground.

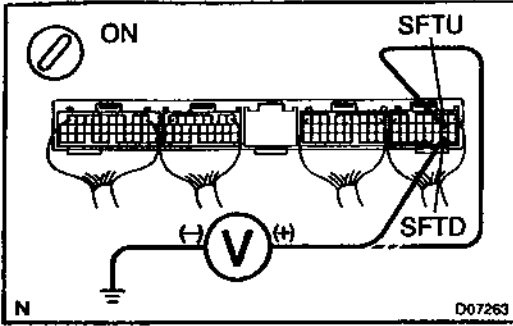

PREPARATION:

- (a) Turn ignition switch ON.
- (b) Remove the ECM with connectors still connected.

CHECK:

Check voltage between each terminals of SFTU and SFTD of ECM and body ground.

OK:

Switch condition	Tester connection	Specified condition
"Up" switch held pressing	SFTU - Body ground	10 - 14 V
"Up" switch released		Below 1.5 V
"Down" switch held pressing	SFTD - Body ground	10 - 14 V
"Down" switch released		Below 1.5 V

OK Proceed to next circuit inspection shown in problem symptoms table (See page DI-172).

NG

4 Check harness and connector between battery and ECM, ECM and odo trip display panel (See page IN-30).

NG Repair or replace harness or connector.

OK

Check and replace ECM (See page IN-30).

5 Check transmission shift switch.

PREPARATION:

- (a) Remove the steering wheel pad.
- (b) Disconnect the transmission shift switch connector.

CHECK:

Check continuity between each terminal of transmission shift switch connector.

OK:

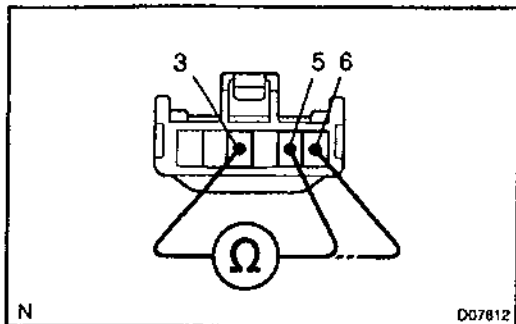

Switch condition	Tester connection	Specified value
"Up" switch pressed	3 - 5	No continuity
"Up" switch released		Continuity
"Down" switch pressed	3 - 6	No continuity
"Down" switch released		Continuity

NG Replace the steering wheel.

OK

Check and replace combination meter (See combination meter troubleshooting section on page BE-2).

E-Shift Main Switch Circuit

CIRCUIT DESCRIPTION

When the shift lever is shifted from the D to M position (the E-shift main switch is pressed), "M" on the combination meter lights up. When the "M" on the combination meter turns off. When the "M" on the combination meter is flashing, the system may be defective or the ATF temperature may be excessively high or low.

WIRING DIAGRAM

See page DI-594.

INSPECTION PROCEDURE**"M" position indicator light flashes.**

When the ATF temperature is too high or low, the M position indicator light flashes. If this happens, shift the shift lever to the D position and shift it back to the M position after the ATF temperature increase or decrease. If the M position indicator light is still flashing, check if DTC P0710 is displayed or not and inspect the transmission shift main switch circuit.

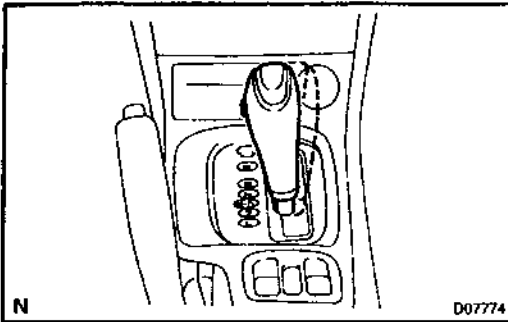
"M" position indicator light does not light up.**1 Check operation of M indicator light.****CHECK:**

Check if the M indicator light normally when the shift lever is set to D position and M position.

OK:

Shift Lever Position	Specified Condition
M	"M" indicator light comes on
Except M	"M" indicator light goes off

NG

Check and repair the M indicator light (See page BE-2).

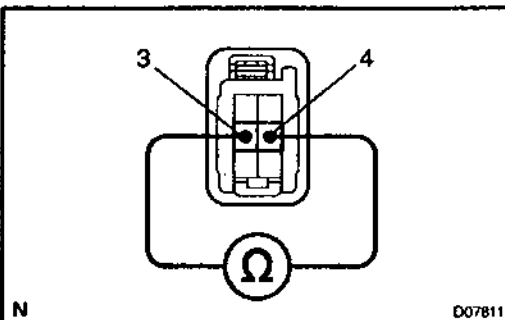
OK**2 Check E-shift main switch.****CHECK:**

Check continuity between each terminal of the E-shift shift main switch.

OK:

Shift Lever Position	Tester connection	Specified value
M	3 - 4	Continuity
Except M	3 - 4	No continuity

If the continuity is not as specified, replace the switch.

AUTOMATIC TRANSAXLE (U341E)

HOW TO PROCEED WITH TROUBLESHOOTING

04mm-01

Items inside  are titles of pages in this manual, with the page number indicated in the bottom portion. See the indicated pages for detailed explanations.

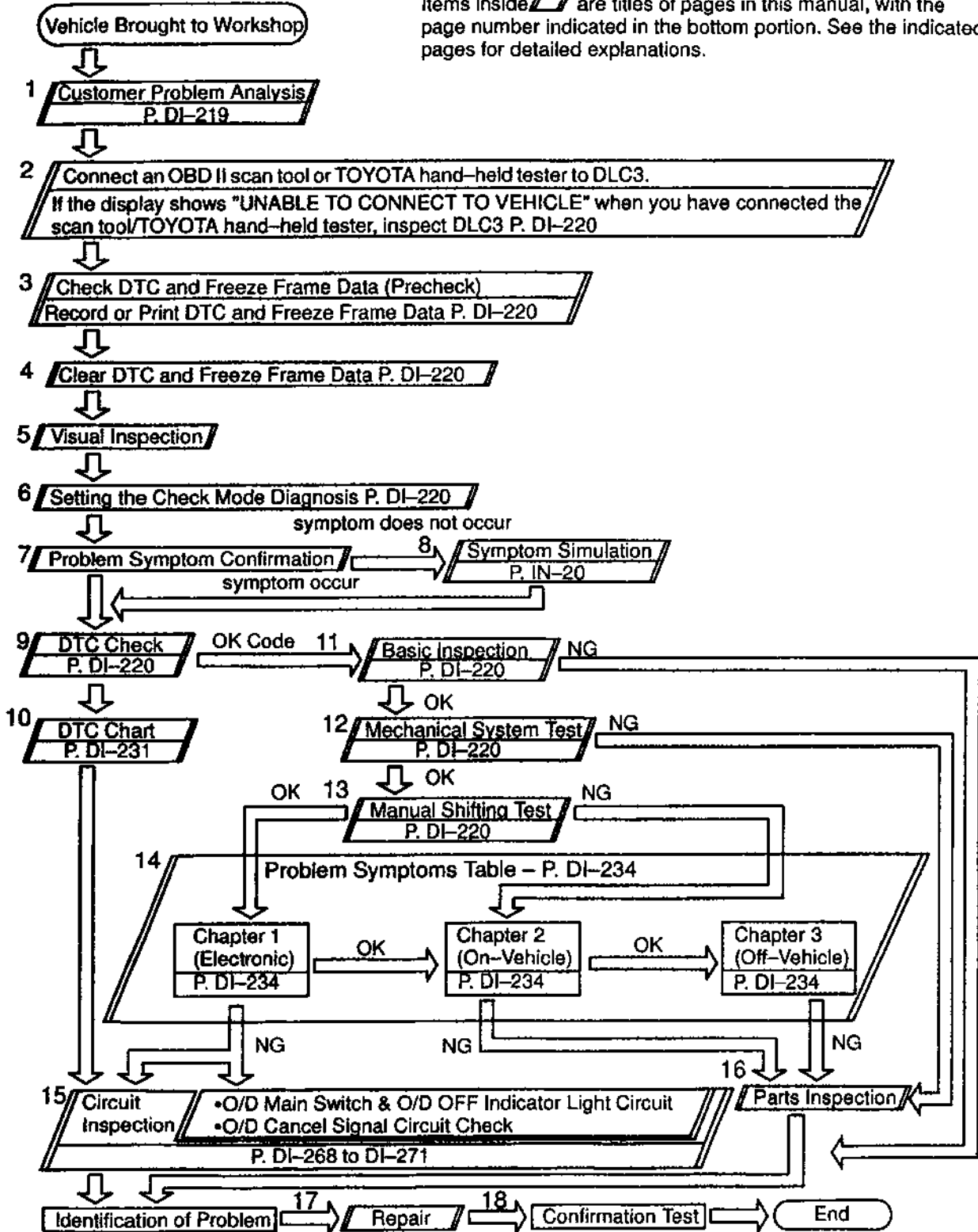

CUSTOMER PROBLEM ANALYSIS CHECK

**Automatic Transaxle
System Check Sheet**

Inspector's Name _____

Customer's Name	Registration No.	
	Registration Year	/ /
	Frame No.	
Date Vehicle Brought In	/ /	Odometer Reading km mile

Date Problem Occurred	/ /
How Often Does Problem Occur?	<input type="checkbox"/> Continuous <input type="checkbox"/> Intermittent (_____ times a day)

Symptoms	<input type="checkbox"/> Vehicle does not move (<input type="checkbox"/> Any position <input type="checkbox"/> Particular position)
	<input type="checkbox"/> No up-shift (<input type="checkbox"/> 1st → 2nd <input type="checkbox"/> 2nd → 3rd <input type="checkbox"/> 3rd → O/D)
	<input type="checkbox"/> No down-shift (<input type="checkbox"/> O/D → 3rd <input type="checkbox"/> 3rd → 2nd <input type="checkbox"/> 2nd → 1st)
	<input type="checkbox"/> Lock-up malfunction
	<input type="checkbox"/> Shift point too high or too low
	<input type="checkbox"/> Harsh engagement (<input type="checkbox"/> N → D <input type="checkbox"/> Lock-up <input type="checkbox"/> Any drive position)
	<input type="checkbox"/> Slip or shudder
	<input type="checkbox"/> No kick-down
<input type="checkbox"/> Others (_____)	

Check Item	Malfunction Indicator Lamp	<input type="checkbox"/> Normal <input type="checkbox"/> Remains ON
------------	----------------------------	---------------------------------------------------------------------

DTC Check	1st Time	<input type="checkbox"/> Normal code <input type="checkbox"/> Malfunction code (DTC _____)
	2nd Time	<input type="checkbox"/> Normal code <input type="checkbox"/> Malfunction code (DTC _____)

PRE-CHECK

1. DIAGNOSIS SYSTEM

(a) Description

- When troubleshooting OBD II vehicles, the only difference from the usual troubleshooting procedure is that you connect to the vehicle an OBD II scan tool complying with SAE J1987 or TOYOTA hand-held tester, and read off various data output from the vehicle's ECM.
- OBD II regulations require that the vehicle's on-board computer lights up the Malfunction Indicator Lamp (MIL) on the instrument panel when the computer detects a malfunction in the computer itself or in drive system components which affect vehicle emissions. In addition to the MIL lighting up when a malfunction is detected, the applicable DTCs prescribed by SAE J2012 are recorded in the ECM memory (See page DI-14).

If the malfunction only occurs in 3 trips, the MIL goes off but the DTCs remain recorded in the ECM memory.

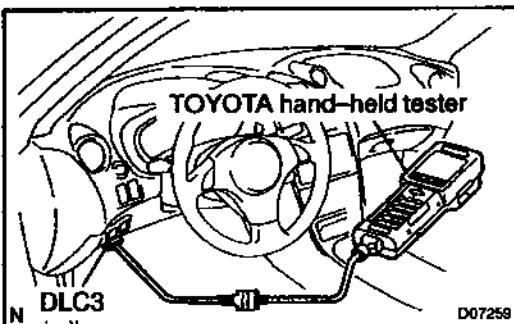
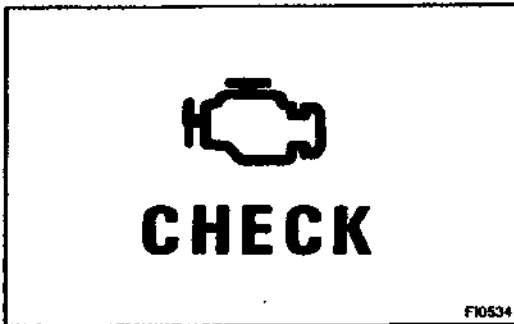

- To check the DTCs, connect an OBD II scan tool or TOYOTA hand-held tester to DLC3 on the vehicle. The OBD II scan tool or TOYOTA hand-held tester also enables you to erase the DTCs and check freeze frame data and various forms of engine data (For instruction book).
- DTCs include SAE controlled codes and Manufacturer controlled codes. SAE controlled codes must be set as prescribed by the SAE, while Manufacturer controlled codes can be set freely by the manufacturer within the prescribed limits (See DTC chart on page DI-231).

- The diagnosis system operates in normal mode during normal vehicle use, and also has a check mode for technicians to simulate malfunction symptoms and perform troubleshooting. Most DTCs use 2-trip detection logic (*) to prevent erroneous detection. By switching the ECM to check mode when troubleshooting, the technician can cause the MIL to light up and for a malfunction that is only detected once or momentarily.
(TOYOTA hand-held tester) (See page DI-220)

- *2-trip detection logic:

When a logic malfunction is first detected, the malfunction is temporarily stored in the ECM memory.

If the same malfunction is detected again during the 2nd test drive, this 2nd detection causes the MIL to light up .

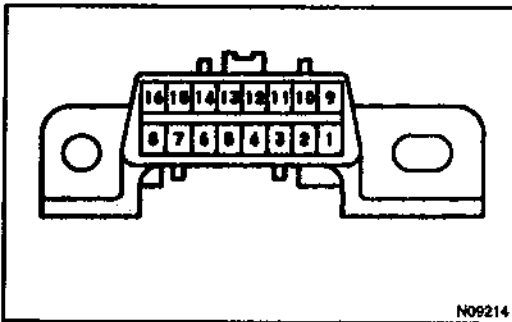

- (b) Inspect the DLC3.

The vehicle's ECM uses ISO 9141-2 for communication. The terminal arrangement of DLC3 complies with SAE J1962 and matches the ISO 9141-2 format.

Tester connection	Condition	Specified condition
7 (Bus ⊕ Line) - 5 (Signal ground)	During communication	Pulse generation
4 (Chassis Ground) - Body	Always	1 Ω or less
5 (Signal Ground) - Body	Always	1 Ω or less
16 (B*) - Body	Always	9 - 14 V

HINT:

If your display shows "UNABLE TO CONNECT TO VEHICLE" when you have connected the cable of OBD II scan tool or TOYOTA hand-held tester to DLC3, turned the ignition switch ON and operated the scan tool, there is a problem on the vehicle side or tool side.

- If communication is normal when the tool is connected to another vehicle, inspect DLC3 on the original vehicle.
- If communication is still not possible when the tool is connected to another vehicle, the problem is probably in the tool itself, so consult the Service Department listed in the tool's instruction manual.

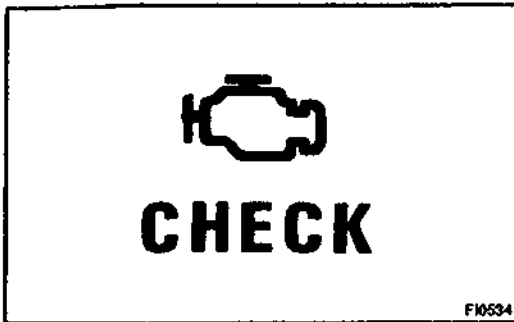

2. INSPECT DIAGNOSIS (NORMAL MODE)

- (a) Check the MIL.
- (1) The MIL comes on when the ignition switch is turned ON and the engine is not running.

HINT:

If the MIL does not light up, troubleshoot the combination meter (See page BE-2).

- (2) When the engine is started, the MIL should go off. If the lamp remains on, the diagnosis system has detected a malfunction or abnormality in the system.

- (b) Check the DTC.

NOTICE:

TOYOTA hand-held tester only: When the diagnostic system is switched from normal mode to check mode, it erases all DTCs and freeze frame data recorded in normal mode. So before switching modes, always check the DTCs and freeze frame data, and note them down.

- (1) Prepare an OBD II scan tool (complying with SAE J1978) or TOYOTA hand-held tester.
- (2) Connect the OBD II scan tool or TOYOTA hand-held tester to DLC3 at the lower of the instrument panel.
- (3) Turn the ignition switch ON and turn the OBD II scan tool or TOYOTA hand-held tester switch ON.
- (4) Use the OBD II scan tool or TOYOTA hand-held tester to check the DTCs and freeze frame data and note them down (For operating instructions, see the OBD II scan tool's instruction book).
- (5) See page DI-231 to confirm the details of the DTCs.

NOTICE:

When simulating symptoms with an OBD II scan tool (excluding TOYOTA hand-held tester) to check the DTCs, use normal mode. For codes on the DTCs chart subject to "2-trip detection logic", turn the ignition switch OFF after the symptoms have been simulated the 1st time. Then repeat the simulation process again. When the program has DTCs are recorded in the ECM.

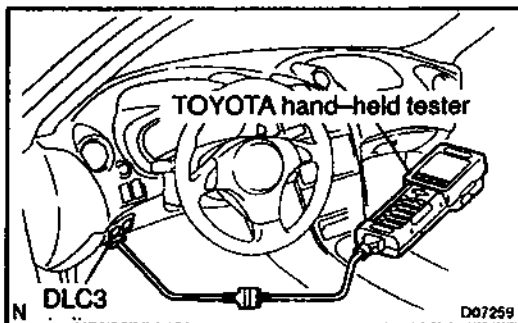

3. INSPECT DIAGNOSIS (CHECK MODE)**HINT:**

TOYOTA hand-held tester only: Compared to the normal mode, the check mode has high sensing ability to detect malfunctions. Furthermore, the same diagnostic items which are detected in Normal mode can also be detected in Check mode.

(a) Check the DTC.

- (1) Check the initial conditions.
 - Battery positive voltage 11 V or more.
 - Throttle valve fully closed.
 - Transaxle in P position.
 - Air conditioning switched off.
- (2) Turn the ignition switch OFF.
- (3) Prepare a TOYOTA hand-held tester.

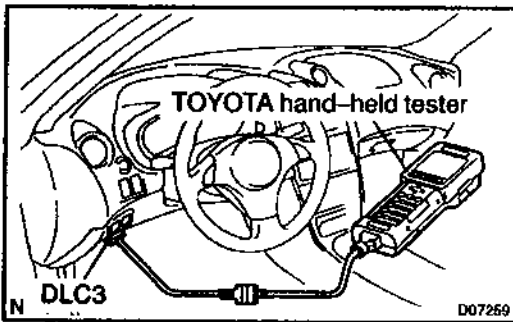

- (4) Connect the TOYOTA hand-held tester to DLC3 at the lower of the instrument panel.
- (5) Turn the ignition switch ON and switch the TOYOTA hand-held tester ON.

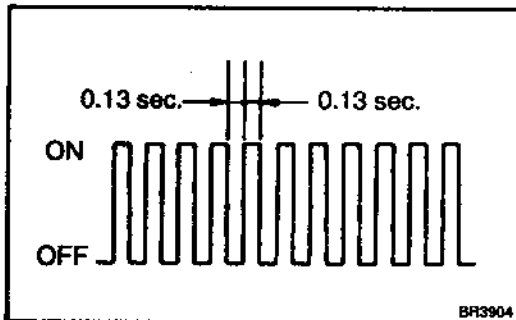

- (6) Switch the TOYOTA hand-held tester from Normal mode to Check mode (Check that the MIL flashes).
- (7) Start the engine (MIL goes out after the engine starts).
- (8) Simulate the conditions of the malfunction described by the customer.

NOTICE:

Leave the ignition switch ON until you have checked the DTCs, etc.

- (9) After simulating the malfunction conditions, use the TOYOTA hand-held tester diagnosis selector to check the DTCs and freeze frame data, etc.

HINT:

Take care not to turn the ignition switch OFF, as turning it off the diagnosis system from Check mode to Normal mode, so all DTCs, etc. are erased.

- (10) After checking the DTC, inspect the applicable circuit.

(b) Clear the DTC.

The following operation will erase the DTC and freeze frame data. Operating an OBD II scan tool (complying with SAE J1978) or TOYOTA hand-held tester to erase the codes.

(See the OBD II scan tool's instruction book for operating instructions.)

NOTICE:

If the TOYOTA hand-held tester switches the ECM from Normal mode to Check mode or vice-versa, or if the ignition switch is turned from ON to ACC or OFF during check mode, the DTCs and freeze frame data will be erased.

4. PROBLEM SYMPTOM CONFIRMATION

Taking into consideration the results of the customer problem analysis, try to reproduce the symptoms of the trouble. If the problem is that the transaxle does not up-shift, down-shift, or the shift point is too high or too low, conduct the following road test to confirm the automatic shift schedule and simulate the problem symptoms.

5. ROAD TEST**NOTICE:**

Perform the test at normal operating ATF temperature 50 – 80 °C (122 – 176 °F).

(a) D position test

Shift into the D position and fully depress the accelerator pedal and check the following points.

(1) Check up-shift operation.

Check to see that 1 → 2, 2 → 3 and 3 → O/D up-shift takes place, and that the shift points conform to the automatic shift schedule (See page SS-43).

HINT:

- O/D Gear Up-shift Prohibition Control (1. Coolant temp. is 60 °C (140 °F) or less. 2. If there is a 10 km/h (6 mph) difference between the set cruise control speed and vehicle speed.)
- O/D Gear Lock-up Prohibition Control (1. Brake pedal is depressed. 2. Coolant temp. is 60 °C (140 °F) or less.)

(2) Check for shift shock and slip.

Check for shock and slip at the 1 → 2, 2 → 3 and 3 → O/D up-shifts.

(3) Check for abnormal noises and vibration.

Drive in the D position lock-up or O/D gear and check for abnormal noises and vibration.

HINT:

The check for the cause of abnormal noises and vibration must be done very thoroughly as it could also be due to loss of balance in the differential torque converter clutch, etc.

(4) Check kick-down operation.

While running in the D position, 2nd, 3rd and O/D gears, check to see that the possible kick-down vehicle speed limits for 2 → 1, 3 → 2 and O/D → 3 kick-downs conform to those indicated on the automatic shift schedule (See page SS-43).

(5) Check abnormal shock and slip at kick-down.

(6) Check the lock-up mechanism.

- Drive in D position, O/D gear, at a steady speed (lock-up ON) of about 60 km/h (37 mph).
- Lightly depress the accelerator pedal and check that the engine speed does not change abruptly.

If there is a big jump in engine speed, there is no lock-up.

(b) 2 position test

Shift into the 2 position and fully depress the accelerator pedal and check the following points.

(1) Check up-shift operation.

Check to see that the 1 → 2 up-shift takes place and that the shift point conforms to the automatic shift schedule (See page SS-43).

HINT:

There is no O/D up-shift and lock-up in the 2 position.

(2) Check engine braking.

While running in the 2 position and 2nd gear, release the accelerator pedal and check the engine braking effect.

(3) Check for abnormal noises during acceleration and deceleration, and for shock at up-shift and down-shift.

(c) L position test

Shift into the L position and fully depress the accelerator pedal and check the following points.

(1) Check no up-shift.

While running in the L position, check that there is no up-shift to 2nd gear.

(2) Check engine braking.

While running in the L position, release the accelerator pedal and check the engine braking effect.

(3) Check for abnormal noises during acceleration and deceleration.

(d) R position test

Shift into the R position and fully depress the accelerator pedal and check for slipping.

CAUTION:

Before conducting this test ensure that the test area is free from people and obstruction.

(e) P position test

Stop the vehicle on a grade (more than 5°) and after shifting into the P position, release the parking brake. Then, check to see that the parking lock pawl holds the vehicle in place.

6. BASIC INSPECTION

(a) Check the fluid level.

HINT:

- Drive the vehicle so that the engine and transaxle are at normal operating temperature.

Fluid temp.: 70 – 80 °C (158 – 176 °F)

- Only use the COOL range on the dipstick as a rough reference when the fluid is replaced or the engine does not run.

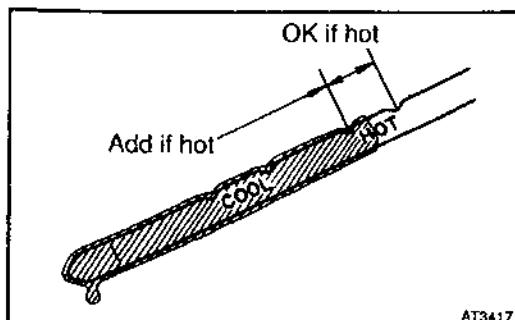

- (1) Park the vehicle on a level surface and set the parking brake.
- (2) With the engine idling and the brake pedal depressed, shift the shift lever into all positions from P to L position and return to P position.
- (3) Pull out the dipstick and wipe it clean.
- (4) Push it back fully into the pipe.
- (5) Pull it out and check that the fluid level is in the HOT range.

If the level is at the low side, add new fluid.

Capacity: 2.9 liters (3.1 US qts, 2.6 Imp. qts)

NOTICE:

Do not overfill.

(b) Check the fluid condition.

If the fluid smells burnt or is black, replace it.

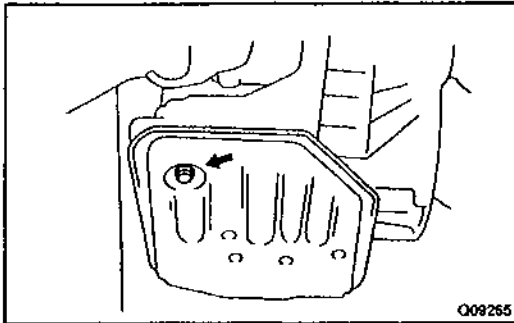

(c) Replace the ATF.

(1) Remove the drain plug and drain the fluid.

(2) Reinstall the drain plug securely.

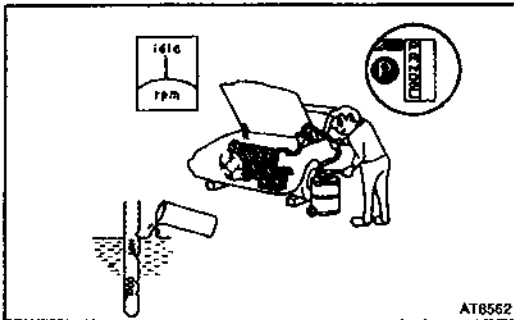

(3) With the engine OFF add new fluid through the oil filler pipe.

Fluid type: ATF Type T-IV

Capacity: 2.9 liters (3.1 US qts, 2.6 Imp. qts)

(4) Start the engine and shift the shift lever into all positions from P to L position and then shift into P position.

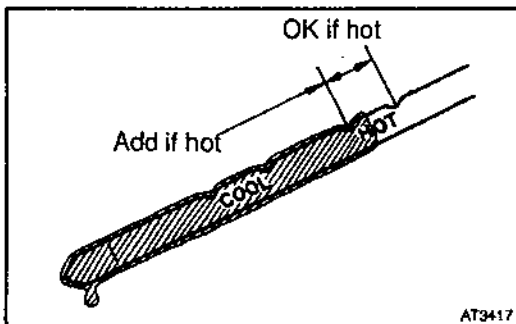

(5) With the engine idling, check the fluid level. Add fluid up to the COOL level on the dipstick.

(6) Check the fluid level at the normal operating temperature, 70 – 80 °C (158 – 176 °F), and add as necessary.

NOTICE:

Do not overfill.

(d) Check the fluid leaks.

Check for leaks in the transaxle.

If there are leaks, it is necessary to repair or replace O-rings, gaskets, oil seals, plugs or other parts.

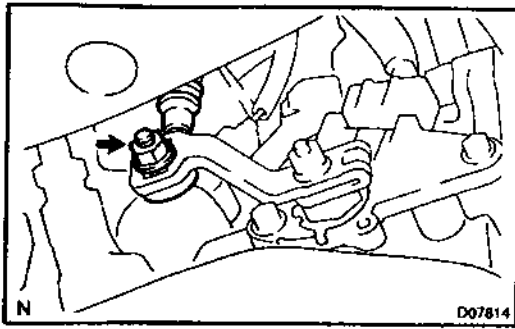

- (e) Inspect and adjust the shift lever position. When shifting the shift lever from the N position to other positions, check that the lever can be shifted smoothly and accurately to each position and that the position indicator is not aligned with the correct position.

If the indicator is not aligned with the correct position, carry out the following adjustment procedures.

- (1) Loosen the nut on the shift lever.
- (2) Push the control shaft fully downward.
- (3) Return the control shaft lever 2 notches to N position.
- (4) Set the shift lever to N position.
- (5) While holding the shift lever lightly toward the R position side, tighten the shift lever nut.

Torque: 13 N·m (130 kgf·cm, 9 ft·lbf)

- (6) Start the engine and make sure that the vehicle moves forward when shifting the lever from the N to D position and reverses when shifting it to the R position.

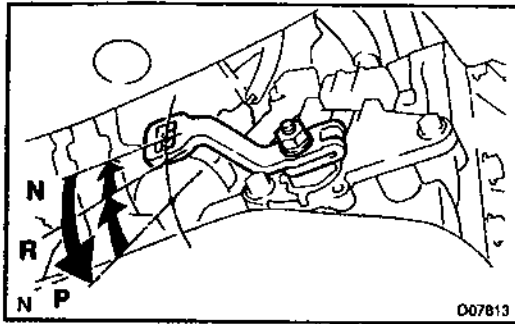

- (f) Inspect and adjust the park/neutral position. Check that the engine can be started with the shift lever only in the N or P position, but not in other positions.

If it is not as stated above, carry out the following adjustment procedures.

- (1) Loosen the park/neutral position switch bolt and set the shift lever to the N position.
- (2) Align the groove and neutral basic line.
- (3) Hold in position and tighten the bolt.

Torque: 5.4 N·m (55 kgf·cm, 48 in·lbf)

For continuity inspection of the park/neutral position switch, see page DI-261.

- (g) Check the idle speed.
Idle speed: 750 ± 50 rpm
(In N position and air conditioner OFF)

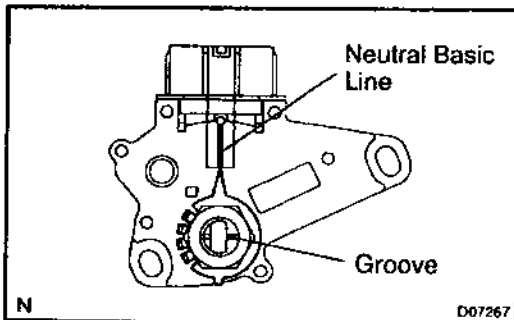

7. MECHANICAL SYSTEM TESTS

- (a) Measure the stall speed.

The object of this test is to check the overall performance of the transaxle and engine by measuring the stall speeds in the D and R positions.

NOTICE:

- Do the test at normal operating fluid temperature 50 – 80 °C (122 – 176 °F).
 - Do not continuously run this test longer than 10 seconds.
 - To ensure safety, conduct this test in a wide, clear level area which provides good traction.
 - The stall test should always be carried out in pairs. One technician should observe the conditions of wheels or wheel stoppers outside the vehicle while the other is doing the test.
- (1) Chock the 4 wheels.
 - (2) Connect an OBD II scan tool or TOYOTA hand-held tester to DLC3.
 - (3) Fully apply the parking brake.
 - (4) Keep your left foot pressed firmly on the brake pedal.
 - (5) Start the engine.

- (6) Shift into the D position. Press all the way down on the accelerator pedal with your right foot. Quickly read the stall speed at this time.

Stall speed: 2,350 – 2,800 rpm

- (7) Do the same test in R position.

Stall speed: 2,350 – 2,800 rpm

Evaluation:

Problem	Possible cause
(a) Stall speed low in D and R positions	<ul style="list-style-type: none"> • Engine output may be insufficient • Stator one-way clutch is operating properly <p>HINT: If more than 600 rpm below the specified value, the torque converter clutch could be faulty.</p>
(b) Stall speed high in D position	<ul style="list-style-type: none"> • Line pressure too low • Forward clutch slipping • No.2 one-way clutch not operating properly
(c) Stall speed high in R position	<ul style="list-style-type: none"> • Line pressure too low • Reverse clutch slipping • 1st & reverse brake slipping
(d) Stall speed high in D and R positions	<ul style="list-style-type: none"> • Line pressure too low • Improper fluid level

- (b) Measure the time lag.

When the shift lever is shifted while the engine is idling, there will be a certain time lapse or lag before the shock can be felt. This is used for checking the condition of the No. 2 one-way clutch, reverse clutch, forward clutch, and 1st & reverse brake.

NOTICE:

- Do the test at normal operating fluid temperature 50 – 80 °C (122 – 176 °F).
- Be sure to allow 1 minute interval between tests.
- Take 3 measurements and take the average value.

- (1) Connect an OBD II scan tool or TOYOTA hand-held tester to DLC3.
- (2) Fully apply the parking brake.
- (3) Start the engine and check idle speed.

Idle speed: 750 ± 50 rpm (In N position and air conditioner OFF)

- (4) Shift the shift lever from N to D position. Using a stop watch, measure the time from when the lever is shifted until the shock is felt.

Time lag: N → D Less than 1.2 seconds

- (5) In the same manner, measure the time lag for N → R.

Time lag: N → R Less than 1.5 seconds

Evaluation (If N → D time or N → R time lag is longer than specified):

Problem	Possible cause
N → D time lag is longer	<ul style="list-style-type: none"> • Line pressure too low • Forward clutch worn • No. 2 one-way clutch not operating
N → R time lag is longer	<ul style="list-style-type: none"> • Line pressure too low • Reverse clutch worn • 1st & reverse brake worn

8. HYDRAULIC TEST

Measure the line pressure.

NOTICE:

- **Do the test at normal operation fluid temperature 50 – 80 °C (122 – 176 °F)**
 - **The line pressure test should always be carried out in pairs. One technician should observe the conditions of wheels or wheel stoppers outside the vehicle while the other is doing the test.**
 - **Be careful to prevent SST's hose from interfering with the exhaust pipe.**
 - (1) Warm up the ATF.
 - (2) Remove the test plug on the transaxle case front left side and connect SST.
(See page AX-30 for the location to connect SST)
- SST 09992-00095 (09992-00231, 09992-00271)
- (3) Fully apply the parking brake and chock the 4 wheels.
 - (4) Connect an OBD II scan tool or TOYOTA hand-held tester to DLC3.
 - (5) Start the engine and check idling speed.
 - (6) Keep your left foot pressed firmly on the brake pedal and shift into D position.
 - (7) Measure the line pressure when the engine is idling.
 - (8) Depress the accelerator pedal all the way down. Quickly read the highest line pressure when engine speed reaches stall speed.
 - (9) In the same manner, do the test in R position.

Specified line pressure:

Condition	D position kPa (kgf/cm ² , psi)	R position kPa (kgf/cm ² , psi)
Idling	372 – 412 (3.8 – 4.2, 54 – 60)	588 – 686 (6.0 – 7.0, 85 – 100)
Stall	1,157 – 1,265 (11.8 – 12.9, 168 – 183)	1,589 – 1,765 (16.2 – 18.0, 230 – 256)

If the measured pressure is not up to specified value, recheck the throttle cable adjustment and retest.

Evaluation:

Problem	Possible cause
If the measured values at all position are higher	<ul style="list-style-type: none"> • Shift solenoid valve SLT • Regulator valve defective
If the measured values at all position are lower	<ul style="list-style-type: none"> • Shift solenoid valve SLT • Regulator valve defective • Oil pump defective
If pressure is low in the D position only	<ul style="list-style-type: none"> • D position circuit fluid leakage • Forward clutch defective
If pressure is low in the R position only	<ul style="list-style-type: none"> • R position circuit fluid leakage • Reverse clutch defective • 1st & reverse brake defective

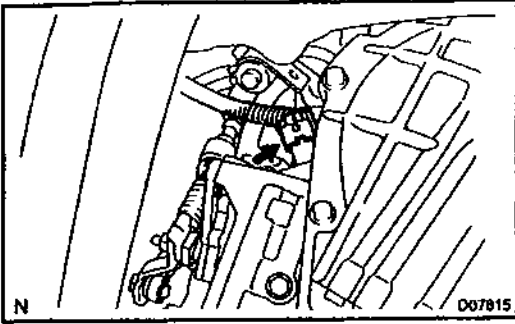

9. MANUAL SHIFTING TEST

HINT:

With this test, it can be determined whether the trouble is within the electrical circuit or is a mechanical problem in the transaxle.

- (a) Disconnect the solenoid wire.
- (b) Inspect the manual driving operation.

Check that the shift and gear positions correspond with the table below.

While driving, shift through the L, 2 and D positions. Check that the gear change corresponds to the shift position.

Shift Position	Gear Position
D	3rd
2	3rd
L	3rd
R	Reverse
P	Pawl Lock

HINT:

If the L, 2 and D position gear positions are difficult to positions are difficult to distinguish, do the following read test.

If any abnormality is found in the above test, the problem is in the transaxle itself.

- (c) Connect the solenoid wire.
- (d) Cancel out DTC (See page DI-220).

DIAGNOSTIC TROUBLE CODE CHART

If a DTC is displayed during the DTC check, check the circuit listed for that code in the table below and proceed to the page given.

* : -...MIL does not light / ●...MIL light up

DTC No. (See Page)	Detection Item	Trouble Area	MIL *	Memory
P0500 (DI-238)	Vehicle Speed Sensor Malfunction	<ul style="list-style-type: none"> • Open or short in vehicle speed sensor circuit • Vehicle speed sensor • Combination meter • ECM • Automatic transaxle assembly 	●	○
P0710 (DI-242)	Transmission Fluid Temperature Sensor Malfunction (ATF Temperature Sensor)	<ul style="list-style-type: none"> • Open or short in ATF temperature sensor circuit • ATF temperature sensor • ECM 	●	○
P0750 (DI-244)	Shift Solenoid A Malfunction (Shift Solenoid Valve No. 1)	<ul style="list-style-type: none"> • Shift solenoid valve No. 1 is stuck open or closed • Valve body is blocked up or stuck 	●	○
P0753 (DI-246)	Shift Solenoid A Electrical Mal- function (Shift Solenoid Valve No. 1)	<ul style="list-style-type: none"> • Open or short in shift solenoid valve No. 1 circuit • Shift solenoid valve No. 1 • ECM 	●	○
P0755 (DI-244)	Shift Solenoid B Malfunction (Shift Solenoid Valve No. 2)	<ul style="list-style-type: none"> • Shift solenoid valve No. 2 is stuck open or closed • Valve body is blocked up or stuck 	●	○
P0758 (DI-246)	Shift Solenoid B Electrical Mal- function (Shift Solenoid Valve No. 2)	<ul style="list-style-type: none"> • Open or short in shift solenoid valve No. 2 circuit • Shift solenoid valve No. 2 • ECM 	●	○
P0770 (DI-250)	Shift Solenoid E Malfunction (Shift Solenoid Valve SL)	<ul style="list-style-type: none"> • Shift solenoid valve SL is stuck open or closed • Valve body is blocked up or stuck • Lock-up clutch 	●	○
P0773 (DI-252)	Shift Solenoid E Electrical Mal- function (Shift Solenoid Valve SL)	<ul style="list-style-type: none"> • Open or short in shift solenoid valve SL circuit • Shift solenoid valve SL • ECM 	●	○
P1520 (DI-255)	Stop Light Switch Circuit	<ul style="list-style-type: none"> • Open or short in stop light switch circuit • Stop light switch • ECM 	●	○
P1725 (DI-256)	NT Revolution Sensor Circuit Malfunction (Input Turbine Speed Sensor)	<ul style="list-style-type: none"> • Open or short in input turbine speed sensor circuit • Input turbine speed sensor • ECM 	●	○
P1760 (DI-258)	Linear Solenoid for Accumulator Pressure Control Circuit Mal- function (Shift Solenoid Valve SLT)	<ul style="list-style-type: none"> • Open or short in shift solenoid valve SLT circuit • Shift solenoid valve SLT • ECM 	●	○
P1780 (DI-261)	Park/Neutral Position Switch Malfunction	<ul style="list-style-type: none"> • Short in park/neutral position switch circuit • Park/neutral position switch • ECM 	●	○
P1790 (DI-265)	ST Solenoid Valve Circuit Malfunction	<ul style="list-style-type: none"> • Open or short in shift solenoid valve ST circuit • Shift solenoid valve ST • ECM 	●	○

PARTS LOCATION

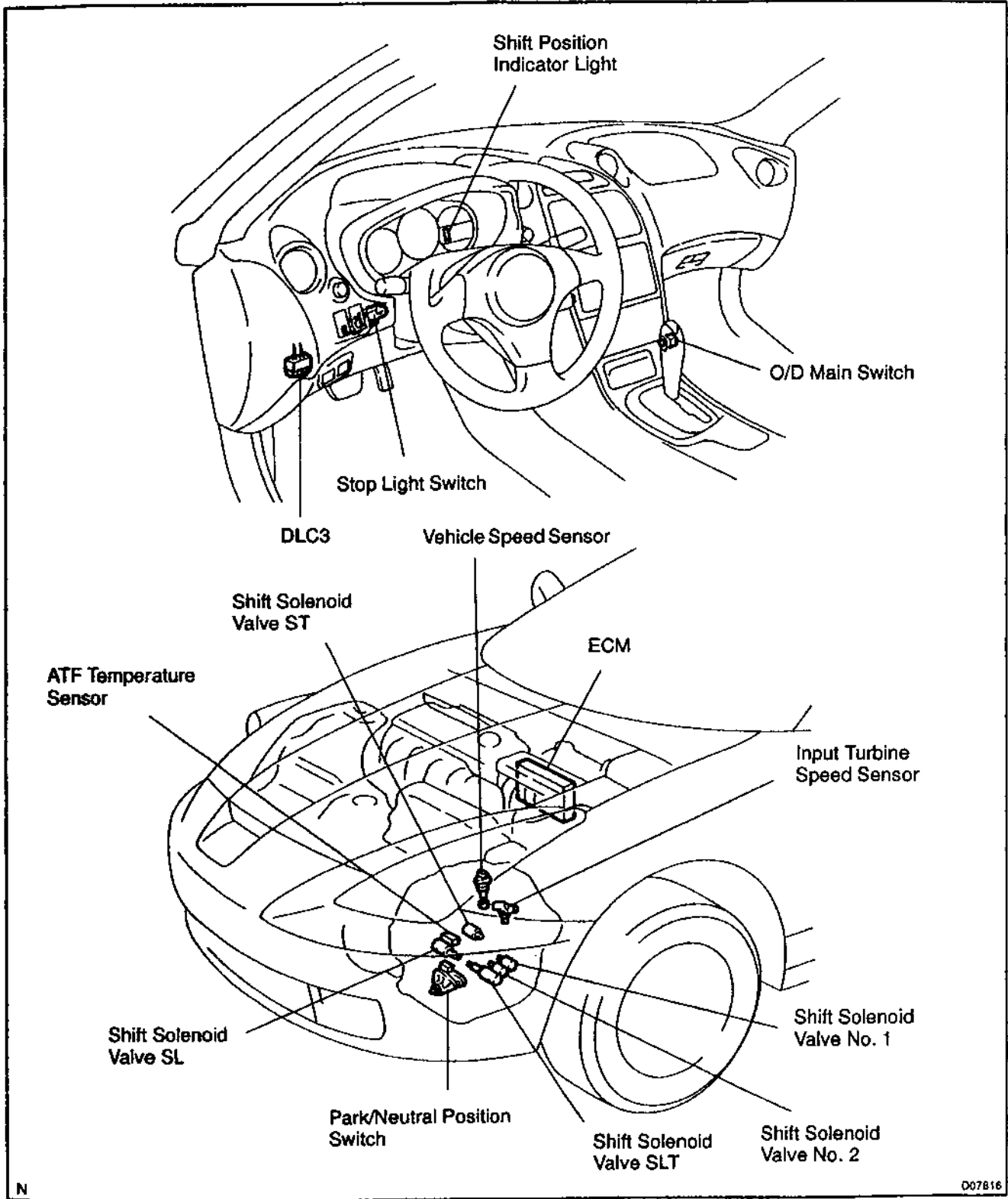

TERMINALS OF ECM

0420-04

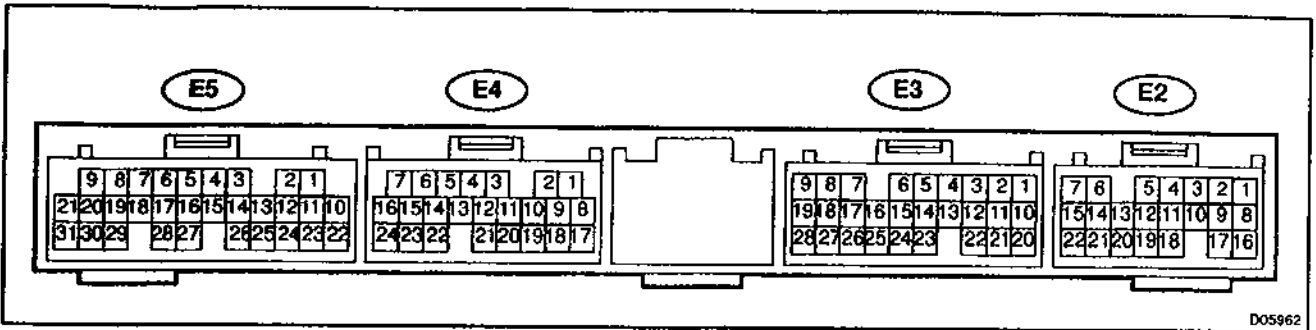

D05962

Symbols (Terminals No.)	Wiring Color	Condition	STD Voltage (V)
S1 (E5-8) ↔ E1 (E4-17)	BR-Y ↔ BR	IG ON	10 - 14
		1st or 2nd gear	10 - 14
		3rd or O/D gear	Below 1
S2 (E5-20) ↔ E1 (E4-17)	Y ↔ BR	IG ON	Below 1
		1st or 2nd gear	10 - 14
		3rd or O/D gear	Below 1
SL (E5-19) ↔ E1 (E4-17)	P-L ↔ BR	IG ON	Below 1
		Vehicle driving under lock-up position	10 - 14
SLT+ (E5-8) ↔ SLT- (E5-5)	Y-R ↔ Y-G	IG ON	10 - 14
OD1 (E3-1) ↔ E1 (E4-17)	B ↔ BR	IG ON	5 - 6
ODLP (E3-10) ↔ E1 (E4-17)	BR-Y ↔ BR	O/D main switch ON	10 - 14
		O/D main switch OFF	Below 1
L (E4-9) ↔ E1 (E4-17)	Y-B ↔ BR	IG ON and Shift lever L position	10 - 14
		IG ON and Shift lever other than L position	Below 1
2 (E4-19) ↔ E1 (E4-17)	L-Y ↔ BR	IG ON and Shift lever 2 position	10 - 14
		IG ON and Shift lever other than 2 position	Below 1
R (E3-2) ↔ E1 (E4-17)	B-O ↔ BR	IG ON and Shift lever R position	10 - 14
		IG ON and Shift lever other than R position	Below 1
D (E3-24) ↔ E1 (E4-17)	L-W ↔ BR	IG ON and Shift lever D position	10 - 14
		IG ON and Shift lever other than D position	Below 1
N (E4-8) ↔ E1 (E4-17)	P-L ↔ BR	IG ON and Shift lever N position	10 - 14
		IG ON and Shift lever other than N position	Below 1
THO (E4-13) ↔ E2 (E4-18)	GR-L ↔ BR	IG ON and ATF temperature 110 °C (230 °F)	Below 1
ST (E5-29) ↔ E1 (E4-17)	BR-W ↔ BR	IG ON	Below 1
		IG ON and R gear	10 - 14
P (E4-20) ↔ E1 (E4-17)	P ↔ BR	IG ON and Shift lever P position	10 - 14
		IG ON and Shift lever other than P position	Below 1
SPD (E3-22) ↔ E1 (E4-17)	W-R ↔ BR	IG ON and rotate driving wheel slowly	Pulse generation
ODMS (E5-5) ↔ E1 (E4-17)	BR-Y ↔ BR	IG ON	Below 1
		IG ON and Press continuously O/D main switch	10 - 14

PROBLEM SYMPTOMS TABLE

If a normal code is displayed during the DTC check but the trouble still occurs, check the circuits for each symptom in the order given in the charts on the following pages and proceed to the page given for trouble-shooting.

The Matrix Chart is divided into 3 chapters.

Chapter 1: Electronic circuit matrix chart

Chapter 2: On-vehicle repair matrix chart

Chapter 3: Off-vehicle repair matrix chart

If the instruction "Proceed to next circuit inspection shown on matrix chart" is given in the flow chart for each circuit, proceed to the circuit with the next highest number in the table to continue the check.

If the trouble still occurs even though there are no abnormalities in any of the other circuits, then check and replace the ECM.

Chapter 1: Electronic Circuit Matrix Chart

Symptom	Suspect Area	See page
No up-shift (A particular gear, from 1st to 3rd gear, is not up-shifted)	ECM	--
No up-shift (3rd → O/D)	1. O/D main switch and O/D OFF indicator light circuit 2. O/D cancel signal circuit 3. ECM	DI-268 DI-271 --
No down-shift (A particular gear, from 1st to 3rd gear, is not down-shifted)	ECM	--
No down-shift (O/D → 3rd)	1. O/D main switch and O/D OFF indicator light circuit 2. ECM	DI-268 --
No lock-up	ECM	--
No lock-up OFF	ECM	--
Shift point too high or too low	ECM	--
Up-shift to O/D from 3rd while O/D main switch is OFF	ECM	--
Up-shift to O/D from 3rd while engine is cold	ECM	--
No kick-down	ECM	--
Engine stalls when starting off or stopping	ECM	--

Chapter 2: On-vehicle Repair**(★: U341E AUTOMATIC TRANSAXLE Repair Manual Pub. No. RM735U)**

Symptom	Suspect Area	See page
Vehicle does not move in any forward position and reverse position	1. Manual valve 2. Primary regulator valve 3. Secondary regulator valve 4. Off-vehicle repair matrix chart	★ ★ ★ -
Vehicle does not move in R position	1. Manual valve 2. Off-vehicle repair matrix chart	★ -
No up-shift (1st → 2nd)	1. 1-2 shift valve 2. Off-vehicle repair matrix chart	★ -
No up-shift (2nd → 3rd)	1. 2-3 shift valve 2. Off-vehicle repair matrix chart	★ -
No up-shift (3rd → O/D)	1. 3-4 shift valve 2. Off-vehicle repair matrix chart	★ -
No down-shift (O/D → 3rd)	3-4 shift valve	★
No down-shift (3rd → 2nd)	2-3 shift valve	★
No down-shift (2nd → 1st)	1-2 shift valve	★
No lock-up or No lock-up off	1. Lock-up relay valve 2. Lock-up control valve 3. Solenoid relay valve 4. Solenoid modulator valve 5. Off-vehicle repair matrix chart	★ ★ ★ ★ -
Harsh engagement (N → D)	1. C ₃ accumulator 2. Accumulator control valve 3. Off-vehicle repair matrix chart	★ ★ -
Harsh engagement (N → R)	1. C ₃ accumulator 2. Accumulator control valve 3. Reverse control valve 4. Off-vehicle repair matrix chart	★ ★ ★ -
Harsh engagement (Lock-up)	1. Lock-up relay valve 2. Accumulator control valve 3. Lock-up control valve 4. Off-vehicle repair matrix chart	★ ★ ★ -
Harsh engagement (1st → 2nd)	1. B ₂ accumulator 2. Accumulator control valve	★ ★
Harsh engagement (2nd → 3rd)	1. C ₂ accumulator 2. Accumulator control valve	★ ★
Harsh engagement (3rd → O/D)	1. B ₁ accumulator 2. Accumulator control valve 3. 3-4 shift timing valve	★ ★ ★
Harsh engagement (O/D → 3)	1. 3-4 shift timing valve 2. 4-3 shift timing valve	★ ★
Harsh engagement (D, 2, L position)	Coat relay valve	★
Slip or shudder (Forward and reverse)	1. Oil strainer 2. Off-vehicle repair matrix chart	AX-9 -
No engine braking (1st: L position)	1. Reverse control valve 2. Off-vehicle repair matrix chart	★ -
No engine braking (2nd: 2 position)	3-4 shift valve	★

No kick-down	1. 1-2 shift valve	★
	2. 2-3 shift valve	★
	3. 3-4 shift valve	★
Poor acceleration	SLT damper	★

Chapter 3: Off-vehicle Repair**(★: U341E AUTOMATIC TRANSAXLE Repair Manual Pub. No. RM735U)**

Symptom	Suspect Area	See page
Vehicle does not move in any forward position and reverse position	1. Planetary gear unit 2. Forward clutch 3. One-way clutch No. 2 4. Reverse Clutch 5. 1st and reverse brake	★ ★ ★ ★ ★
Vehicle does not move in R position	1. Planetary gear unit 2. Reverse Clutch 3. 1st and reverse brake	★ ★ ★
No up-shift (1st → 2nd)	1. 2nd brake 2. One-way clutch No. 1	★ ★
No up-shift (2nd → 3rd)	Direct clutch	★
No up-shift (3rd → O/D)	O/D and 2nd brake	★
No lock-up or No lock-up off	Torque converter clutch	AX-36
Harsh engagement (N → D)	1. Forward clutch 2. One-way clutch No. 2	★ ★
Harsh engagement (N → R)	1. Reverse clutch 2. 1st and reverse brake	★ ★
Harsh engagement (Lock-up)	Torque converter clutch	AX-36
Harsh engagement (1st → 2nd)	1. 2nd brake 2. One-way clutch No. 1	★ ★
Harsh engagement (2nd → 3rd)	Direct clutch	★
Harsh engagement (3rd → O/D)	O/D and 2nd brake	★
Slip or shudder (Forward position)	1. Torque converter clutch 2. Forward clutch 3. Direct clutch 4. O/D and 2nd brake 5. 2nd brake 6. One-way clutch No. 1 7. One-way clutch No. 2	AX-36 ★ ★ ★ ★ ★ ★
Slip or shudder (Reverse position)	1. Reverse clutch 2. 1st and reverse brake	★ ★
Slip or shudder (1st)	One-way clutch No. 2	★
Slip or shudder (2nd)	1. 2nd brake 2. One-way clutch No. 1	★ ★
Slip or shudder (3rd)	Direct clutch	★
Slip or shudder (O/D)	O/D and 2nd brake	★
No engine braking (1st: L position)	1st and reverse brake	★
No engine braking (2nd: 2 position)	O/D and 2nd brake	★
Poor acceleration (All position)	Torque converter clutch	AX-36
Large shift shock or engine stalls when starting off or stopping	Torque converter clutch	AX-36

CIRCUIT INSPECTION

DTC	P0500	Vehicle Speed Sensor Malfunction
------------	--------------	-----------------------------------------

CIRCUIT DESCRIPTION

The vehicle speed sensor outputs a 4-pulse signal for every revolution of the transaxle output shaft. After this signal is converted into a more precise rectangular wave form by the wave form shaping circuit inside the combination meter, it is then transmitted to the ECM.

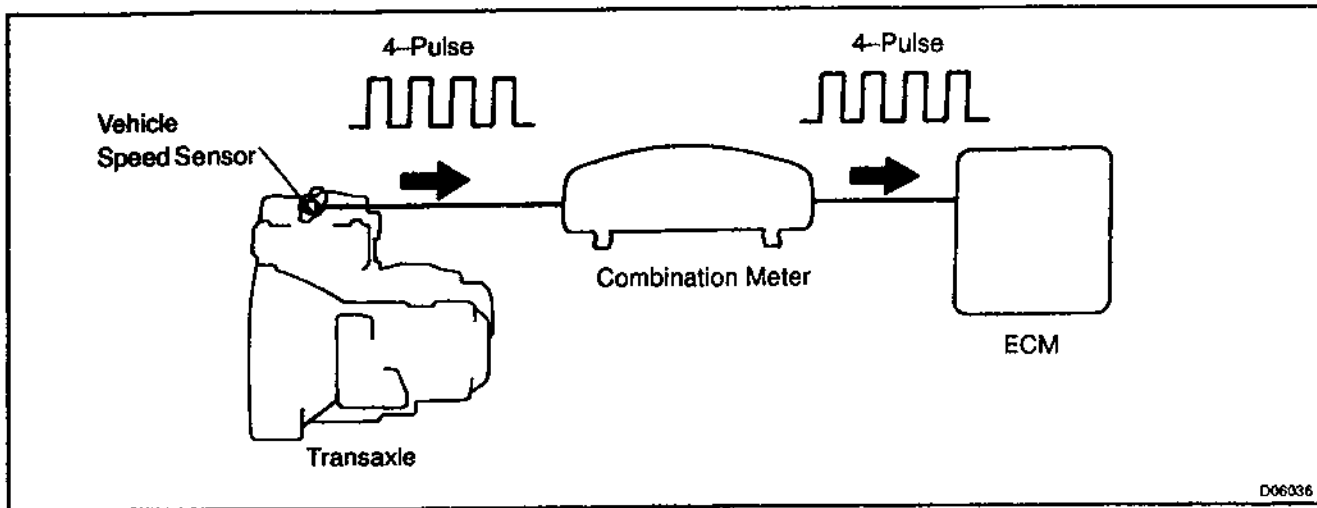

D06036

DTC No.	DTC Detecting Condition	Trouble Area
P0500	When all of the following conditions continues for 1 sec. or more: 1. After the ignition switch is turned on, 0.5 second or more elapses. 2. Counter gear rpm is equal to or greater than vehicle speed. 3. Vehicle speed sensor signal can not be input to the ECM. 4. The condition that engine coolant temp. is 20 °C or more (no error in engine coolant temp. sensor circuit is detected) and the park/neutral position switch is set to P or N continues for 2 for. or more, or the condition that engine coolant temp. is less than 20 °C (an error in engine coolant temp. sensor circuit is detected) and the park/neutral position switch is set to P or N continues for 30 sec. or more.	<ul style="list-style-type: none"> • Combination meter • Open or short in vehicle speed sensor circuit • Vehicle speed sensor • ECM • Automatic transaxle (clutch, brake or gear etc.)
	Clutch or brake slips or gear is broken	

WIRING DIAGRAM

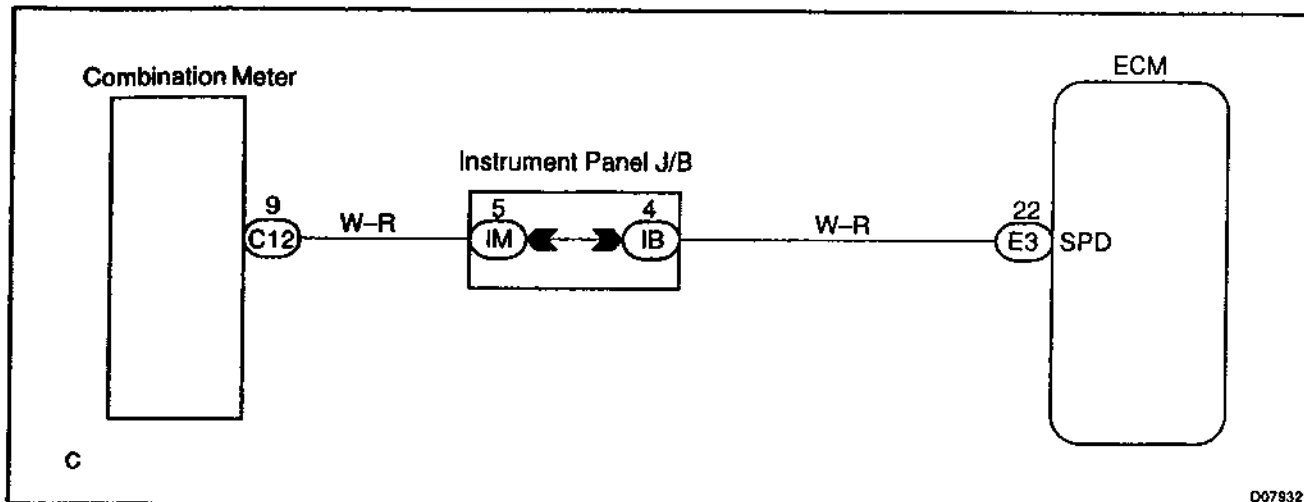

INSPECTION PROCEDURE

- | | |
|---|----------------------------------------|
| 1 | Check operation of speedometer. |
|---|----------------------------------------|

HINT:

Read freeze frame data using TOYOTA hand-held tester or OBD II scan tool. Because freeze frame records the engine conditions when the malfunction is detected. When troubleshooting it is useful for determining whether the vehicle was running or stopped, the engine was warmed up or not, the air-fuel ratio was lean or rich, etc. at the time of the malfunction.

CHECK:

Drive the vehicle and check if the operation of the speedometer in the combination meter is normal.

HINT:

The vehicle speed sensor is operating normally if the speedometer display is normal.

NG

Check speedometer (See page BE-2).

OK

- 2 Check for short in harness and connector between terminal SPD of ECM connector and body ground.**

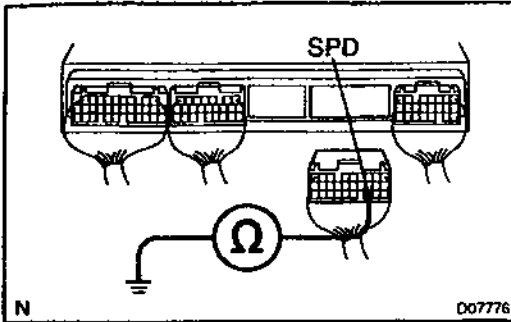
**PREPARATION:**

Disconnect the connector of the ECM.

CHECK:

Check continuity between terminal SPD of the ECM connector and body ground.

OK:

No continuity ($1M \Omega$ or higher)

NG

Repair or replace harness or connector.

OK

- 3 Check voltage between terminal SPD of ECM connector and body ground.**

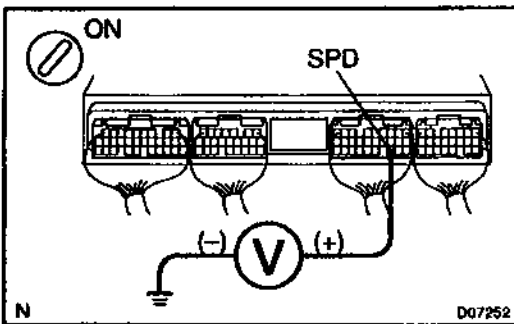
**PREPARATION:**

Turn ignition switch ON.

CHECK:

Measure voltage between terminal SPD of ECM connector and body ground.

OK:

Voltage: 9 – 14 V

NG

Check for open in harness and connector between instrument panel J/B and ECM (See page IN-30).

OK

- 4 Check for open in harness and connector between instrument panel J/B and combination meter (See page IN-30).**

NG

Repair or replace harness or connector.

5 Check ECM (See page IN-30).

NG Replace ECM.

OK

Check and repair transaxle (clutch, brake or gear etc.).

DTC	P0710	Transmission Fluid Temperature Sensor Malfunction (ATF Temperature Sensor)
------------	--------------	-----------------------------------------------------------------------------------

CIRCUIT DESCRIPTION

The ATF temperature sensor converts fluid temperature into a resistance value which is input into the ECM.

DTC No.	DTC Detecting Condition	Trouble Area
P0710	Either (a) or (b) is detected for 0.5 sec. or more. (2-trip detection logic) (a) Temperature sensor resistance is less than 79 Ω (b) After the engine has been operating for 15 minutes or more, the resistance at the temp. sensor is more than 156 k Ω	<ul style="list-style-type: none"> • Open or short in ATF temperature sensor • ATF temperature sensor • ECM

WIRING DIAGRAM

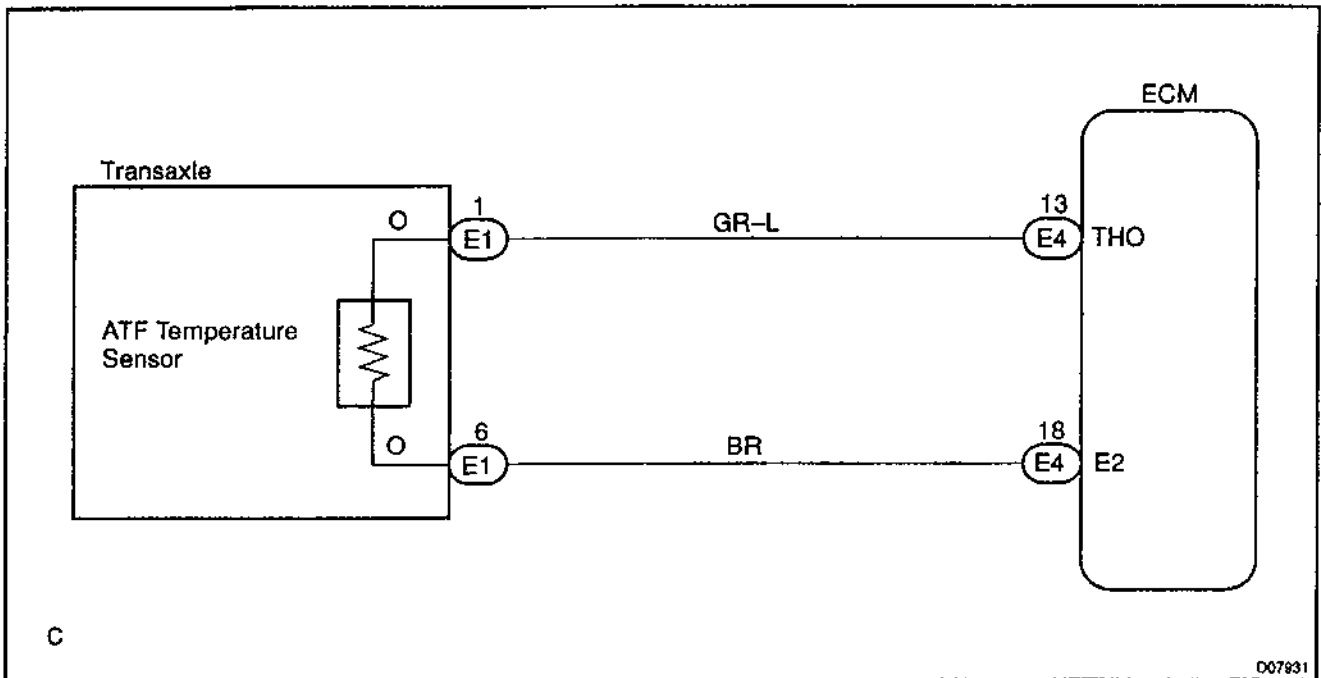

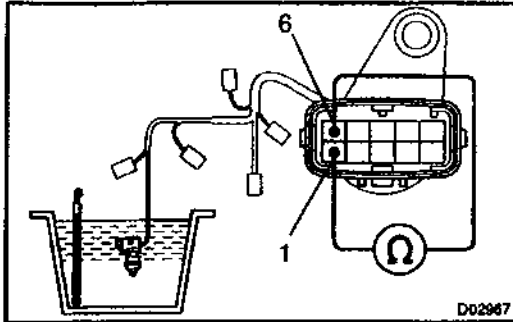
INSPECTION PROCEDURE**1 Check ATF temperature sensor.****PREPARATION:**

Remove the solenoid wiring (See page AX-9).

CHECK:

Measure resistance between terminals of ATF temperature sensor at 25 °C (77 °F) and 110 °C (230 °F).

OK:

Resistance (Approx.):

25 °C (77 °F): 3.5 kΩ

110 °C (230 °F): 247 Ω

NG**Replace the solenoid wiring.****OK****2 Check harness and connector between solenoid wiring and ECM (See page IN-30).****NG****Repair or replace the harness or connector.****OK**

Check and replace the ECM (See page IN-30).

DTC	P0750, P0755	Shift Solenoid A/B Malfunction (Shift Solenoid Valve No. 1/No. 2)
------------	---------------------	------------------------------------------------------------------------------

SYSTEM DESCRIPTION

The ECM uses signals from the vehicle speed sensor to detect the actual gear position (1st, 2nd, 3rd or O/D gear).

Then the ECM compares the actual gear with the shift schedule in the ECM memory to detect mechanical trouble of the shift solenoid valves and valve body.

DTC No.	DTC Detecting Condition	Trouble Area
P0750 P0755	During normal driving, the gear required by the ECM does not match the actual gear (2-trip detection logic)	<ul style="list-style-type: none"> • Shift solenoid valve No. 1/No. 2 is stuck open or closed • Valve body is blocked up or stuck

HINT:

Check the shift solenoid valve No. 1 when DTC P0750 is output and check the shift solenoid valve No. 2 when DTC P0755 is output.

INSPECTION PROCEDURE

1	Check shift solenoid valve No. 1 or No. 2 operation.
----------	-------------------------------------------------------------

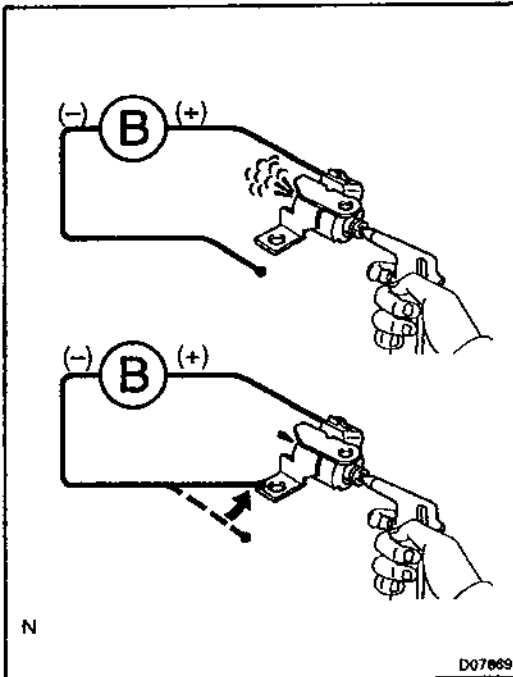

PREPARATION:

- (a) Remove the oil pan.
- (b) Remove the shift solenoid valve No. 1 or No. 2.

CHECK:

- (a) By applying 490 kPa (5 kgf/cm², 71 psi) of compressed air, check that the solenoid valve does not leak air.
- (b) When battery positive voltage is supplied to the shift solenoid valve, check that the valve opens.

OK:

- (a) Solenoid valve does not leak air.
- (b) Solenoid valve opens.

NG

Replace the shift solenoid valve No. 1 or No. 2.

OK

2	Check the valve body (See page DI-234).
----------	------------------------------------------------

NG	Repair or replace the valve body.
-----------	------------------------------------------

OK

Repair or replace the transaxle.

DTC	P0753,P0758	Shift Solenoid A/B Electrical Malfunction (Shift Solenoid Valve No. 1/No. 2)
------------	--------------------	-------------------------------------------------------------------------------------

CIRCUIT DESCRIPTION

Shifting from 1st to O/D is performed in combination with ON and OFF of the shift solenoid valve No. 1 and No. 2 controlled by ECM. If an open or short circuit occurs in either of the solenoid valves, the ECM controls the remaining normal solenoid valve to allow the vehicle to be operated smoothly (Fail safe function).

Range	NORMAL			SHIFT SOLENOID VALVE NO. 1 MALFUNCTIONING			SHIFT SOLENOID VALVE NO. 2 MALFUNCTIONING			BOTH SHIFT SOLENOID VALVES MALFUNCTIONING
	Solenoid valve		Gear	Solenoid valve		Gear	Solenoid valve		Gear	Gear when shift selector is manually operated
	No. 1	No. 2		No. 1	No. 2		No. 1	No. 2		
D	ON	ON	1st	X	ON	3rd	ON	X	1st	O/D
	ON	OFF	2nd	X	OFF	3rd	OFF	X	O/D	O/D
	OFF	OFF	3rd	X	OFF	3rd	OFF	X	O/D	O/D
	OFF	ON	O/D	X	ON	O/D	OFF	X	O/D	O/D
2	ON	ON	1st	X	ON	3rd	ON	X	1st	3rd
	ON	OFF	2nd	X	OFF	3rd	OFF	X	3rd	3rd
	OFF	OFF	3rd	X	OFF	3rd	OFF	X	3rd	3rd
L	ON	ON	1st	X	ON	1st	ON	X	1st	1st
	ON	OFF	2nd	X	OFF	2nd	ON	X	1st	1st

X: Malfunctions

HINT:

Check the shift solenoid valve No. 1 when DTC P0753 is output and check the shift solenoid valve No. 2 when DTC P0758 is output.

DTC No.	DTC Detecting Condition	Trouble Area
P0753/62 P0758/63	<p>The ECM checks for an open or short circuit in the shift solenoid valve No. 1/No. 2 circuit when it changes.</p> <p>The ECM records DTC P0753 or P0758 if condition (a) or (b) is detected once, but it does not blink the MIL</p> <p>After ECM detects condition (a) or (b) continuously 2 times or more in 1-trip, it causes the MIL to light up until condition (a) or (b) disappears.</p> <p>After that, if the ECM detects condition (a) or (b) once, it starts lighting up MIL again.</p> <p>(a) Solenoid resistance is 8 Ω or less (short circuit) when the solenoid is energized.</p> <p>(b) Solenoid resistance is 100 kΩ or more (open circuit) when the solenoid is not energized.</p>	<ul style="list-style-type: none"> • Open or short in shift solenoid valve No. 1/No. 2 circuit • Shift solenoid valve No. 1/No. 2 • ECM

Fail safe function:

If either of the solenoid valve circuits develops an open or short, the ECM turns the other solenoid valve ON and OFF to shift to the gear positions shown in the table above. The ECM also turns the shift solenoid valve ST OFF at the same time. If both solenoids malfunction, hydraulic control cannot be performed electronically and must be done manually.

Manual shifting as shown in the above table must be done (In the case of a short circuit, the ECM stops sending current to the short circuited solenoid).

WIRING DIAGRAM

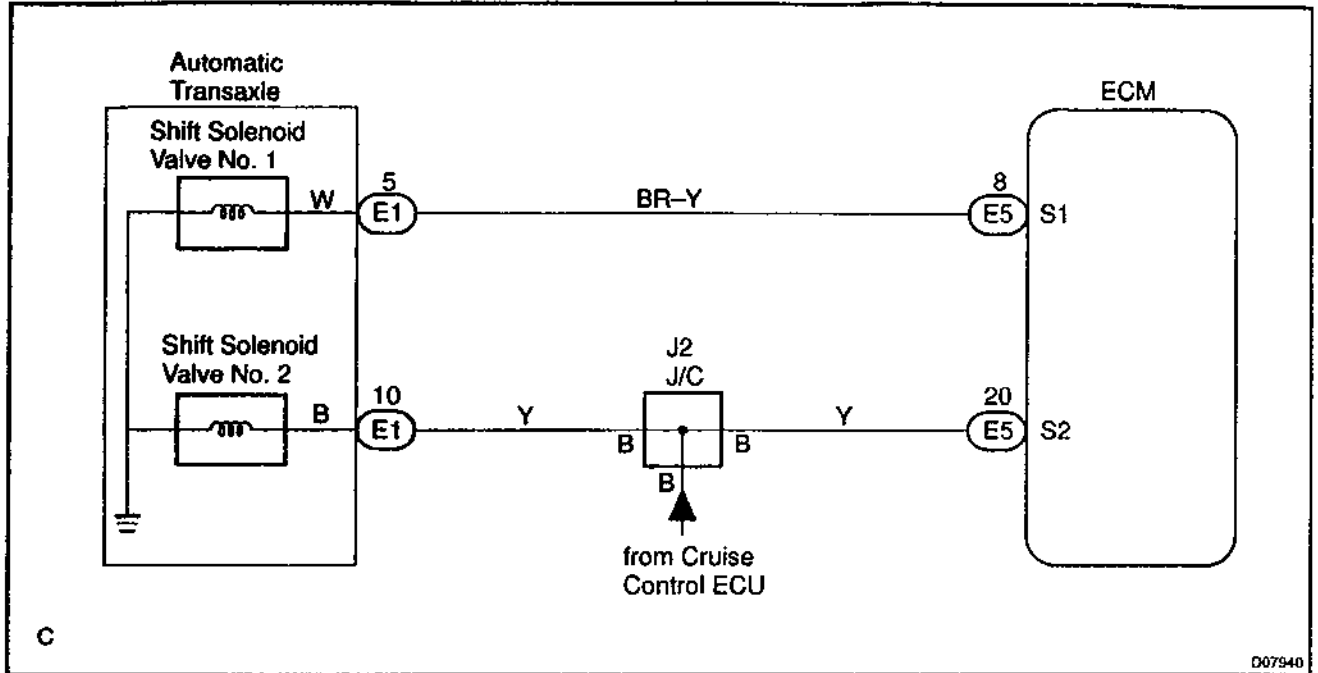

INSPECTION PROCEDURE

- 1 Measure resistance between terminal S1 or S2 of ECM and body ground.

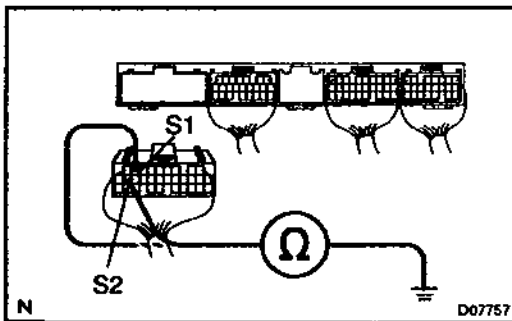

PREPARATION:

Disconnect the connector from ECM.

CHECK:

Measure resistance between terminal S1 or S2 of ECM and body ground.

OK:

Resistance: 11 - 15 Ω at 20 °C (68 °F)

OK

Check and replace the ECM (See page IN-30).

NG

2

Measure harness and connector between ECM and automatic transmission solenoid connector.

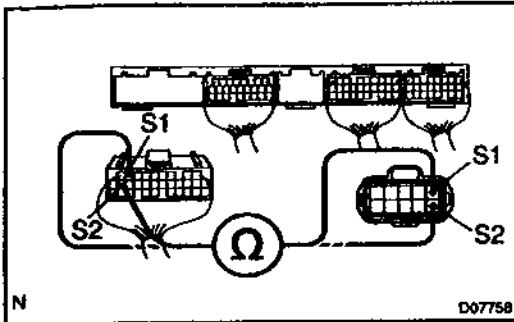
**PREPARATION:**

Disconnect the solenoid connector from the automatic trans-axle.

CHECK:

Measure the harness and connector between terminal S1 or S2 of ECM and terminal S1 or S2 of solenoid connector.

OK:

Resistance: 0 Ω

NG

Repair or replace the harness or connector (See page IN-30).

OK

3

Check connection of the connectors.

NG

Connect the connectors correctly.

OK

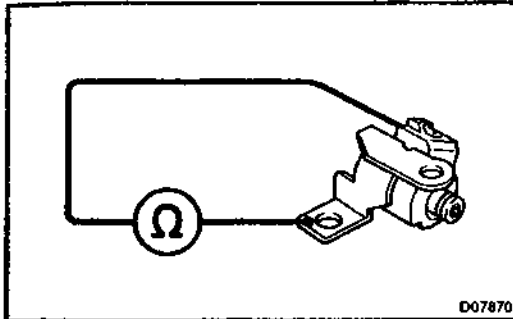
4 Check shift solenoid valve No. 1 or No. 2.**PREPARATION:**

- (a) Jack up the vehicle.
- (b) Remove the oil pan.
- (c) Disconnect the solenoid connector.
- (d) Remove the shift solenoid valve No. 1 or No. 2.

CHECK:

Measure resistance between solenoid connector and body ground.

OK:

Resistance: 11 – 15 Ω at 20 °C (68 °F)

NG**Replace the solenoid valve.****OK****Repair or replace the solenoid wire.**

DTC	P0770	Shift Solenoid E Malfunction (Shift Solenoid Valve SL)
------------	--------------	-------------------------------------------------------------------

SYSTEM DESCRIPTION

The ECM uses the signals from the throttle position sensor, air-flow meter and crankshaft position sensor to monitor the engagement condition of the lock-up clutch.

Then the ECM compares the engagement condition of the lock-up clutch with the lock-up schedule in the ECM memory to detect mechanical trouble of the shift solenoid valve SL, valve body and torque converter clutch or automatic transaxle (clutch, brake or gear etc.).

DTC No.	DTC Detecting Condition	Trouble Area
P0770	<ul style="list-style-type: none"> • Lock-up does not occur when driving in the lock-up range (normal driving at 80 km/h [50 mph]), or lock-up remains ON in the lock-up OFF range. (2-trip detection logic) • When lock-up is ON, clutch or brake slips or gear is broken. (2-trip detection logic) 	<ul style="list-style-type: none"> • Shift solenoid valve SL is stuck open or closed • Valve body blocked up or stuck • Lock-up clutch • Automatic transaxle (clutch, brake or gear etc.)

INSPECTION PROCEDURE

1	Check solenoid valve SL operation
----------	------------------------------------------

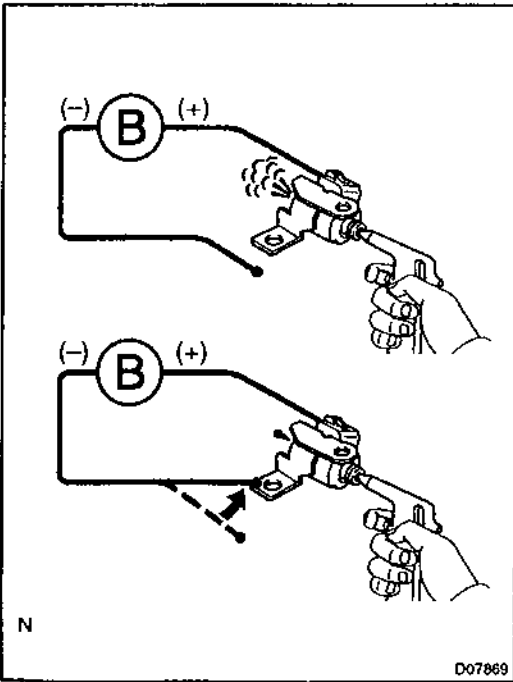

PREPARATION:

- (a) Remove the oil pan.
- (b) Remove the solenoid valve SL.

CHECK:

- (a) Applying 490 kPa (5 kgf/cm², 71 psi) of compressed air, check that the solenoid valve does not leak air.
- (b) When battery positive voltage is supplied to the shift solenoid valve, check that the solenoid valve opens.

OK:

- (a) Solenoid valve does leak air.
- (b) Solenoid valve opens.

NG	Replace the solenoid valve SL.
-----------	---------------------------------------



2	Check valve body (See page DI-234).
----------	--------------------------------------------

NG	Repair or replace the valve body.
-----------	------------------------------------------

OK

3	Check the torque converter clutch (See page AX-36).
----------	------------------------------------------------------------

NG	Repair the torque converter clutch.
-----------	--------------------------------------------

OK

Repair the transaxle (See page AX-30).

DTC	P0773	Shift Solenoid E Electrical Malfunction (Shift Solenoid Valve SL)
------------	--------------	------------------------------------------------------------------------------

CIRCUIT DESCRIPTION

The shift solenoid valve SL is turned ON and OFF by signals from the ECM to control the hydraulic pressure acting on the lock-up relay valve, which then controls operation of the lock-up clutch.

Fail safe function:

If the ECM detects a malfunction, it turns the shift solenoid valve SL OFF.

DTC No.	DTC Detecting Condition	Trouble Area
P0773	Either (a) or (b) is detected for 1 time. (2-trip detection logic) (a) Solenoid resistance is 8 Ω or less when solenoid is energized. (b) Solenoid resistance is 100 k Ω or more when solenoid is not energized.	<ul style="list-style-type: none"> • Open or short in shift solenoid valve SL circuit • Shift solenoid valve SL • ECM

WIRING DIAGRAM

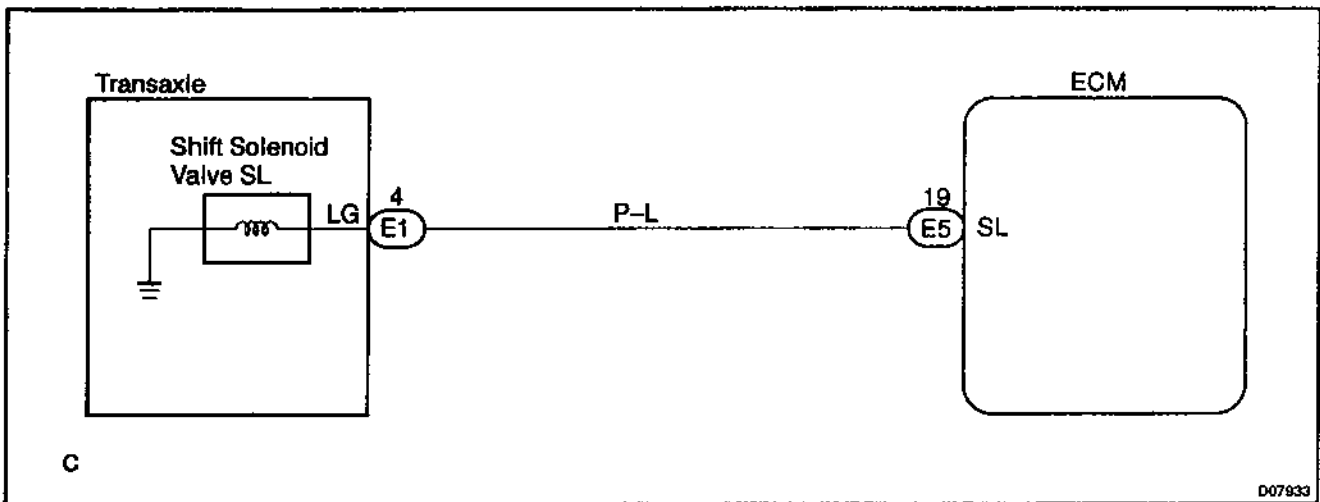

INSPECTION PROCEDURE

- 1 Measure resistance between terminal SL of ECM and body ground.**

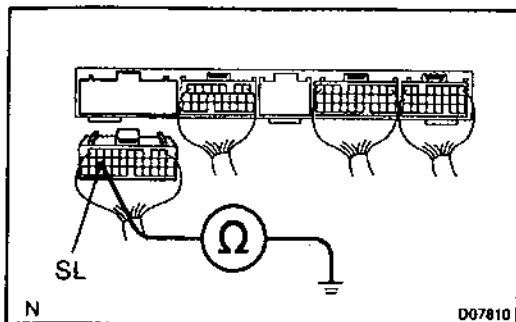
**PREPARATION:**

Disconnect the connector from ECM.

CHECK:

Measure resistance between terminal SL of ECM and body ground.

OK:

Resistance: 11 – 15 Ω at 20 °C (68 °F)

OK

Check and replace the ECM (See page IN-30).

NG

- 2 Measure resistance of harness and connector between ECM and automatic transaxle solenoid connector.**

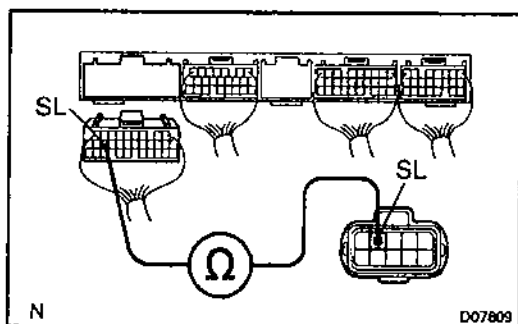
**PREPARATION:**

Disconnect the solenoid connector from the transaxle.

CHECK:

Measure resistance of the harness and connector between terminal SL of ECM and terminal SL of solenoid connector.

OK:

Resistance: 0 Ω

NG

Repair or replace the harness or connector.

OK

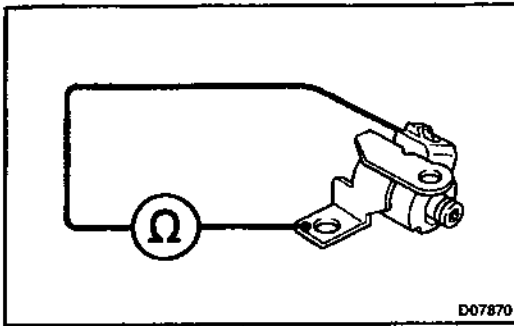
3 Check shift solenoid valve SL.**PREPARATION:**

- (a) Jack up the vehicle.
- (b) Remove the oil pan.
- (c) Disconnect the shift solenoid valve SL connector.
- (d) Remove the shift solenoid valve SL.

CHECK:

Measure resistance between terminal SL of shift solenoid valve and solenoid body.

OK:

Resistance: 11 – 15 Ω at 20 °C (68 °F)

NG**Replace the shift solenoid valve SL.****OK**

Replace or repair the solenoid wire, harness and connector between ECM and automatic transaxle solenoid connector.

DTC	P1520	Stop Light Switch Signal Malfunction
------------	--------------	---------------------------------------------

CIRCUIT DESCRIPTION

The purpose of this circuit is to prevent the engine from stalling, while driving in lock-up condition, when brakes are suddenly applied.

When the brake pedal is operated, this switch sends a signals to ECM. Then the ECM cancels operation of the lock-up clutch while braking is in progress.

DTC No.	DTC Detecting Condition	Trouble Area
P1520	No stop light switch signal to ECM during driving. (2-trip detection logic)	<ul style="list-style-type: none"> • Open or short in stop light switch circuit • Stop light switch • ECM

WIRING DIAGRAM

See page DI-130.

INSPECTION PROCEDURE

See page DI-130.

DTC	P1725	NT Revolution Sensor Circuit Malfunction (Input Turbine Speed Sensor)
------------	--------------	----------------------------------------------------------------------------------

CIRCUIT DESCRIPTION

This sensor detects the rotation speed of the input turbine. By comparing the input turbine speed signal (NT) and the counter gear speed sensor signal (NC), the ECM detects the shift timing of the gears and appropriately controls the engine torque and hydraulic pressure in response to various conditions, thus performing smooth gear shifting.

DTC No.	DTC Detecting Condition	Trouble Area
P1725	<p>The ECM detects conditions (a), (b), (c), (d) and (e) continuity for 5 secs or more. (1-trip detection logic)</p> <p>(a) Gear change not being performed (b) Gear position: 2nd, 3rd or O/D gear (c) Solenoid valves and park/neutral position switch are normal (d) T/M input shaft rpm: 300 rpm or less (e) T/M output shaft rpm: 1,000 rpm or more</p>	<ul style="list-style-type: none"> • Open or short in input turbine (NT) speed sensor circuit • Input turbine (NT) speed sensor • ECM

WIRING DIAGRAM

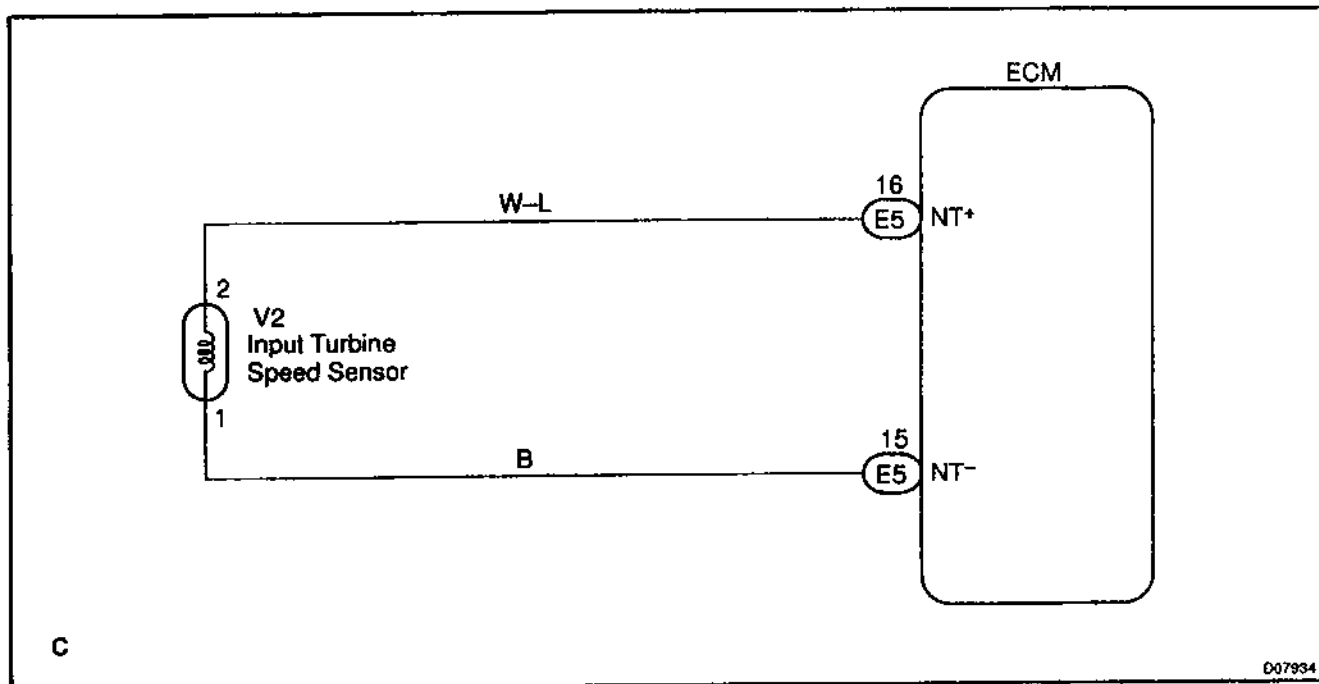

INSPECTION PROCEDURE

- 1 Check resistance between terminals NT⁺ and NT⁻ of ECM.**

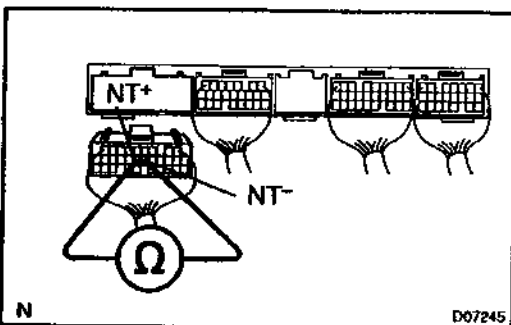
**PREPARATION:**

Disconnect the connector from ECM.

CHECK:

Check resistance between terminals NT⁺ and NT⁻ of ECM.

OK:

Resistance: $620 \pm 60 \Omega$

OK

Check and replace the ECM.

NG

- 2 Check NT revolution sensor.**

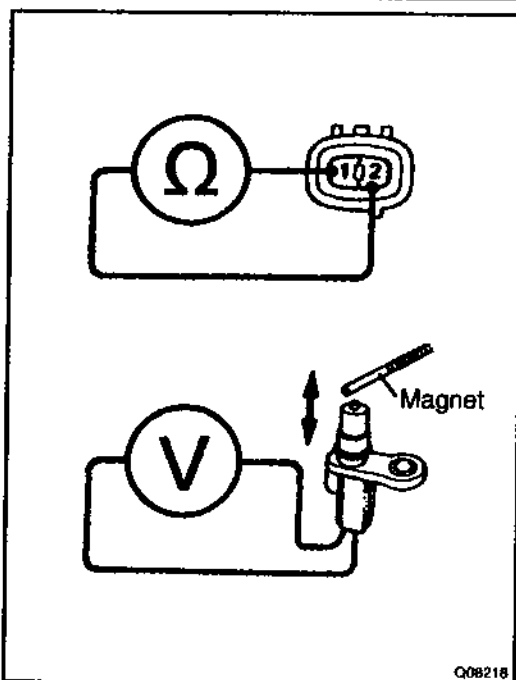
**PREPARATION:**

Remove the NT revolution speed sensor from transaxle.

CHECK:

- Measure resistance between terminals 1 and 2 of speed sensor.
- Check voltage between terminals 1 and 2 of the speed sensor when a magnet is put close to the front end of the speed sensor then taken away quickly.

OK:

(a) Resistance: $620 \pm 60 \Omega$ at 20°C (68°F)

(b) Voltage is generated Intermittently.

HINT:

The generated voltage is extremely low.

NG

Replace the NT input shaft speed sensor.

OK

Check and repair the harness and connector between ECM and Turbine speed sensor (See page IN-30).

DTC	P1760	Linear Solenoid for Line Pressure Control Circuit Malfunction (Solenoid valve SLT)
------------	--------------	-------------------------------------------------------------------------------------------

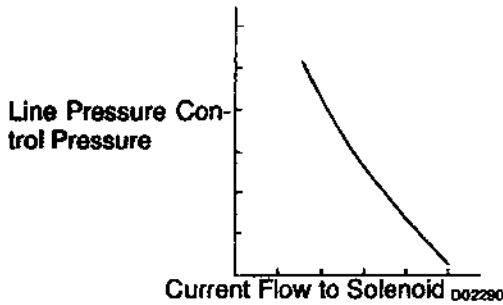

CIRCUIT DESCRIPTION

The throttle pressure that is applied to the primary regulator valve (which modulates line pressure) causes the shift solenoid valve SLT, under electronic control, to precisely and minutely modulate and generate line pressure according to the accelerator pedal effort, or engine power output detected.

This reduces the function of line pressure and provides smooth shifting characteristics.

Upon receiving the throttle valve opening angle signal, ECM controls the line pressure by sending a predetermined (*) duty ratio to the solenoid valve, modulating the line pressure, generating throttle pressure.

(*) Duty Ratio

The duty ratio is the ratio of the period of continuity in one cycle. For example, if A is the period of continuity in one cycle, and B is the period of non-continuity, then

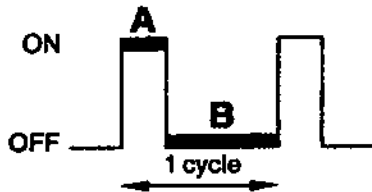

BE4056

$$\text{Duty Ratio} = \frac{A}{A + B} \times 100 (\%)$$

DTC No.	DTC Detecting Condition	Trouble Area
P1760/77	(a) or (b) condition below is detected 1 second or more. (a) SLT ⁻ terminal: 0V (b) SLT ⁻ terminal: 12V	<ul style="list-style-type: none"> • Open or short in shift solenoid valve SLT circuit • Shift solenoid valve SLT • ECM

HINT:

Refer to the chart for the wave form between terminals SLT⁺ and SLT⁻ during engine idling.

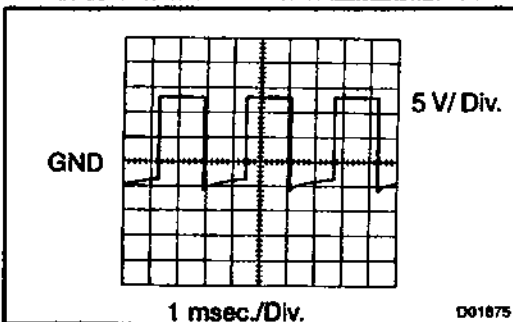

WIRING DIAGRAM

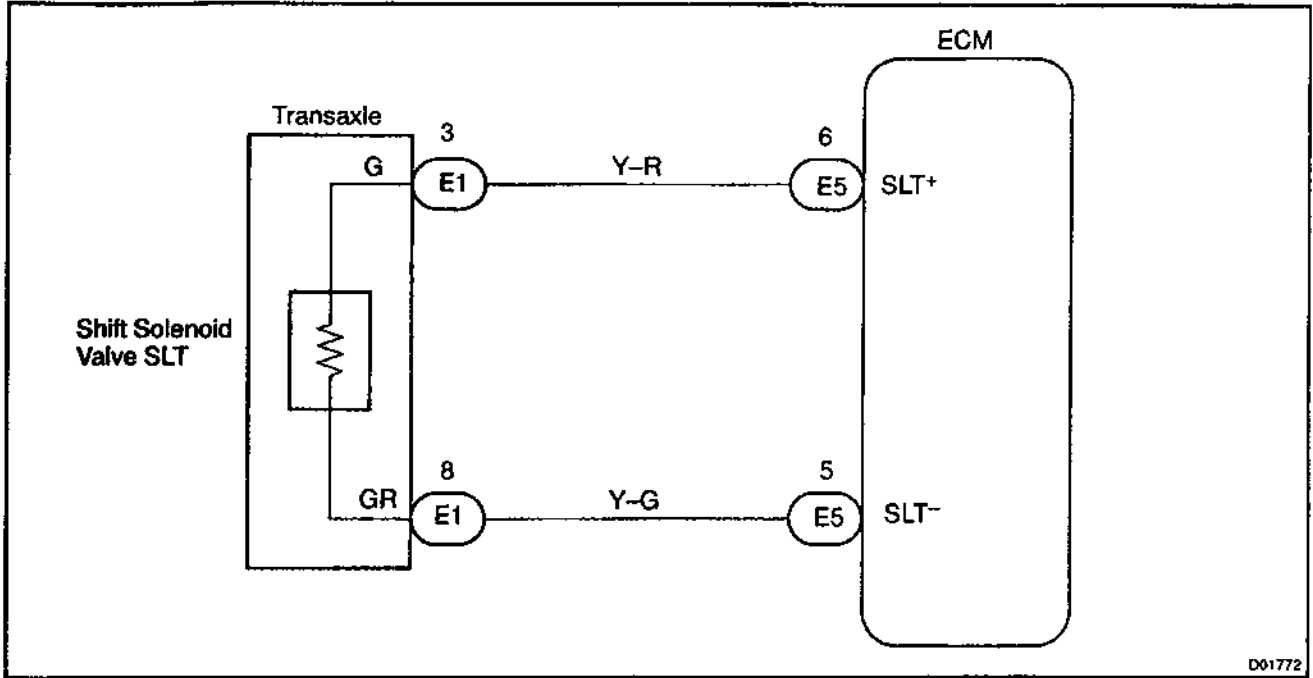

INSPECTION PROCEDURE

1 Check shift solenoid valve SLT.

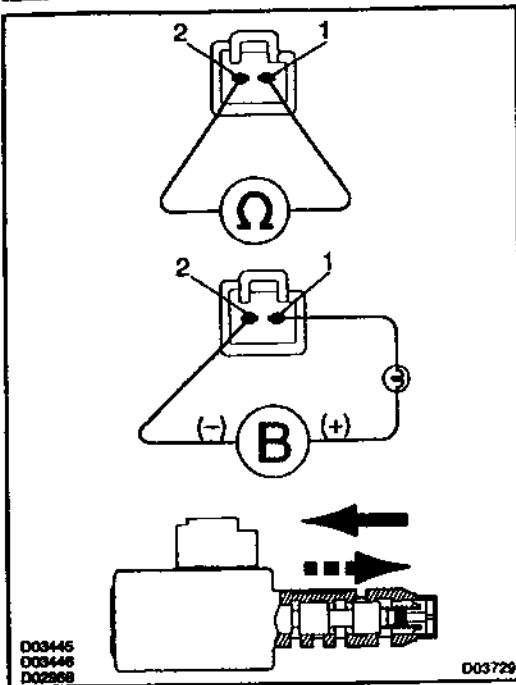
**PREPARATION:**

- Jack up the vehicle.
- Remove the oil pan.
- Disconnect the solenoid connector.

Check solenoid resistance:**CHECK:**

Measure resistance between terminals 1 and 2 of solenoid connector.

OK:

Resistance: 5.0 – 5.6 Ω at 20 °C (68 °F)



Check solenoid operation:**CHECK:**

Connect positive (+) lead with an 5 – 6 W bulb to terminal 1 of solenoid connector and negative (–) lead to terminal 2, then check the movement of the valve.

HINT:

The solenoid valve operates with the current of 0.9 – 1.0 A.

OK:

When battery positive voltage is applied.	Valve moves in  direction in illustration.
When battery positive voltage is cut off.	Valve moves in  direction in illustration.

NG

Replace SLT solenoid valve.

OK

2

Check harness and connector between shift solenoid valve SLT and ECM (See page IN-30).

NG

Repair or replace harness or connector.

OK

Replace ECM (See page IN-30).

DTC	P1780	Neutral Start Switch Malfunction
------------	--------------	-----------------------------------------

CIRCUIT DESCRIPTION

The neutral start switch detects the shift lever position and sends signals to the ECM.

The ECM receives signals (P, R, N, D, 2 and L) from the park/neutral position switch.

DTC No.	DTC Detecting Condition	Trouble Area
P1780	<p>When more than one of the following conditions continue for 500 sec. or more.</p> <p>(a) P, N position input signal is ON. (b) P position input signal is ON. (c) N position input signal is ON. (d) L position input signal is ON. (e) 2 position input signal is ON. (f) 3 position input signal is ON. (g) 4 position input signal is ON. (h) D position input signal is ON. (i) R position input signal is ON.</p> <p>When any of following conditions for 500 msec. or more in the M position.</p> <p>(a) P, N position input signal is ON. (b) P position input signal is ON. (c) N position input signal is ON. (d) L position input signal is ON.</p>	<ul style="list-style-type: none"> • Shot in park/neutral position switch circuit • Park/neutral position switch • ECM

WIRING DIAGRAM

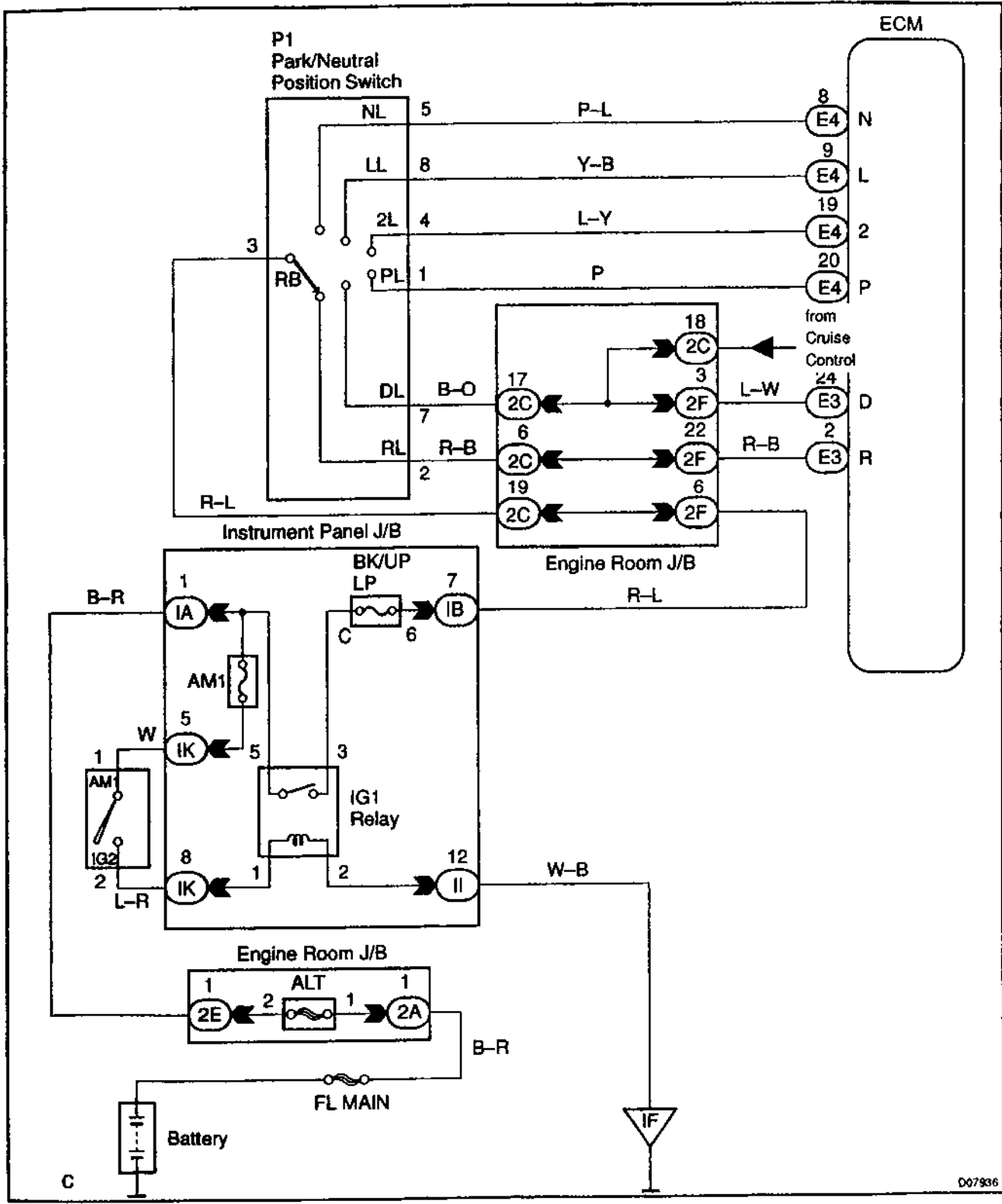

INSPECTION PROCEDURE

1 Read PNP, REVERSE, 2ND and LOW signals.

When using TOYOTA hand-held tester:

PREPARATION:

- (a) Connect a hand-held tester to the DLC3.
- (b) Turn the ignition switch ON and TOYOTA hand-held tester main switch ON.

CHECK:

Shift lever into the P, R, N, 2 and L positions, and read the NSW, REVERSE, 2ND and LOW signals on the hand-held tester.

OK:

Shift range	Signal
2	2ND OFF → ON
L	LOW OFF → ON
R	REVERSE OFF → ON
P, N	NSW OFF → ON

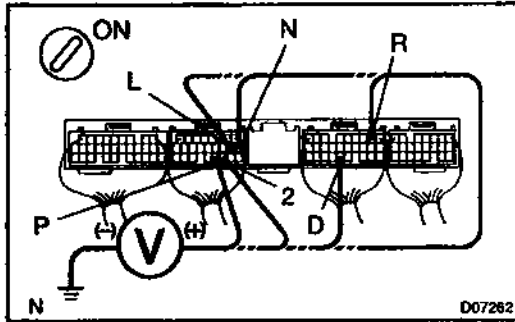

When not TOYOTA using hand-held tester:

PREPARATION:

Turn the ignition switch ON.

CHECK:

Measure voltage between each of terminals P, R, N, D, 2 and L of ECM and body ground when the shift lever is shifted to the following positions.

OK:

Position	P-Body ground	R-Body ground	N-Body ground	D-Body ground	2-Body ground	L-Body ground
P	9-14 V	0 V	0 V	0 V	0 V	0 V
R	0 V	9-14 V	0 V	0 V	0 V	0 V
N	0 V	0 V	9-14 V	0 V	0 V	0 V
D	0 V	0 V	0 V	9-14 V	0 V	0 V
2	0 V	0 V	0 V	0 V	9-14 V	0 V
L	0 V	0 V	0 V	0 V	0 V	9-14 V

HINT:

*: The voltage will drop slightly due to lighting up of the back up light.

OK Check and replace the ECM.

NG

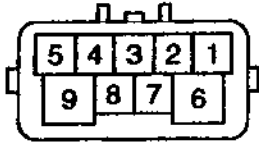
2 Check park/neutral position switch.

N

D05601

PREPARATION:

Remove the park/neutral position switch.

CHECK:

Check continuity between each terminal shown below when the shift lever is moved to each position.

Shift position	Terminal No. to continuity	
P	1 - 3	6 - 9
R	2 - 3	-
N	3 - 5	6 - 9
D	3 - 7	-
2	3 - 4	-
L	3 - 8	-

OK:

There is continuity.

NG

Replace the park/neutral position switch.

OK

3 Check harness and connector between battery and park/neutral position switch, park/neutral position switch and ECM (See page IN-30).

NG

Repair or replace the harness and connector.

OK

Check and replace the ECM (See page IN-30).

DTC	P1790	ST Solenoid Valve Circuit Malfunction
------------	--------------	----------------------------------------------

CIRCUIT DESCRIPTION

Shift solenoid valve ST is switched ON-OFF by a signal from ECM so that let in or out timing of 2nd brake is adjusted by operating orifice control valve. Therefore, ST solenoid operates when letting in or out reverse clutch.

If it is broken, the shift shock becomes big.

DTC No.	DTC Detecting Condition	Trouble Area
P1790	ECU memorizes DTC P1790 if (a) or (b) condition below is detected once or more, but ECU does not start MIL blinking. (a) Solenoid resistance is 30 Ω or lower (short circuit) when solenoid energized. (b) Solenoid resistance is 100 k Ω or higher (open circuit) when solenoid is not energized.	<ul style="list-style-type: none"> • Open or short in shift solenoid valve ST circuit • Shift solenoid valve ST • MIL

WIRING DIAGRAM

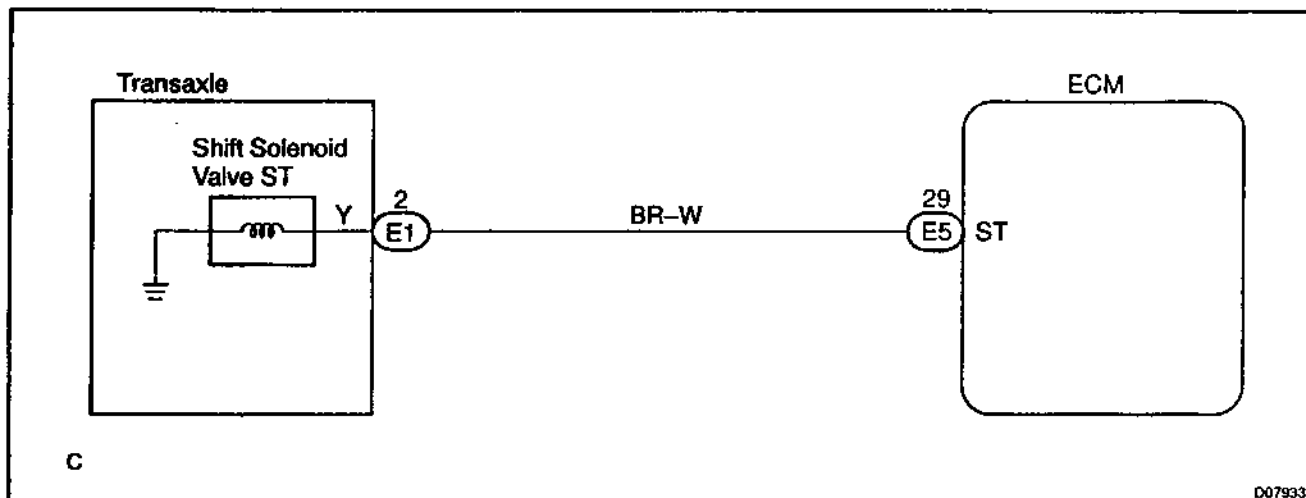

INSPECTION PROCEDURE

- 1 Measure resistance between terminal ST of ECM and body ground.

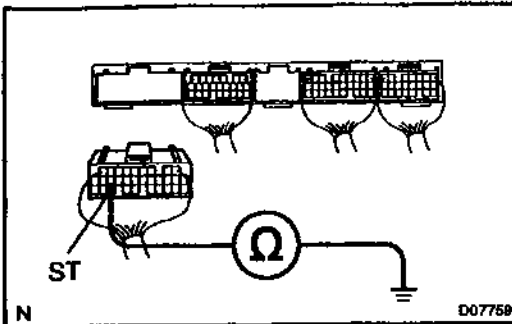
**PREPARATION:**

Disconnect the connector from ECM.

CHECK:

Measure resistance between terminal ST of ECM and body ground.

OK:

Resistance: 11 – 15 Ω at 20 °C (68 °F)

OK

Check and replace the ECM See page IN-30).

NG

- 2 Measure harness and connector between ECM and automatic transaxle solenoid connector.

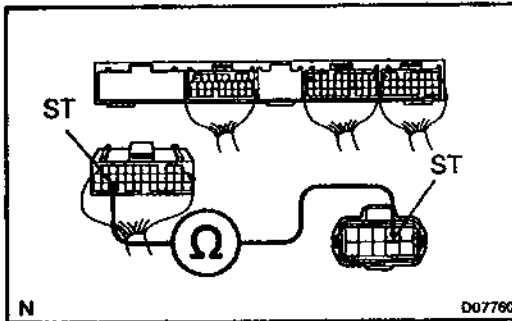
**PREPARATION:**

Disconnect the solenoid connector from the automatic transaxle.

CHECK:

Measure the harness and connector between terminal ST of ECM and terminal ST of solenoid connector.

OK:

0 Ω

NG

Repair or replace the harness or connector.

OK

- 3 Check connection of the connectors.

NG

Connect the connectors correctly.

OK

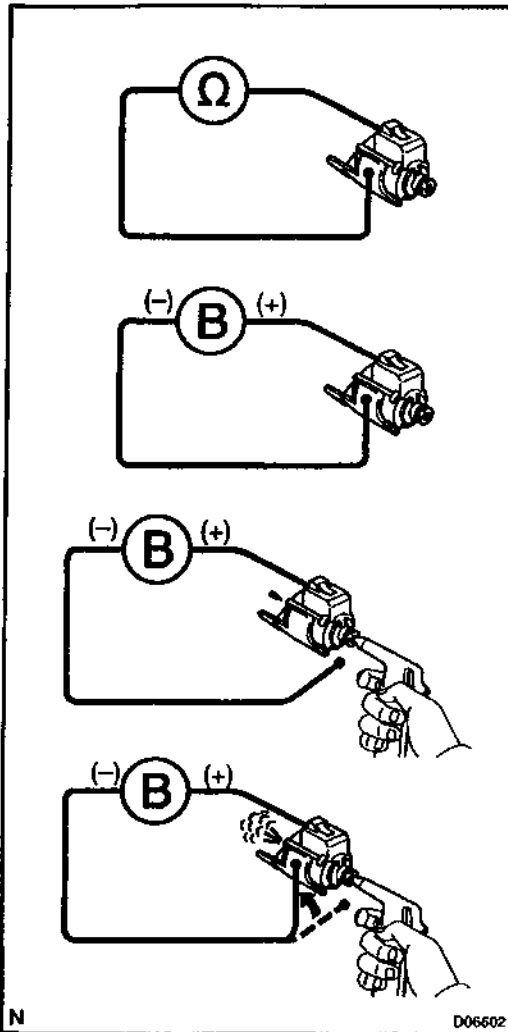
4 Check shift solenoid valve ST.

Electrical check:
PREPARATION:

- Jack up the vehicle.
- Remove the oil pan.
- Disconnect the solenoid connector.
- Remove the shift solenoid valve ST.

CHECK:

- Measure resistance between solenoid connector and body ground.
- Connect positive ⊕ lead to terminal of solenoid connector, negative ⊖ lead to solenoid body.

OK:

- Resistance: 11 – 15 Ω at 20 °C (68 °F)
- The solenoid makes an operating noise.

Mechanical check:
PREPARATION:

- Jack up the vehicle.
- Remove the oil pan.
- Disconnect the solenoid connector.
- Remove the shift solenoid valve ST.

CHECK:

- Applying 490 kPa (5 kgf/cm², 71 psi) of compressed air, check that the solenoid valves do not leak air.
- When battery positive voltage is supplied to the shift solenoid valves, check that the solenoid valve opens.

OK:

- Solenoid valve does not leak air.
- Solenoid valve opens.

NG
Replace the solenoid valve.
OK
Repair or replace the solenoid wire.

O/D Main Switch & O/D OFF Indicator Light Circuit

CIRCUIT DESCRIPTION

The O/D main switch is a momentary type switch. When pressing the O/D main switch, the O/D OFF indicator light lights up and ECM prohibits shifting to O/D, and when pressing it again, the O/D OFF indicator light goes off and ECM allows shifting to O/D. Turning the IG switch OFF will reset the O/D OFF indicator light.

WIRING DIAGRAM

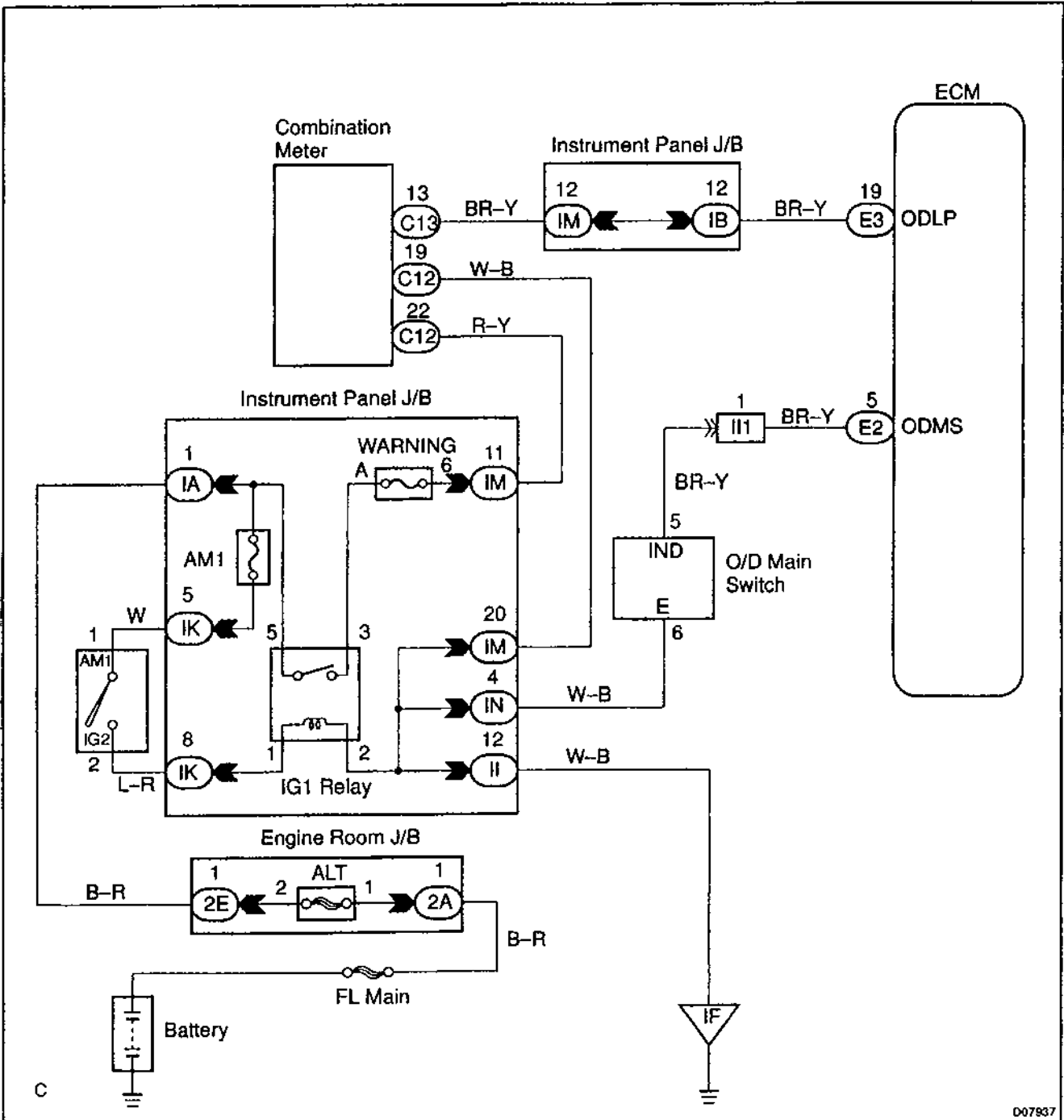

INSPECTION PROCEDURE**1 Check operation of O/D main switch.****PREPARATION:**

Turn the ignition switch ON.

CHECK:

- (a) Check O/D OFF indicator light when O/D main switch is pushed in to ON.
- (b) Check O/D OFF indicator light when O/D main switch is pushed again.

OK:

- (a) O/D OFF indicator light lights up.
- (b) O/D OFF indicator light goes off.

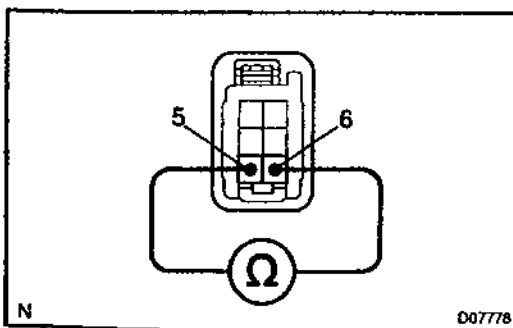
OK**Proceed to next inspection shown on problem symptoms tables (See page DI-234).****NG****2 Check and replace the combination meter (See page BE-2).****NG****Replace the combination meter.****OK****3 Check O/D main switch.****PREPARATION:**

Disconnect the O/D main switch connector.

CHECK:

Check continuity between terminals 5 and 6 of O/D main switch connector.

OK:

O/D main switch condition	Specified condition
Press continuously O/D main switch	Continuity
Release O/D main switch	No continuity

NG**Replace and repair O/D main switch.****OK**

4

Check voltage between terminal ODMS of ECM and body ground.

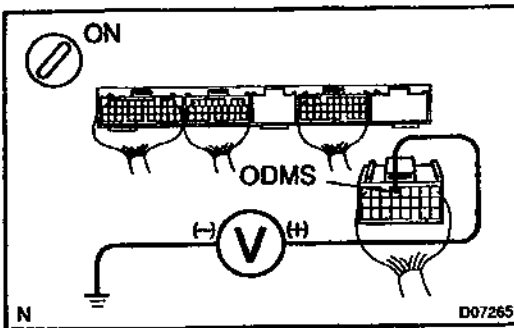
**PREPARATION:**

Turn the ignition switch ON.

CHECK:

Check voltage between terminal ODMS of ECM and body ground when O/D main switch is ON and OFF.

OK:

O/D main switch	Specified voltage
Press continuously O/D main switch	Below 1.0 V
Release O/D main switch	10 - 14 V

OK

Check and replace the ECM (See page IN-30).

NG

5

Check voltage between terminal ODLP of ECM and body ground.

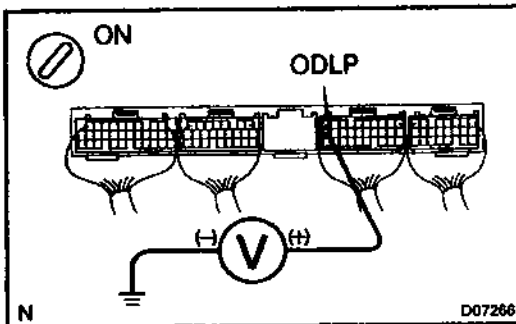
**PREPARATION:**

(a) Disconnect the connector of ECM.

(b) Turn the ignition switch ON.

CHECK:

Check voltage between terminal ODLP of ECM and body ground.

OK:

Voltage: 7.5 - 14 V

OK

Check and replace the ECM (See page IN-30).

NG

Check and replace harness and connector between combination meter and ECM, O/D main switch and ECM, O/D main switch and body ground (See page IN-30).

O/D Cancel Signal Circuit

CIRCUIT DESCRIPTION

While driving uphill with cruise control activated, in order to minimize gear shifting and provide smooth cruising overdrive may be prohibited temporarily under some condition.

The cruise control ECU sends O/D cut signals to the ECM as necessary and the ECM cancels overdrive shifting until these signals are discontinued.

WIRING DIAGRAM

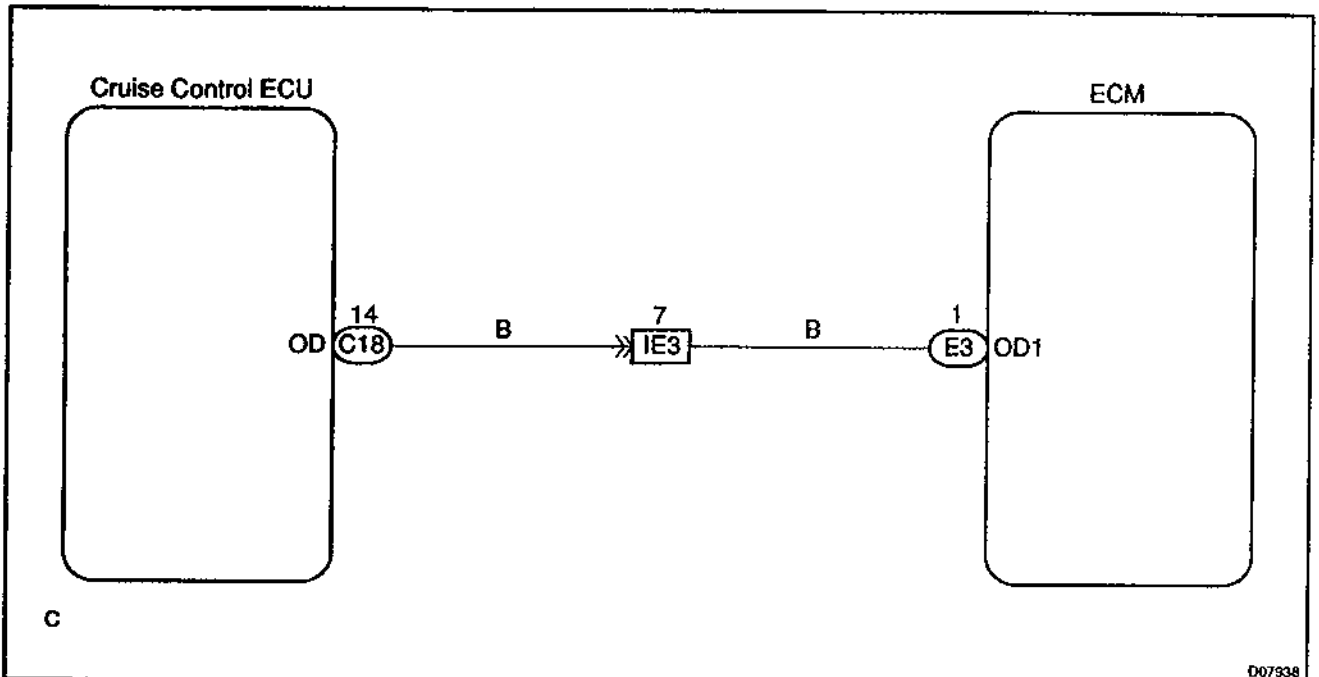

INSPECTION PROCEDURE

- 1 Check voltage between terminal OD1 of ECM and body ground.**

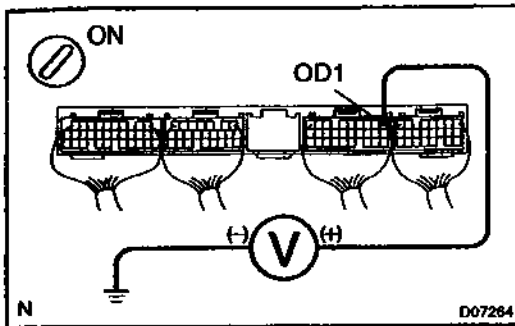
**PREPARATION:**

Turn the ignition switch ON.

CHECK:

Measure voltage between terminal OD1 of ECM and body ground.

OK:

Voltage: 10 – 14 V

OK

Proceed to next circuit inspection shown on problem symptoms table (See page DI-234).

NG

- 2 Check voltage between terminal OD of cruise control ECU harness side connector and body ground.**

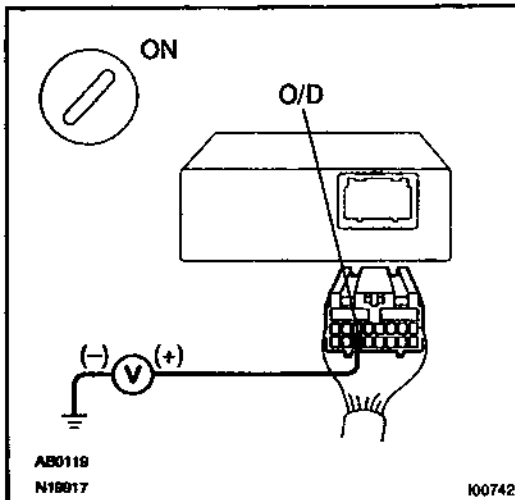
**PREPARATION:**

(a) Disconnect the cruise control ECU connector.

(b) Turn the ignition switch ON.

CHECK:

Measure voltage between terminal OD of cruise control ECU harness side connector and body ground.

OK:

Voltage: 10 – 14 V

OK

Check and replace the cruise control ECU.

NG

3	Check harness and connector between cruise control ECU and ECM (See page IN-30).
---	---------------------------------------------------------------------------------------------

NG

Repair or replace the harness or connector.

OK

**Check and replace the ECM
(See page IN-30).**

ANTI-LOCK BRAKE SYSTEM WITH ELECTRONIC BRAKE FORCE DISTRIBUTION (EBD)

HOW TO PROCEED WITH TROUBLESHOOTING

DIAG-01

Troubleshoot in accordance with the procedure on the following pages.

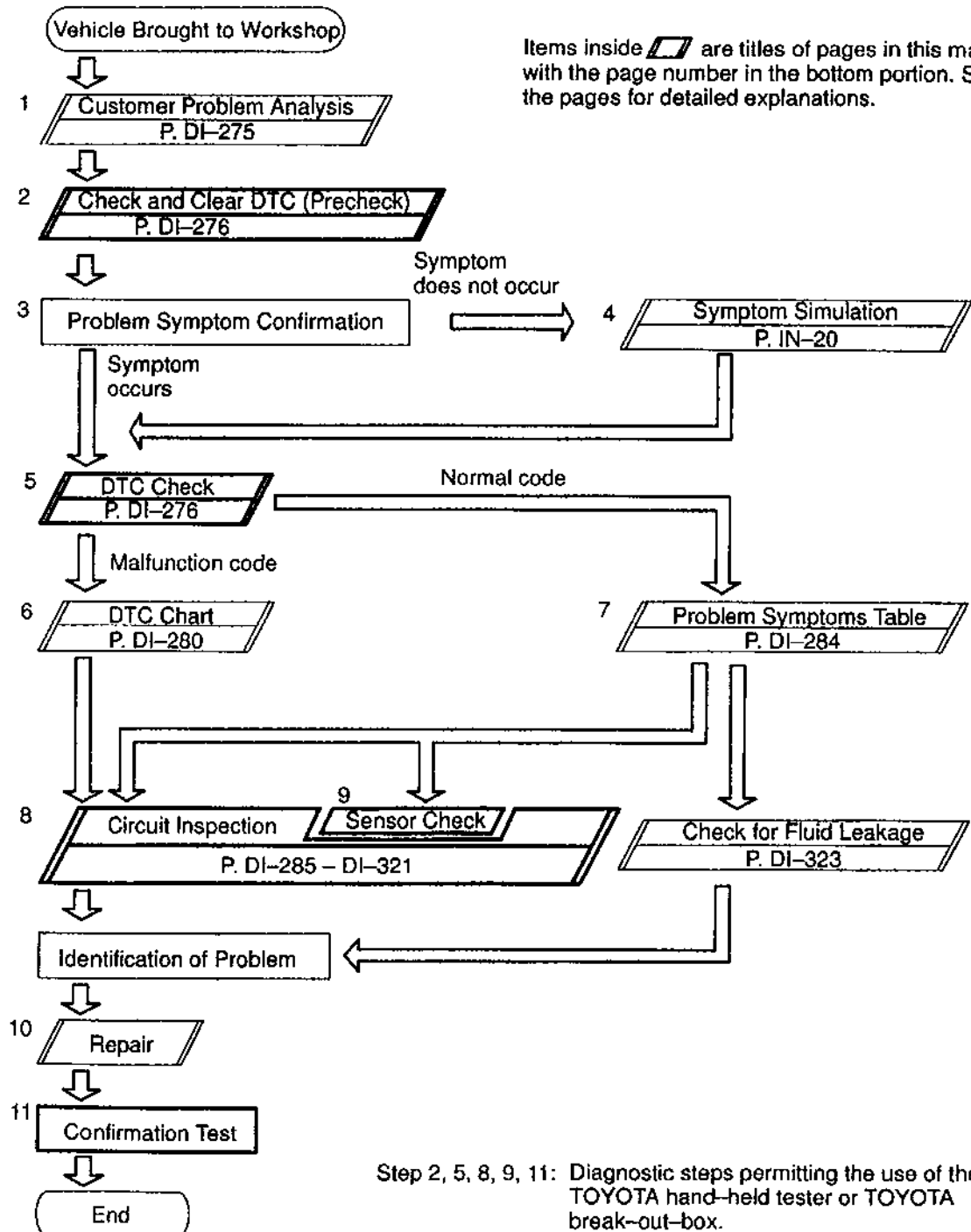

Fail safe function:

When a failure occurs in the ABS system, the ABS warning light is lit and the ABS operation is prohibited. In addition to this, when the failure which disables the EBD operation occurs, the brake warning light is lit as well and the EBD operation is prohibited.

CUSTOMER PROBLEM ANALYSIS CHECK

ABS Check Sheet

Inspector's Name _____

Customer's Name	Registration No.	
	Registration Year	/ /
	Frame No.	
Date Vehicle Brought In	/ /	Odometer Reading km miles

Date Problem First Occurred	/ /
Frequency Problem Occurs	<input type="checkbox"/> Continuous <input type="checkbox"/> Intermittent (times a day)

Symptoms	<input type="checkbox"/> ABS does not operate.	
	<input type="checkbox"/> ABS does not operate efficiently.	
	ABS Warning Light Abnormal	<input type="checkbox"/> Remains ON <input type="checkbox"/> Does not Light Up
	BRAKE Warning Light Abnormal	<input type="checkbox"/> Remains ON <input type="checkbox"/> Does not Light Up

DTC Check	1st Time	<input type="checkbox"/> Normal Code <input type="checkbox"/> Malfunction Code (Code)
	2nd Time	<input type="checkbox"/> Normal Code <input type="checkbox"/> Malfunction Code (Code)

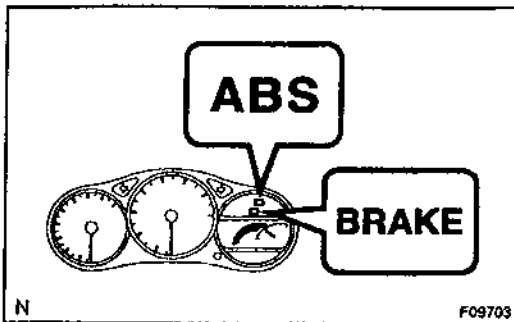

PRE-CHECK

1. DIAGNOSIS SYSTEM

- (a) Release the parking brake lever.
- (b) Check the indicator.

When the ignition switch is turned ON, check that the ABS warning light and BRAKE warning light goes on for approx. 3 seconds.

HINT:

- When the parking brake is applied or the level of the brake fluid is low, the BRAKE warning light is lit.
 - If the indicator check result is not normal, proceed to troubleshooting for the ABS warning light circuit or BRAKE warning light circuit (See page DI-314 or DI-317).
- (c) In case of not using TOYOTA hand-held tester: Check the DTC.

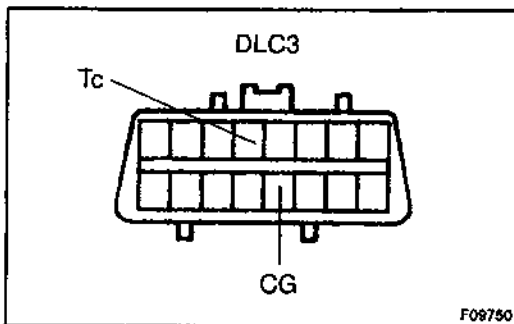

(1) Using SST, connect terminals Tc and CG of DLC3.
SST 09843-18040

(2) Turn the ignition switch ON.

(3) Read the DTC from the ABS warning light on the combination meter.

HINT:

- If no code appears, inspect the diagnostic circuit or ABS warning light circuit (See page DI-319 or DI-314).

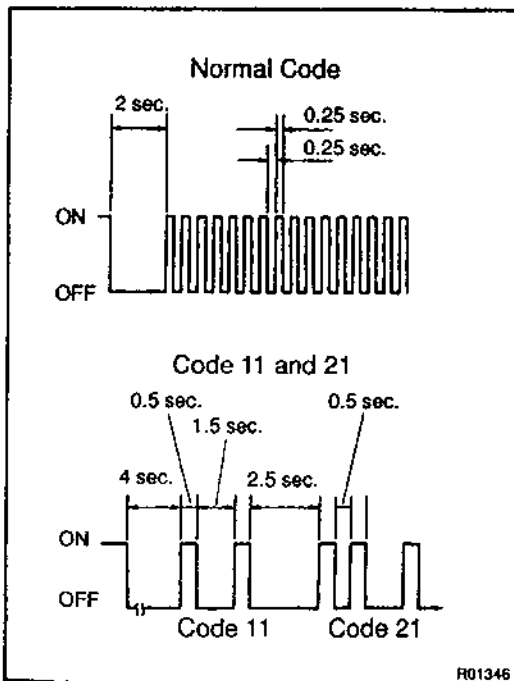

- As an example, the blinking patterns for normal code and codes 11 and 21 are shown on the left.

(4) Codes are explained in the code table on page DI-280.

(5) After completing the check, disconnect terminals Tc and E₁, and turn off the display.

If 2 or more malfunctions are indicated at the same time the lowest numbered DTC will be displayed 1st.

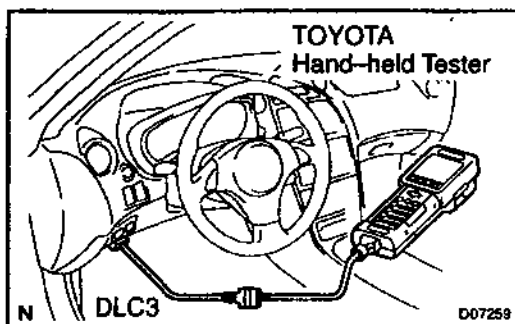

- (d) In case of using TOYOTA hand-held tester:
Check the DTC.
- (1) Hook up the TOYOTA hand-held tester to the DLC3.
 - (2) Turn the ignition switch ON.
 - (3) Read the DTC by following the prompts on the tester screen.
- Please refer to the TOYOTA hand-held tester operator's manual for further details.

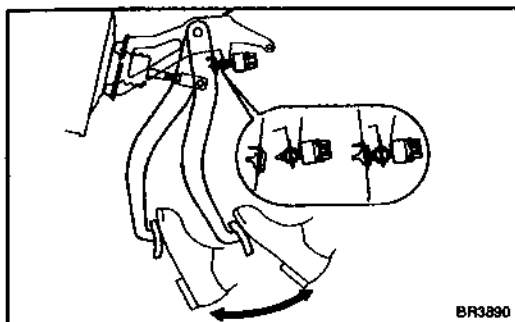

- (e) In case of not using TOYOTA hand-held tester:
Clear the DTC.
- (1) Using SST, connect terminals Tc and CG of DLC3.
SST 09843-18040
 - (2) Turn the ignition switch ON.
 - (3) Clear the DTC stored in ECU by depressing the brake pedal 8 or more times within 5 seconds.
 - (4) Check that the warning light shows the normal code.
 - (5) Remove the SST from the terminals of DLC3.
SST 09843-18040

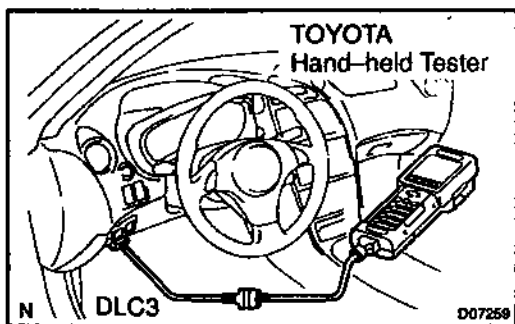

- (f) In case of using TOYOTA hand-held tester:
Clear the DTC.
- (1) Hook up the TOYOTA hand-held tester to the DLC3.
 - (2) Turn the ignition switch ON.
 - (3) Operate the TOYOTA hand-held tester to erase the codes. (See hand-held tester operator's manual.)

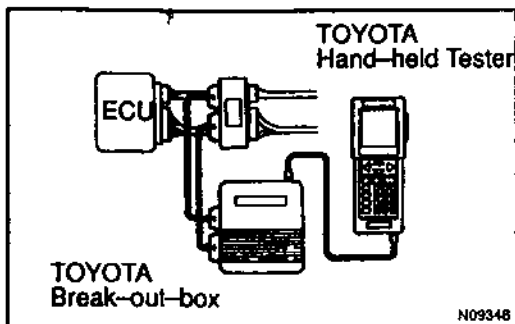

- (g) Reference:
Using TOYOTA break-out-box and TOYOTA hand-held tester, measure the ECU terminal values.
- (1) Hook up the TOYOTA hand-held tester and TOYOTA break-out-box to the vehicle.
 - (2) Read the ECU input/output values by following the prompts on the tester screen.

HINT:

TOYOTA hand-held tester has a "Snapshot" function. This records the measured values and is effective in the diagnosis of intermittent problems.

Please refer to the TOYOTA hand-held tester/TOYOTA break-out-box operator's manual for further details.

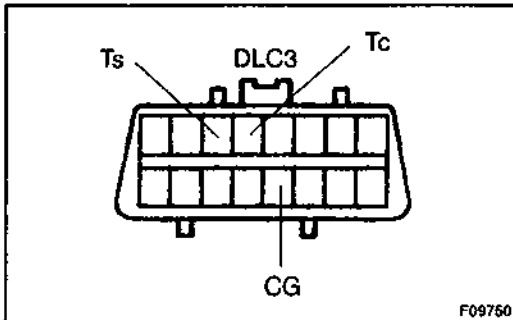
**2. SPEED SENSOR SIGNAL**

(a) In case of not using TOYOTA hand-held tester:

Check the speed sensor signal.

- (1) Turn the ignition switch OFF.
- (2) Using SST, connect terminals Ts and CG of DLC3.
SST 09843-18040
- (3) Start the engine.

- (4) Check that the ABS warning light blinks.

HINT:

If the ABS warning light does not blink, inspect the ABS warning light circuit (See page DI-314).

- (5) Drive vehicle straight forward.

HINT:

Drive vehicle faster than 45 km/h (28 mph) for several seconds.

- (6) Stop the vehicle.
- (7) Using SST, connect terminals Tc and CG of DLC3.
SST 09843-18040
- (8) Read the number of blinks of the ABS warning light.

HINT:

- See the list of DTC shown on the next page.
- If every sensor is normal, a normal code is output (A cycle of 0.25 sec. ON and 0.25 sec. OFF is repeated).
- If 2 or more malfunctions are indicated at the same time, the lowest numbered code will be displayed 1st.

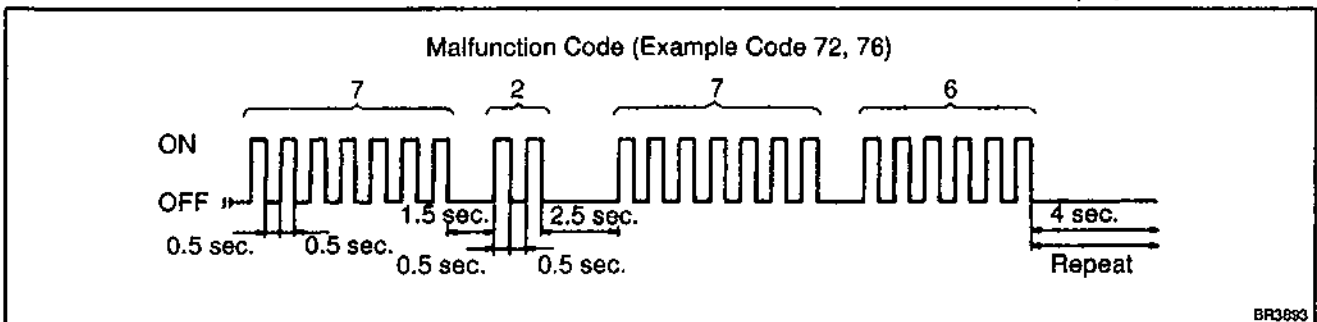
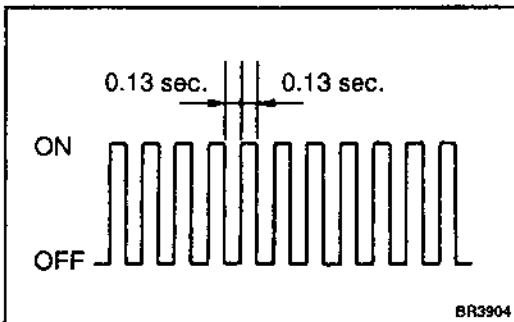

- (9) After doing the check, disconnect the SST from terminals Ts and CG, Tc and CG of DLC3, and turn ignition switch OFF.

SST 09843-18040

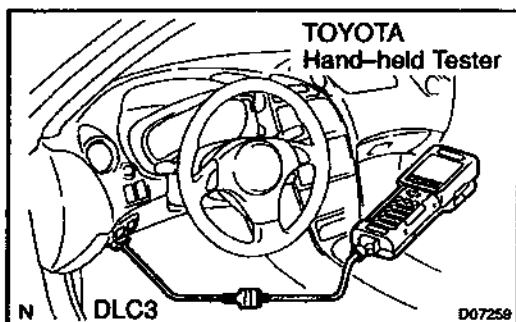

- (b) Using TOYOTA hand-held tester:
Check the DTC.

- (1) Hook up the TOYOTA hand-held tester to the DLC3.
- (2) Do step (3) to (6) on the previous page and this page.
- (3) Read the DTC by following the prompts on the tester screen.

Please refer to the TOYOTA hand-held tester operator's manual for further details.

DTC of speed sensor check function:

Code No.	Diagnosis	Trouble Area
C1271/71	Low output voltage of right front speed sensor	<ul style="list-style-type: none"> • Right front speed sensor • Sensor installation • Right front speed sensor rotor
C1272/72	Low output voltage of left front speed sensor	<ul style="list-style-type: none"> • Left front speed sensor • Sensor installation • Left front speed sensor rotor
C1273/73	Low output voltage of right rear speed sensor	<ul style="list-style-type: none"> • Right rear speed sensor • Sensor installation • Right rear speed sensor rotor
C1274/74	Low output voltage of left rear speed sensor	<ul style="list-style-type: none"> • Left rear speed sensor • Sensor installation • Left rear speed sensor rotor
C1275/75	Abnormal change in output voltage of right front speed sensor	Right front speed sensor rotor
C1276/76	Abnormal change in output voltage of left front speed sensor	Left front speed sensor rotor
C1277/77	Abnormal change in output voltage of right rear speed sensor	Right rear speed sensor rotor
C1278/78	Abnormal change in output voltage of left rear speed sensor	Left rear speed sensor rotor

DIAGNOSTIC TROUBLE CODE CHART**HINT:**

- Using SST 09843-18040, connect the terminals Tc and CG of the DLC3.
- If any abnormality is not found when inspection parts, inspect the ECU.
- If a malfunction code is displayed during the DTC check, check the circuit listed for the code. For details of each code, turn to the page referred to under the "See page" for respective "DTC No." in the DTC chart.

DTC No. (See Page)	Detection Item	Trouble Area
C0278/11 (DI-300)	Open circuit in ABS solenoid relay circuit	<ul style="list-style-type: none"> • ABS solenoid relay • ABS solenoid relay circuit
C0278/12 (DI-300)	Short circuit in ABS solenoid relay circuit	
C0273/13 (DI-295)	Open circuit in ABS motor relay circuit	<ul style="list-style-type: none"> • ABS motor relay • ABS motor relay circuit
C0274/14 (DI-295)	Short circuit in ABS motor relay circuit	
C0226/21 (DI-292)	Open or short circuit in 2-position solenoid circuit for right front wheel	<ul style="list-style-type: none"> • ABS actuator • SFRR or SFRH circuit
C0236/22 (DI-292)	Open or short circuit in 2-position solenoid circuit for left front wheel	<ul style="list-style-type: none"> • ABS actuator • SFLR or SFLH circuit
C0246/23 (DI-292)	Open or short circuit in 2-position solenoid circuit for right rear wheel	<ul style="list-style-type: none"> • ABS actuator • SRRR or SRRH circuit
C0256/24 (DI-292)	Open or short circuit in 2-position solenoid circuit for left rear wheel	<ul style="list-style-type: none"> • ABS actuator • SRLR or SRLH circuit
C0200/31 (DI-285)	Right front wheel speed sensor signal malfunction	<ul style="list-style-type: none"> • Right front, left front, right rear and left rear speed sensor • Each speed sensor circuit • Speed sensor rotor
C0205/32 (DI-285)	Left front wheel speed sensor signal malfunction	
C0210/33 (DI-285)	Right rear wheel speed sensor signal malfunction	
C0215/34 (DI-285)	Left rear wheel speed sensor signal malfunction	
C1235/35 (DI-285)	Right front wheel speed sensor have the sensor tips	<ul style="list-style-type: none"> • Right front, left front, right rear and left rear speed sensor • Each speed sensor circuit • Speed sensor rotor
C1236/36 (DI-285)	Left front wheel speed sensor have the sensor tips	
C1238/38 (DI-285)	Right rear wheel speed sensor have the sensor tips	
C1239/39 (DI-285)	Left rear wheel speed sensor have the sensor tips	
C1241/41 (DI-305)	Power source voltage down	<ul style="list-style-type: none"> • Battery • Charging system • Power source circuit
C1249/49 (DI-308)	Open circuit in stop light switch circuit	<ul style="list-style-type: none"> • Stop light switch • Stop light switch circuit • Stop light valve
C1251/51 (DI-310)	Pump motor is locked	<ul style="list-style-type: none"> • ABS pump motor
Always ON (DI-312)	Malfunction in ECU	<ul style="list-style-type: none"> • ECU • Battery

PARTS LOCATION

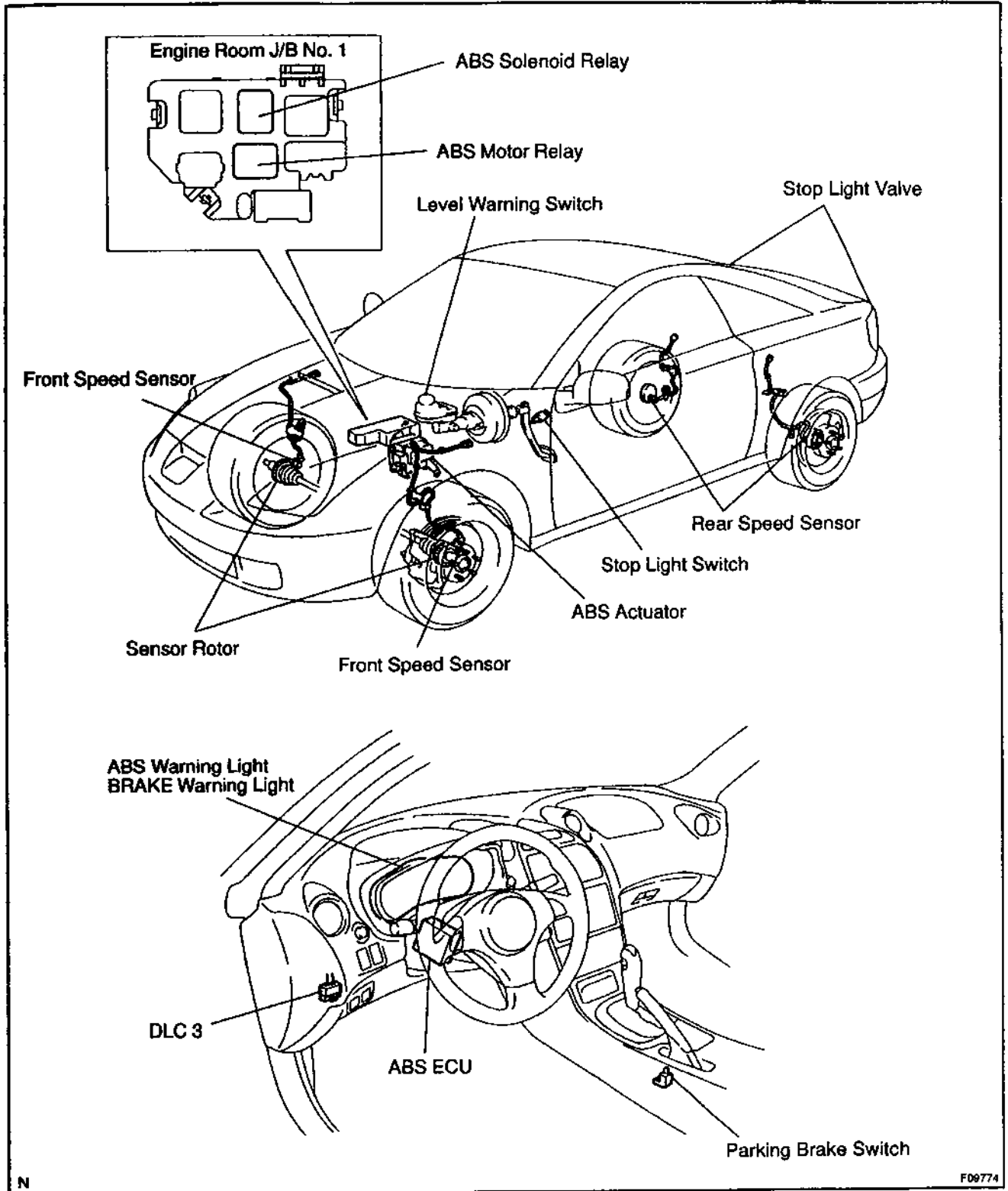

TERMINALS OF ECU

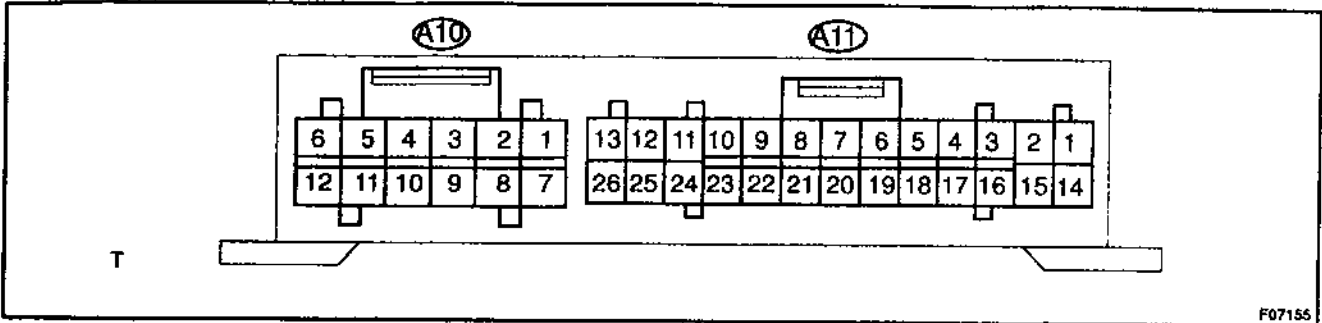

Symbols (Terminals No.)	Wiring Color	Condition	STD Voltage (V)
IG1 (A11 - 13) - GND (A11 - 12, 25)	B-Y ↔ W-B	IG switch ON	10 - 14
R+ (A11 - 26) - SR (A10 - 7)	GR-R ↔ GR	IG switch ON, ABS warning light OFF	9 - 14
R+ (A11 - 26) - MR (A10 - 1)	GR-R ↔ R-Y	IG switch ON	Below 1.0
SFRR (A11 - 1) - GND (A11 - 12, 25)	LG-B ↔ W-B	IG switch ON, ABS warning light OFF	10 - 14
SFRH (A11 - 2) - GND (A11 - 12, 25)	LG ↔ W-B	IG switch ON, ABS warning light OFF	10 - 14
SFLR (A10 - 6) - GND (A11 - 12, 25)	R-W ↔ W-B	IG switch ON, ABS warning light OFF	10 - 14
SFLH (A10 - 5) - GND (A11 - 12, 25)	LG-R ↔ W-B	IG switch ON, ABS warning light OFF	10 - 14
SRRR (A10 - 12) - GND (A11 - 12, 25)	Y-R ↔ W-B	IG switch ON, ABS warning light OFF	10 - 14
SRRH (A10 - 11) - GND (A11 - 12, 25)	Y-G ↔ W-B	IG switch ON, ABS warning light OFF	10 - 14
SRLR (A11 - 14) - GND (A11 - 12, 25)	B-R ↔ W-B	IG switch ON, ABS warning light OFF	10 - 14
SRLH (A11 - 15) - GND (A11 - 12, 25)	GR-L ↔ W-B	IG switch ON, ABS warning light OFF	10 - 14
WA (A11 - 11) - GND (A11 - 12, 25)	V ↔ W-B	IG switch ON, ABS warning light ON	10 - 14
		IG switch ON, ABS warning light OFF	Below 2.0
STP (A11 - 5) - GND (A11 - 12, 25)	G-W ↔ W-B	Stop light switch OFF	Below 1.5
		Stop light switch ON	8 - 14
D/G (A11 - 24) - GND (A11 - 12, 25)	W ↔ W-B	IG switch ON, ABS warning light OFF	10 - 14
Tc (A11 - 8) - GND (A11 - 12, 25)	P-B ↔ W-B	IG switch ON	8 - 14
Ts (A11 - 21) - GND (A11 - 12, 25)	W-R ↔ W-B	IG switch ON	8 - 14
FR+ (A10 - 3) - FR- (A10 - 9)	P ↔ L	IG switch ON, slowly turn right front wheel	AC generation
FL+ (A10 - 8) - FL- (A10 - 2)	Y ↔ BR	IG switch ON, slowly turn left front wheel	AC generation
RR+ (A11 - 10) - RR- (A11 - 23)	W ↔ B	IG switch ON, slowly turn right rear wheel	AC generation
RL+ (A11 - 22) - RL- (A11 - 9)	R ↔ G	IG switch ON, slowly turn left rear wheel	AC generation

MT (A10 - 10) - GND (A11 - 12, 25)	LG-B ↔ W-B	IG switch ON	Below 1.5
PKB (A11 - 6) - GND (A11 - 21, 25)	R-B ↔ W-B	IG switch ON, parking brake switch ON	Below 2.0
		IG switch ON, parking brake switch OFF	10 - 14
BRL (A11 - 18) - GND (A11 - 21, 25)	GR ↔ W-B	IG switch ON, BRAKE indicator light ON	10 - 14
		IG switch ON, BRAKE indicator light OFF	Below 2.0

PROBLEM SYMPTOMS TABLE

If a normal code is displayed during the DTC check but the problem still occurs, check the circuits for each problem symptom in the order given in the table below and proceed to the relevant troubleshooting page.

NOTICE:

When replacing ABS ECU, sensor or etc., turn the IG switch OFF.

Symptom	Suspect Area	See page
ABS does not operate	<p>Only when 1. to 4. are all normal and the problem is still occurring, replace the ABS ECU.</p> <ol style="list-style-type: none"> 1. Check the DTC reconfirming that the normal code is output. 2. IG power source circuit 3. Speed sensor circuit 4. Check the ABS actuator with a checker or TOYOTA hand-held tester. <p>If abnormal, check the hydraulic circuit for leakage (See page DI-323).</p>	<p>DI-276</p> <p>DI-305</p> <p>DI-285</p> <p>BR-48</p>
ABS does not operate efficiently	<p>Only when 1. to 4. are all normal and the problem is still occurring, replace the ABS ECU.</p> <ol style="list-style-type: none"> 1. Check the DTC reconfirming that the normal code is output. 2. Speed sensor circuit 3. Stop light switch circuit 4. Check the ABS actuator with a checker or TOYOTA hand-held tester. <p>If abnormal, check the hydraulic circuit for leakage (See page DI-323).</p>	<p>DI-276</p> <p>DI-285</p> <p>DI-308</p> <p>BR-48</p>
ABS warning light abnormal	<ol style="list-style-type: none"> 1. ABS warning light circuit 2. ABS ECU 	DI-314
BRAKE warning light abnormal	<ol style="list-style-type: none"> 1. BRAKE warning light circuit 2. ABS ECU 	DI-317
DTC check cannot be done	<p>Only when 1. and 2. are all normal and the problem is still occurring, replace the ABS ECU.</p> <ol style="list-style-type: none"> 1. ABS warning light circuit 2. Tc terminal circuit 	<p>DI-314</p> <p>DI-319</p>
Speed sensor signal check cannot be done	<ol style="list-style-type: none"> 1. Ts terminal circuit 2. ABS ECU 	DI-321

CIRCUIT INSPECTION

DM9E-01

DTC	C0200/31 - C1239/39	Speed Sensor Circuit
------------	----------------------------	-----------------------------

CIRCUIT DESCRIPTION

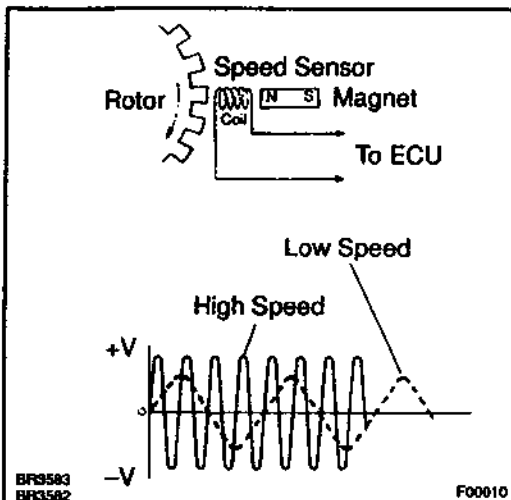

The speed sensor detects wheel speed and sends the appropriate signals to the ECU. These signals are used to control the ABS system. The front and rear rotors each have 48 serrations.

When the rotors rotate, the magnetic field emitted by the permanent magnet in the speed sensor generates an AC voltage. Since the frequency of this AC voltage changes in direct proportion to the speed of the rotor, the frequency is used by the ECU to detect the speed of each wheel.

DTC No.	DTC Detecting Condition	Trouble Area
C0200/31 C0205/32 C0210/33 C0215/34	Detection of any of conditions from 1. through 3.: 1. Vehicle speed is at 10 km/h (6 mph) or more and the speed sensor signal circuit is open or short circuit continues for 15 sec. or more. 2. Momentary interruption of the speed sensor signal occurs 7 times or more. 3. Open circuit condition of the speed sensor signal circuit continues for 0.5 sec. or more.	<ul style="list-style-type: none"> • Right front, left front, right rear, left rear speed sensor • Each speed sensor circuit • Speed sensor rotor
C1235/35 C1236/36 C1238/38 C1239/39	Vehicle speed is at 20 km/h (12mph) or more and interference on the speed sensor signal continues for 5 sec. or more.	<ul style="list-style-type: none"> • Right front, left front, right rear, left rear speed sensor • Speed sensor rotor
C0210/33 C0215/34	The condition that the both rear side wheels' speed is lower than the front wheels' speed at 20 km/h (12 mph) or more for 20 sec. or more when the IG switch turns ON and OFF, which is repeated in a sequence more than 8 times.	<ul style="list-style-type: none"> • Rear axle hub • Right rear, left rear speed sensor • Rear speed sensor circuit

HINT:

- DTC No. C0200/31 and C1235/35 is for the right front speed sensor.
- DTC No. C0205/32 and C1236/36 is for the left front speed sensor.
- DTC No. C0210/33 and C1238/38 is for the right rear speed sensor.

WIRING DIAGRAM

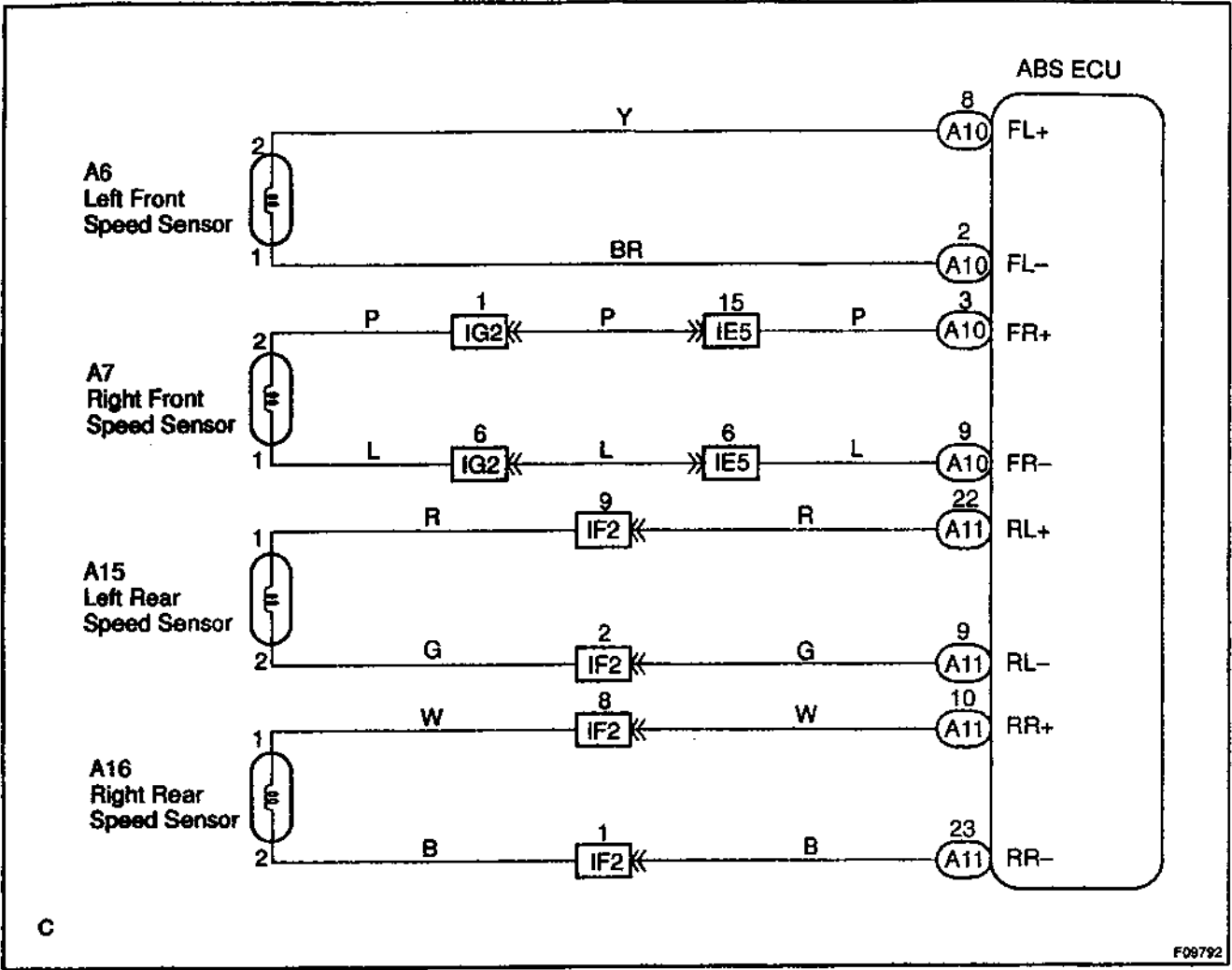

INSPECTION PROCEDURE

HINT:

Start the inspection from step 1 in case of using the TOYOTA hand-held tester and start from step 2 in case of not using the TOYOTA hand-held tester.

1	Check output value of speed sensor.
----------	--------------------------------------------

PREPARATION:

- (a) Connect the TOYOTA hand-held tester to the DLC3.
- (b) Turn the ignition switch ON and push the TOYOTA hand-held tester main switch ON.
- (c) Select the DATALIST mode on the TOYOTA hand-held tester.

CHECK:

Check that there is no difference between the speed value output from the speed sensor displayed on the TOYOTA hand-held tester and the speed value displayed on the speedometer when driving the vehicle.

OK:

There is almost no difference from the displayed speed value.

HINT:

There is tolerance of $\pm 10\%$ in the speedometer indication.

OK	Check and replace ABS ECU.
-----------	-----------------------------------

NG

2	Check speed sensor.
----------	----------------------------

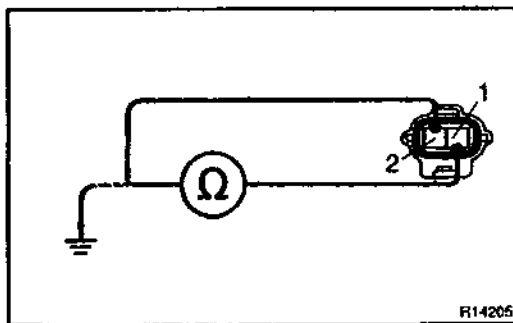

Front:

PREPARATION:

- (a) Remove the front fender liner.
- (b) Make sure that there is no looseness at the connector lock part and connecting part of the connector.
- (c) Disconnect the speed sensor connector.

CHECK:

Measure resistance between terminals 1 and 2 of speed sensor connector.

OK:

Resistance: 1.4 – 1.8 k Ω at 20 °C

CHECK:

Measure resistance between terminals 1 and 2 of speed sensor connector and body ground.

OK:

Resistance: 10 M Ω or higher

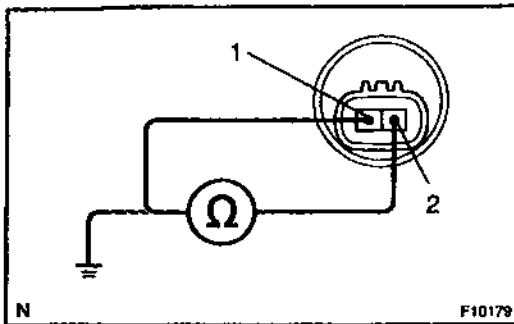
**Rear speed sensor:****PREPARATION:**

- Make sure that there is no looseness at the connector lock part and connecting part of the connector.
- Disconnect the speed sensor connector at hub bearing .

CHECK:

Measure resistance between terminals 1 and 2 of speed sensor connector.

OK:

Resistance: 0.9 – 1.3 kΩ at 25 ± 5 °C

CHECK:

Measure resistance between terminals 1 and 2 of speed sensor connector and body ground.

OK:

Resistance: 1 MΩ or higher

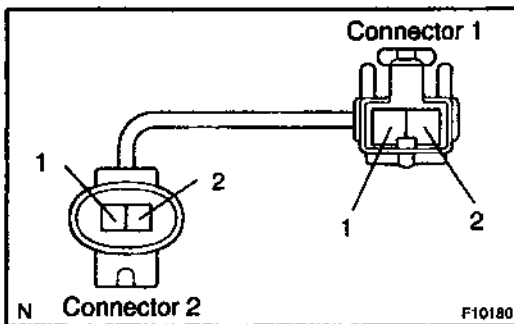
**Rear speed sensor sub-wire harness:****PREPARATION:**

- Remove the seat cushion and seatback.
- Make sure that there is no looseness at the connector lock part and connecting part of the connector.
- Disconnect the speed sensor connector inside vehicle.

CHECK:

- Measure resistance between terminal 1 of connector 1 and terminal 2 of connector 2.
- Measure resistance between terminal 2 of connector 1 and terminal 1 of connector 2.

OK:

Resistance: below 1 Ω

CHECK:

Measure resistance between terminals 1 and 2 of speed sensor connector 1 and body ground.

OK:

Resistance: 10 MΩ or higher

NG

Replace speed sensor or sub-wire harness.

NOTICE:

Check the speed sensor signal last (See page DI-276).

OK

3 Check for open and short circuit in harness and connector between each speed sensor and ABS ECU (See page IN-30).

NG Repair or replace harness or connector.

OK

4 Check speed sensor installation.

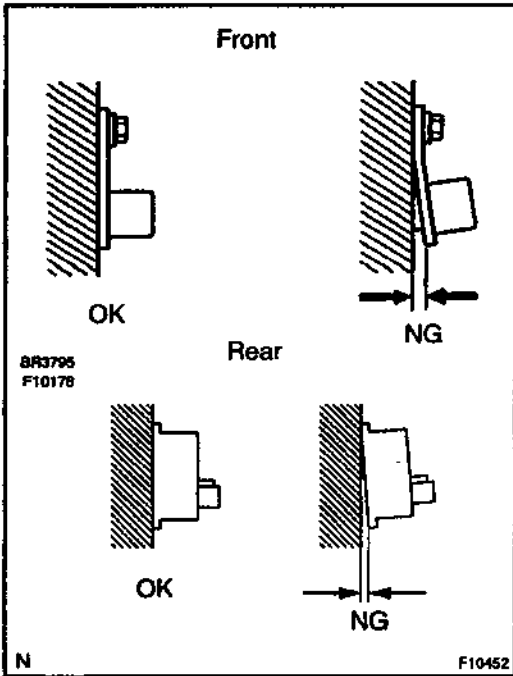

CHECK:

Check the speed sensor installation.

OK:

The installation bolt is tightened properly and there is no clearance between the sensor and steering knuckle or rear axle carrier.

NG Replace speed sensor.

NOTICE:

Check the speed sensor signal last (See page DI-276).

OK

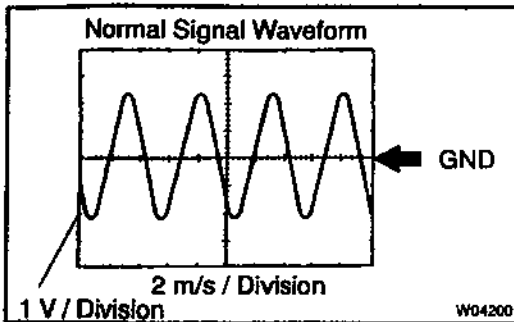
5 Check speed sensor and sensor rotor serrations.**REFERENCE: INSPECTION USING OSCILLOSCOPE****PREPARATION:**

- Remove the ABS ECU with connectors still connected.
- Connect the oscilloscope to the terminals FR+, FL+, RR+ or RL+ and GND of the ABS ECU.

CHECK:

Drive the vehicle with about 30 km/h (19 mph), and check the signal waveform.

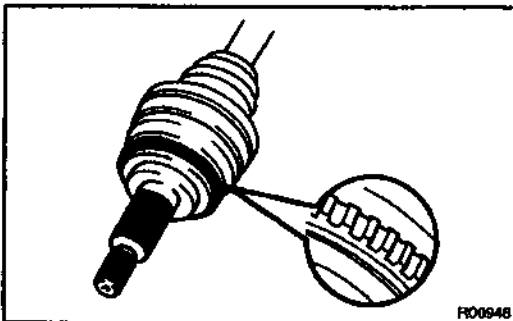
OK**Check and replace ABS ECU.****NG****6 Check sensor rotor and sensor tip.****Front:****PREPARATION:**

Remove the front drive shaft (See page SA-20).

CHECK:

Check the sensor rotor serrations.

OK:

No scratches or missing teeth or foreign objects.

PREPARATION:

Remove the front speed sensor (See page BR-56).

CHECK:

Check the sensor tip.

OK:

No scratches or foreign objects on the sensor tip.

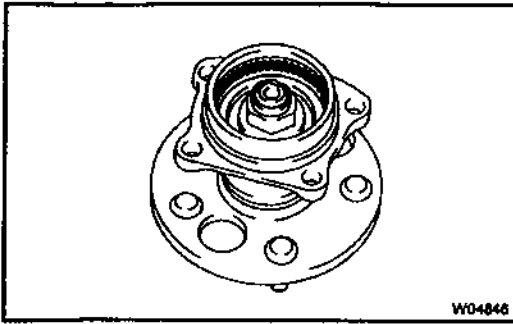

Rear:

PREPARATION:

Remove the rear speed sensor (See page BR-59).

CHECK:

Check the sensor rotor serrations.

OK:

No scratches or missing teeth or foreign objects.

CHECK:

Check the sensor tip.

OK:

No scratches or foreign objects on the sensor tip.



Replace sensor rotor or speed sensor.

NOTICE:

Check the speed sensor signal last (See page DI-276).



Check and replace ABS ECU.

DTC	C0226/21 - C0256/24	ABS Actuator Solenoid Circuit
------------	----------------------------	--------------------------------------

CIRCUIT DESCRIPTION

This solenoid goes on when signals are received from the ECU and controls the pressure acting on the wheel cylinders thus controlling the braking force.

DTC No.	DTC Detecting Condition	Trouble Area
C0226/21	Condition 1. or 2. continues for 0.05 sec. or more: 1. IG1 terminal voltage of ABS ECU is 9.5 - 18.5 V, there is open or short circuit in actuator solenoid SFRH or SFRH. 2. IG1 terminal voltage of ABS ECU is 9.5 - 18.5 V, and while ABS is control in operation.*1	<ul style="list-style-type: none"> • ABS actuator • SFRH or SFRH circuit
C0236/22	Condition 1. or 2. continues for 0.05 sec. or more: 1. IG1 terminal voltage of ABS ECU is 9.5 - 18.5 V, there is open or short circuit in actuator solenoid SFLR or SFLH. 2. IG1 terminal voltage of ABS ECU is 9.5 - 18.5 V, and while ABS is control in operation.*1	<ul style="list-style-type: none"> • ABS actuator • SFLR or SFLH circuit
C0246/23	Condition 1. or 2. continues for 0.05 sec. or more: 1. IG1 terminal voltage of ABS ECU is 9.5 - 18.5 V, there is open or short circuit in actuator solenoid SRRR or SRRH. 2. IG1 terminal voltage of ABS ECU is 9.5 - 18.5 V, and while ABS is control in operation.*1	<ul style="list-style-type: none"> • ABS actuator • SRRR or SRRH circuit
C0256/24	Condition 1. or 2. continues for 0.05 sec. or more: 1. IG1 terminal voltage of ABS ECU is 9.5 - 18.5 V, there is open or short circuit in actuator solenoid SRLR or SRLH. 2. IG1 terminal voltage of ABS ECU is 9.5 - 18.5 V, and while ABS is control in operation.*1	<ul style="list-style-type: none"> • ABS actuator • SRLR or SRLH circuit

*1 Solenoid relay contact ON condition:

All of solenoid terminal voltage is half of IG1 terminal voltage or less than.

WIRING DIAGRAM

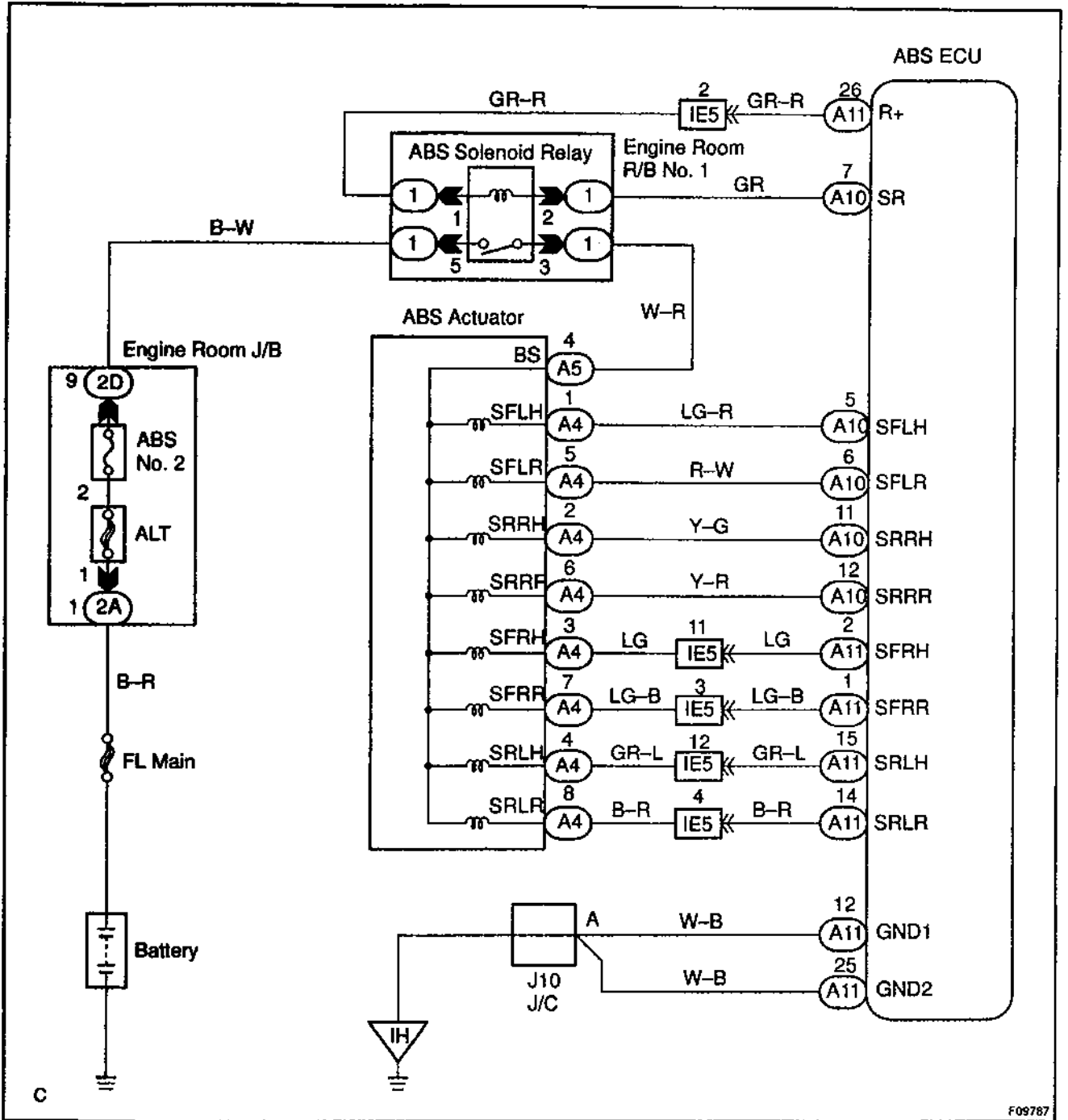

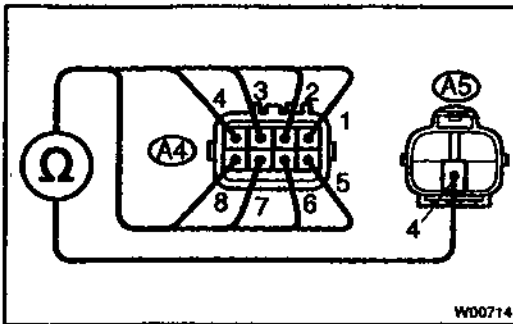
INSPECTION PROCEDURE**1 Check ABS actuator solenoid.****PREPARATION:**

Disconnect the 2 connectors from ABS actuator.

CHECK:

Check continuity between terminals A5 - 4 and A4 - 1, 2, 3, 4, 5, 6, 7, 8 of ABS actuator connector.

OK:

Continuity

HINT:

Resistance of S##H solenoid coil is approx. 8 Ω.

Resistance of S##R solenoid coil is approx. 4 Ω.

NG**Replace ABS actuator.****OK****2 Check for open and short circuit in harness and connector between ABS ECU and actuator (See page IN-30).****NG****Repair or replace harness or connector.****OK**

If the same code is still output after the DTC is deleted, check the contact condition of each connection. If the connections are normal, the ECU may be defective.

06A4-01

DTC	C0273/13, C0274/14	ABS Motor Relay Circuit
------------	---------------------------	--------------------------------

CIRCUIT DESCRIPTION

The ABS motor relay supplies power to the ABS pump motor. While the ABS is activated, the ECU switches the ABS motor relay ON and operates the ABS pump motor.

DTC No.	DTC Detecting Condition	Trouble Area
C0273/13	Condition 1. or 2. continues for 0.2 sec. or more: 1. ABS ECU terminal IG1 voltage is 9.5 V to 18.5 V, and when motor relay is ON in the midst of initial check or in operation of ABS control.*1 2. Motor relay is ON driving in the midst of initial check or in operation of ABS control, ABS ECU terminal IG1 voltage becomes 9.5 V or less.*2	• ABS motor relay • ABS motor relay circuit
C0274/14	Condition below continues for 4 sec. or more: When the motor relay is OFF, there is open circuit in MT terminal of ABS ECU.	

*1 Relay contact OFF condition: MT terminal voltage is below 3.6 V.

*2 Relay contact ON condition: MT terminal voltage is 3.6 V or above.

WIRING DIAGRAM

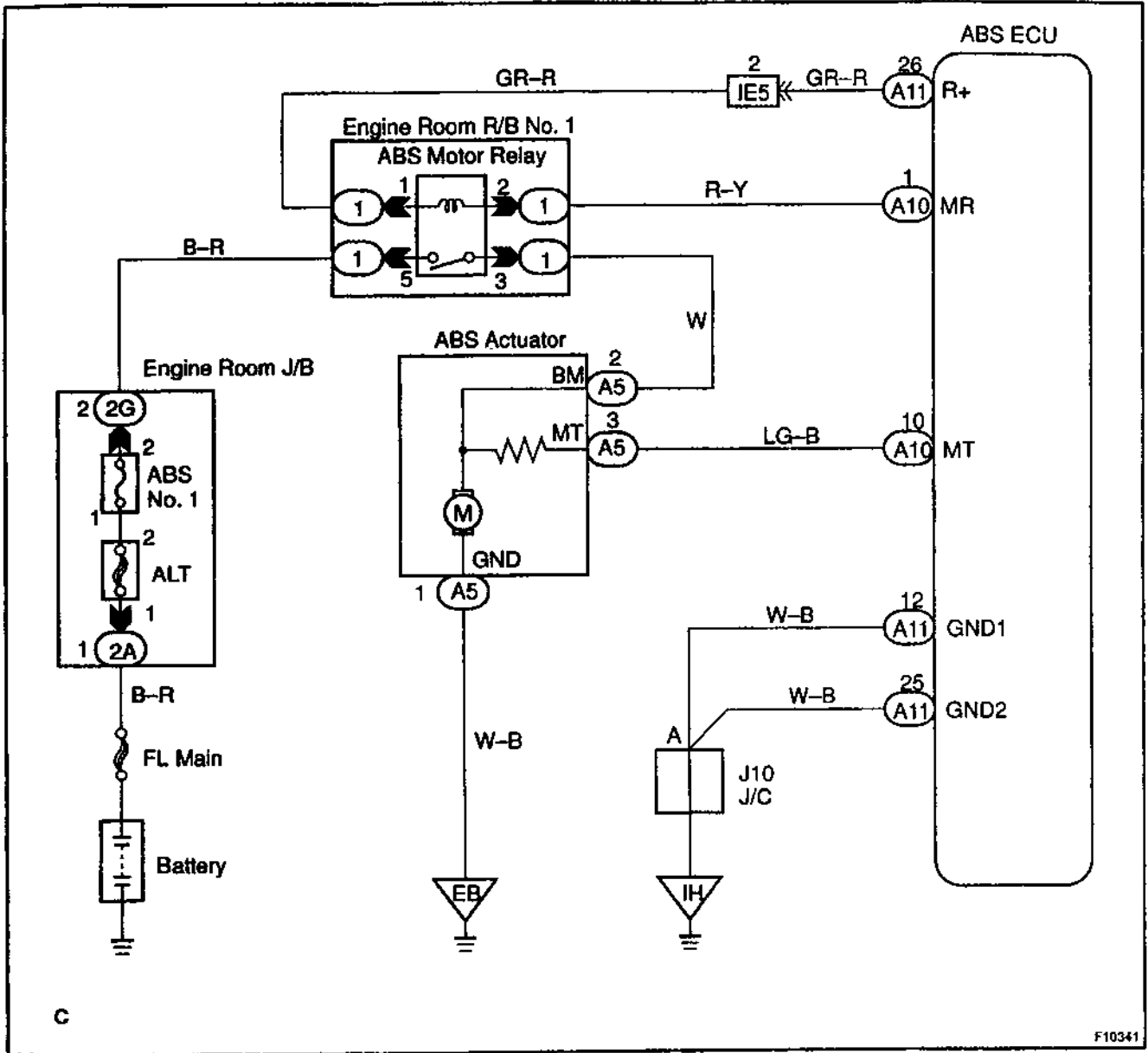

INSPECTION PROCEDURE

HINT:

Start the inspection from step 1 in case of using the TOYOTA hand-held tester and start from step 2 in case of not using TOYOTA hand-held tester.

1	Check ABS motor relay operation.
----------	-----------------------------------------

PREPARATION:

- (a) Connect the TOYOTA hand-held tester to the DLC3.
- (b) Turn the ignition switch ON and push the TOYOTA hand-held tester main switch ON.
- (c) Select the ACTIVE TEST mode on the TOYOTA hand-held tester.

CHECK:

Check the operation sound of the ABS motor relay when operating it with the TOYOTA hand-held tester.

OK:

The operation sound of the ABS motor relay should be heard.

OK	Go to step 5.
-----------	----------------------

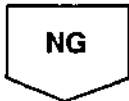

2	Check voltage between terminal 5 of engine room R/B No. 1 (for ABS motor relay) and body ground.
----------	---------------------------------------------------------------------------------------------------------

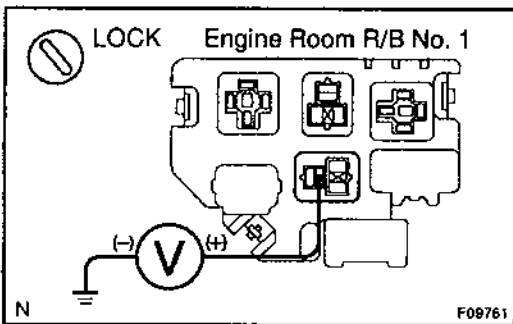

PREPARATION:

Remove the ABS motor relay from engine room R/B No. 1.

CHECK:

Measure voltage between terminal 5 of engine room R/B No. 1 (for ABS motor relay) and body ground.

OK:

Voltage: 10 – 14 V

NG	Check and repair harness or connector.
-----------	-----------------------------------------------

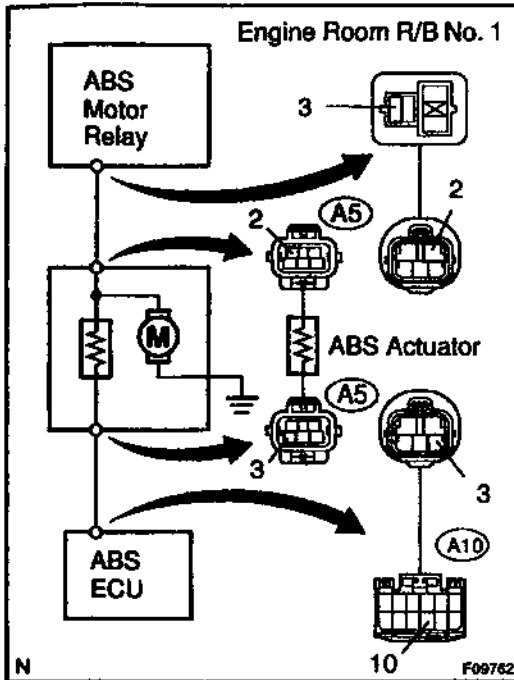

3 Check continuity between terminal 3 of ABS motor relay and terminal MT (A10 - 10) of ABS ECU.

**CHECK:**

Check continuity between terminal 3 of engine room R/B No.1 (for ABS motor relay) and terminal MT (A10 - 10) of ABS ECU.

OK:**Continuity****HINT:**

There is a resistance of 4 - 6 Ω between terminals A5 - 2 and A5 - 3 of ABS actuator.

NG**Repair or replace harness or ABS actuator.****OK**

4 Check ABS motor relay.

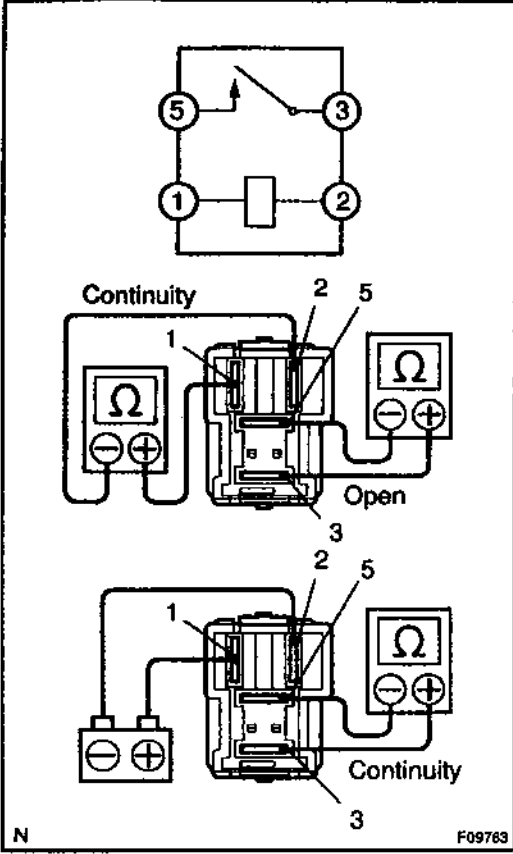

CHECK:
Check continuity between each terminal of ABS motor relay.

OK:

Terminals 1 and 2	Continuity (Reference value 62 Ω)
Terminals 3 and 5	Open

CHECK:
(a) Apply battery positive voltage between terminals 1 and 2.
(b) Check continuity between terminals of ABS motor relay.

OK:

Terminals 3 and 5	Continuity
-------------------	------------

NG Replace ABS motor relay.

OK

5 Check for open and short circuit in harness and connector between ABS motor relay and ABS ECU (See page IN-30).

NG Repair or replace harness or connector.

OK

If the same code is still output after the DTC is deleted, check the contact condition of each connection. If the connections are normal, the ECU may be defective.

DTC	C0278/11, C0279/12	ABS Solenoid Relay Circuit
------------	---------------------------	-----------------------------------

CIRCUIT DESCRIPTION

This relay supplies power to each ABS solenoid. After the ignition switch is turned ON, if the initial check is OK, the relay goes on.

DTC No.	DTC Detecting Condition	Trouble Area
C0278/11	Condition 1. or 2. continues for 0.2 sec. or more: 1. IG1 terminal voltage of ABS ECU is 9.5 – 18.5 V, and when the solenoid relay is ON.* ¹ 2. With solenoid relay ON driving, when IG1 terminal of ABS ECU is less than 9.5 V.* ¹	<ul style="list-style-type: none"> • ABS solenoid relay • ABS solenoid relay circuit
C0279/12	Immediately after IG switch has been turned ON, when the solenoid relay is OFF.* ²	

*¹ Solenoid relay contact OFF condition:

All of solenoid terminal voltage is half of IG1 terminal voltage or less than.

*² Solenoid relay contact ON condition:

All of solenoid terminal voltage is half of IG 1 terminal voltage or more.

WIRING DIAGRAM

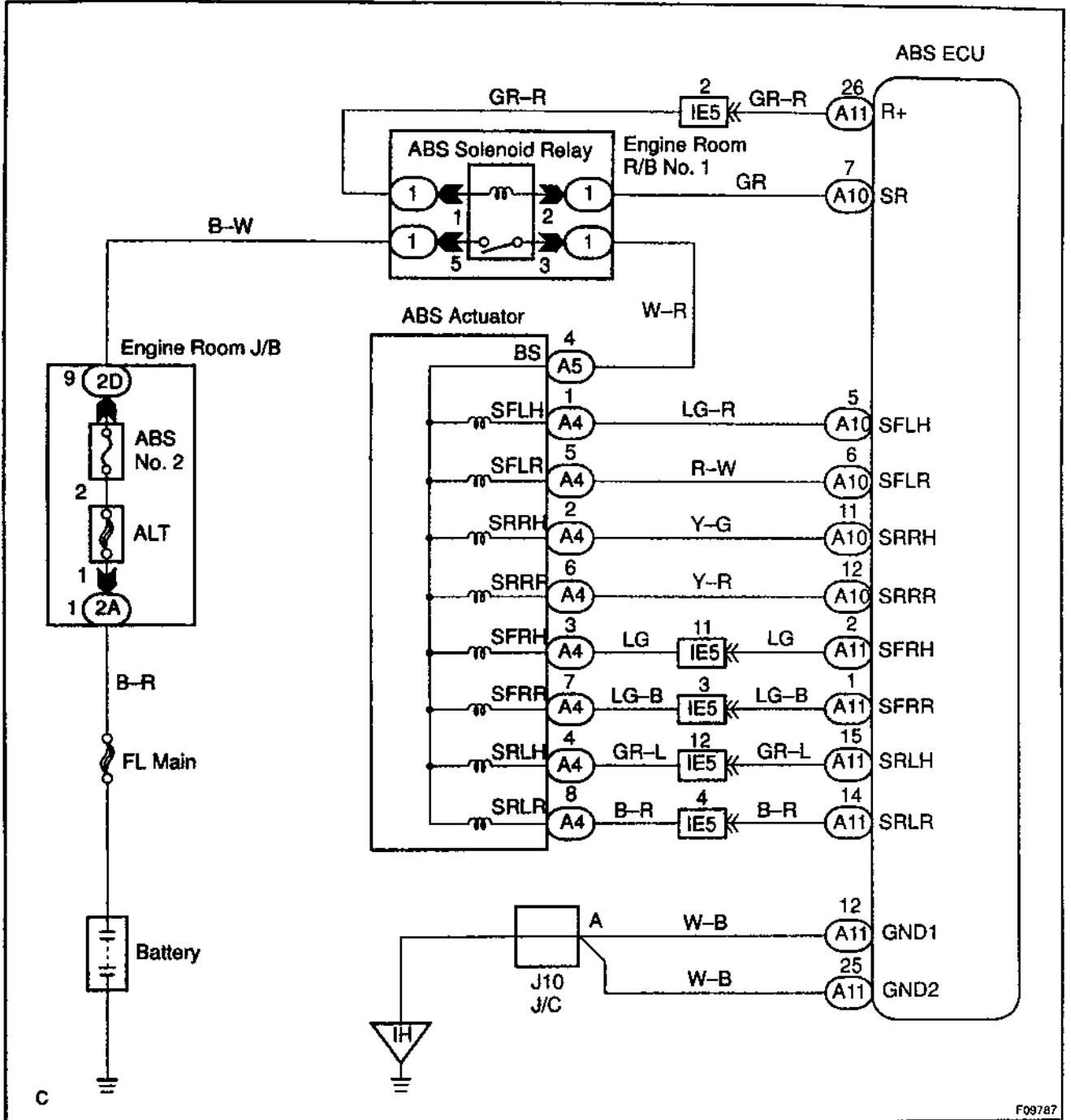

INSPECTION PROCEDURE**HINT:**

Start the inspection from step 1 in case of using the TOYOTA hand-held tester and start from step 2 in case of not using the TOYOTA hand-held tester.

1	Check ABS solenoid relay operation.
----------	--------------------------------------------

PREPARATION:

- (a) Connect the TOYOTA hand-held tester to the DLC3.
- (b) Turn the ignition switch ON and push the TOYOTA hand-held tester main switch ON.
- (c) Select the ACTIVE TEST mode on the TOYOTA hand-held tester.

CHECK:

Check the operation sound of the ABS solenoid relay when operating it with the TOYOTA hand-held tester.

OK:

The operation sound of the ABS solenoid relay should be heard.

OK	Go to step 5.
----	---------------

NG

2	Check voltage between terminal 5 of engine room R/B No. 1 (for ABS solenoid relay) and body ground.
----------	------------------------------------------------------------------------------------------------------------

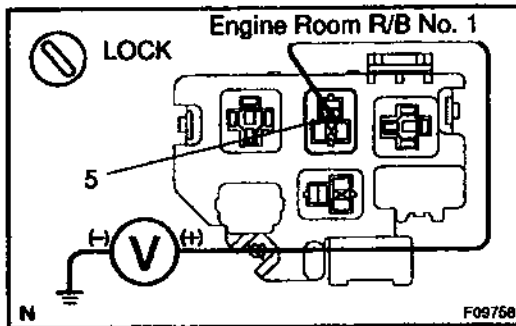
**PREPARATION:**

Remove the ABS solenoid relay from engine room R/B No. 1.

CHECK:

Measure the voltage between terminal 5 of engine room R/B No. 1 (for ABS solenoid relay) and body ground.

OK:

Voltage: 10 - 14 V

NG	Check and repair harness or connector.
----	----------------------------------------

OK

3 Check continuity between terminal 3 of engine room R/B No. 1 (for ABS solenoid relay) and each solenoid terminal of ABS ECU.

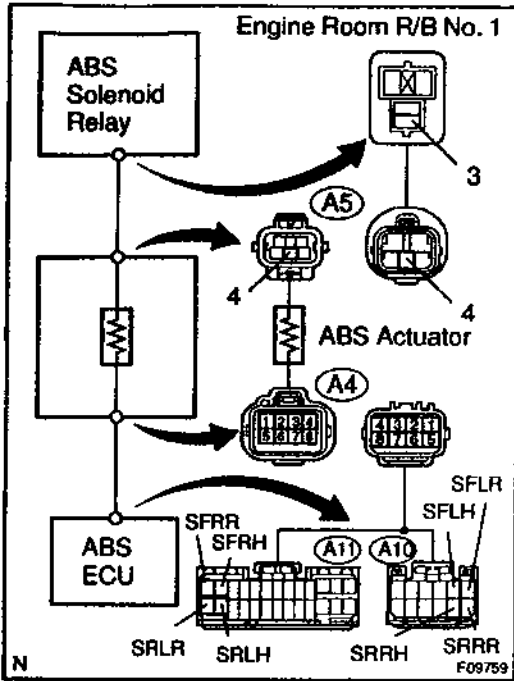

CHECK:

Check continuity between terminal 3 of engine room R/B No. 1 (for ABS solenoid relay) and terminal SRLR, SRLH, SRRR, SRRH, SFLR, SFLH, SFRR or SFRH of ABS ECU.

OK:

Continuity

HINT:

Resistance of each solenoid coil
 SRLR, SRRR, SFLR, SFRR: 4.3 Ω
 SRLH, SRRH, SFLH, SFRH: 8.8 Ω

NG Repair or replace harness or ABS actuator.

OK

4 Check ABS solenoid relay.

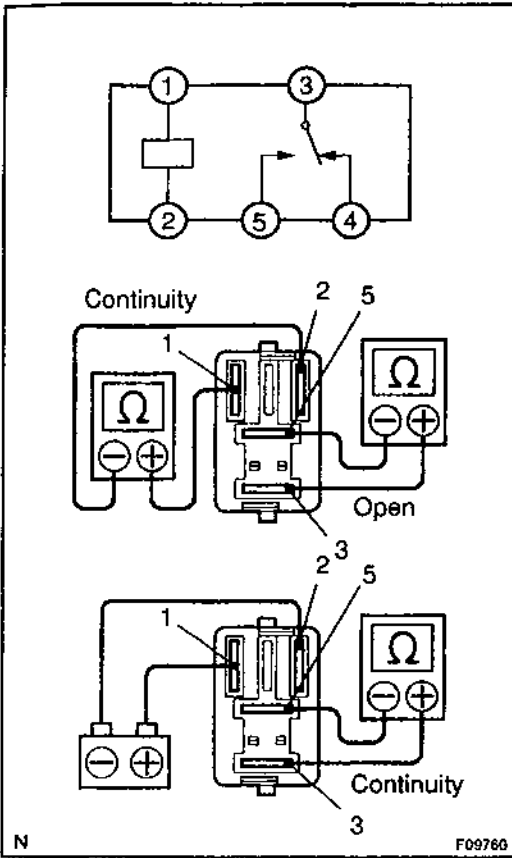

CHECK:

Check continuity between each terminal of ABS solenoid relay.

OK:

Terminals 1 and 2	Continuity (Reference value 100 Ω)
Terminals 3 and 5	Open

CHECK:

- (a) Apply battery positive voltage between terminals 1 and 2.
- (b) Check continuity between each terminal of ABS solenoid relay.

OK:

Terminals 3 and 5	Continuity
-------------------	------------

NG Replace ABS solenoid relay.

OK

5 Check for open and short circuit in harness and connector between ABS solenoid relay and ABS ECU (See page IN-30).

NG Repair or replace harness or connector.

OK

If the same code is still output after the DTC is deleted, check the contact condition of each connection. If the connections are normal, the ECU may be defective.

DTC	C1241/41	IG Power Source Circuit
------------	-----------------	--------------------------------

CIRCUIT DESCRIPTION

This is the power source for the ECU, hence the actuators.

DTC No.	DTC Detecting Condition	Trouble Area
C1241/41	Condition 1. or 2. is detected: 1. Vehicle speed is at 3 km/h (1.9 mph) or more and ECU terminal IG1 voltage is 9.5 V or less, which continues for 10 sec. or more. 2. When IG1 terminal voltage is less than 9.5 V, there is open circuit in the motor relay or in the solenoid relay, or the solenoid circuit malfunction.	<ul style="list-style-type: none"> • Battery • Charging system • Power source circuit

WIRING DIAGRAM

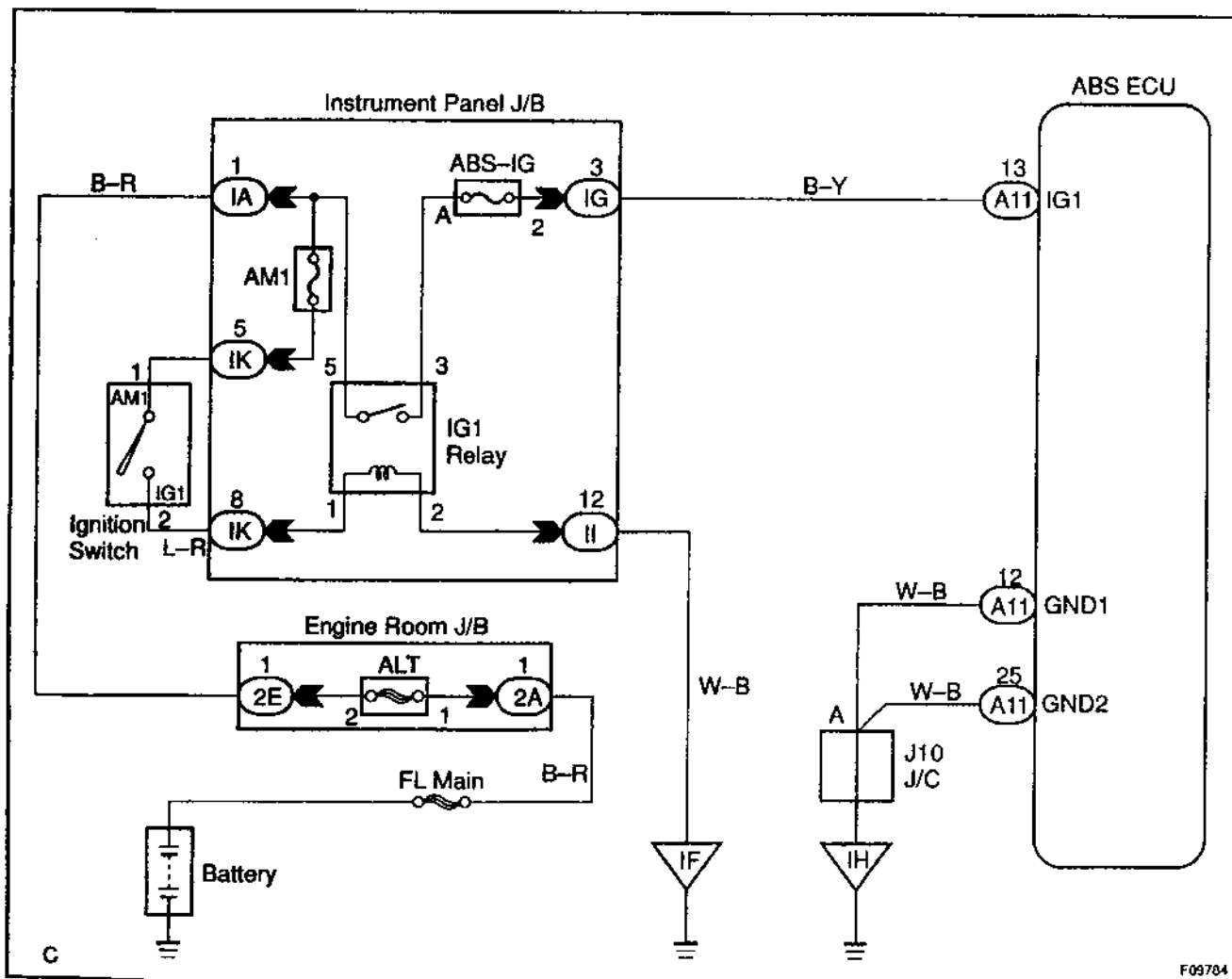

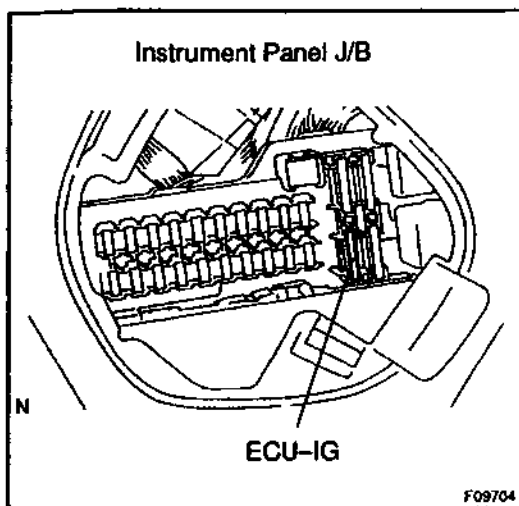
INSPECTION PROCEDURE**1 Check ECU-IG fuse.****PREPARATION:**

Remove ECU-IG fuse from Instrument Panel J/B.

CHECK:

Check continuity of ECU-IG fuse.

OK:

Continuity

NG

Check for short circuit in all the harness and components connected to ECU-IG fuse (See attached wiring diagram).

OK**2 Check battery positive voltage.****OK:**

Voltage: 10 - 14 V

NG

Check and repair the charging system. (See page CH-2)

OK

3 Check voltage of the ABS-IG power source.

In case of using TOYOTA hand-held tester:

PREPARATION:

- (a) Connect the TOYOTA hand-held tester to the DLC3.
- (b) Turn the ignition switch ON and push the TOYOTA hand-held tester main switch ON.
- (c) Select the DATALIST mode on the TOYOTA hand-held tester.

CHECK:

Check the voltage condition output from the ECU displayed on the TOYOTA hand-held tester.

OK:

"Normal" is displayed.

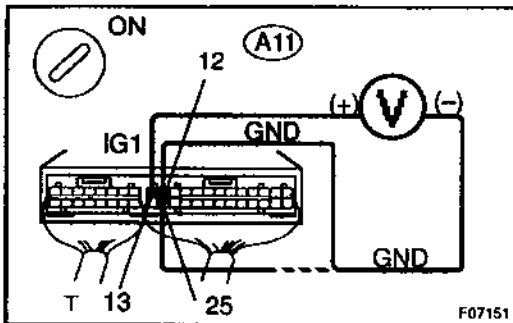

In case of not using TOYOTA hand-held tester:

PREPARATION:

Remove ABS ECU with connectors still connected.

CHECK:

- (a) Turn the ignition switch ON.
- (b) Measure voltage between terminals A11 - 13 and A11 - 12, 25 of ABS ECU connector.

OK:

Voltage: 10 - 14 V

OK

Check and replace ABS ECU.

NG

4 Check continuity between terminals GND (A11 - 12, 25) of ABS ECU connector and body ground.

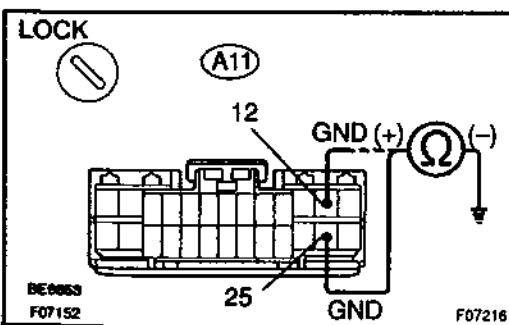

PREPARATION:

Disconnect the connector from the ABS ECU.

CHECK:

Measure resistance between terminal A11 - 12, 25 of ABS ECU harness side connector and body ground.

OK:

Resistance: 1 Ω or less

NG

Repair or replace harness or connector.

OK

Check for open circuit in harness and connector between ABS ECU and ECU-IG fuse (See page IN-30).

DTC	C1249/49	Stop Light Switch Circuit
------------	-----------------	----------------------------------

CIRCUIT DESCRIPTION

DTC No.	DTC Detecting Condition	Trouble Area
C1249/49	ABS ECU terminal IG1 voltage is 9.5 V to 18.5 V and ABS is in non-operation, the open circuit of the stop light switch circuit continues for 0.3 sec. or more.	<ul style="list-style-type: none"> • Stop light switch • Stop light switch circuit

WIRING DIAGRAM

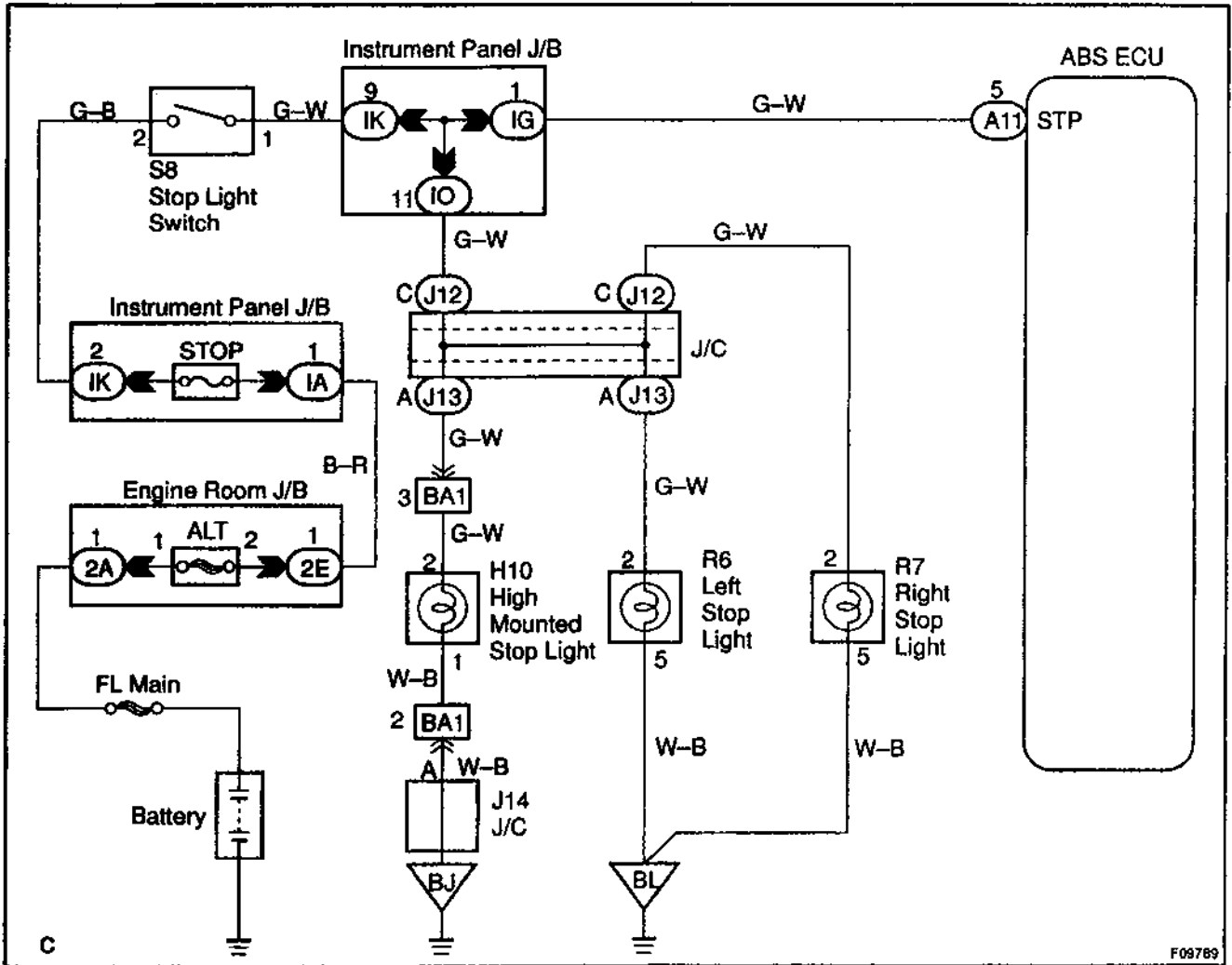

INSPECTION PROCEDURE

1 Check operation of stop light.

CHECK:

Check that stop light lights up when brake pedal is depressed and turns off when brake pedal is released.

NG Repair stop light circuit (See page BE-33).

OK

2 Check voltage between terminal STP (A11 - 5) of ABS ECU and body ground.

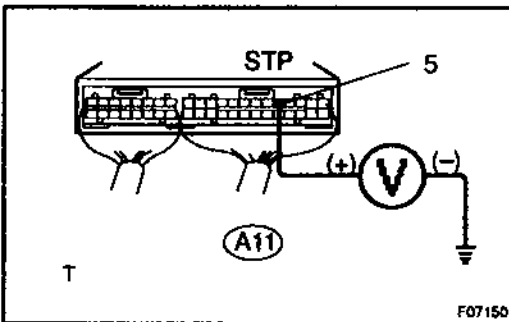

PREPARATION:

Remove ABS ECU with connectors still connected.

CHECK:

Measure voltage between terminal A11 - 5 of ABS ECU and body ground when brake pedal is depressed.

OK:

Voltage: 8 - 14 V

OK Check and replace ABS ECU.

NG

3 Check for open circuit in harness and connector between ABS ECU and stop light switch (See page IN-30).

NG Repair or replace harness or connector.

OK

Proceed to next circuit inspection shown on problem symptoms table (See page DI-284).

DTC	C1251/51	ABS Pump Motor Lock
------------	-----------------	----------------------------

CIRCUIT DESCRIPTION

DTC No.	DTC Detecting Condition	Trouble Area
C1251/51	ABS actuator pump motor is not operating normally.	ABS pump motor

WIRING DIAGRAM

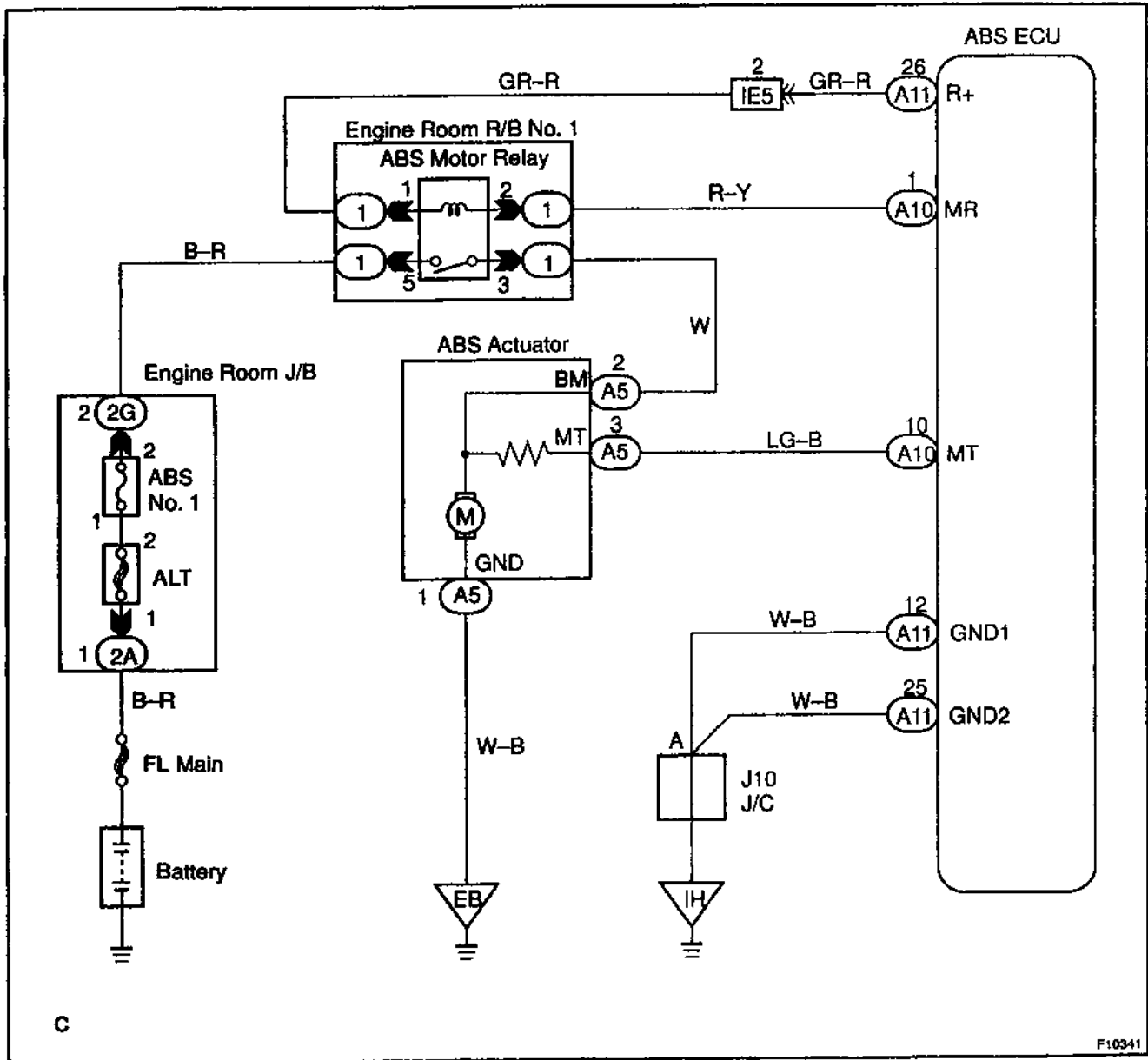

C

INSPECTION PROCEDURE

1 Check operation of ABS pump motor.

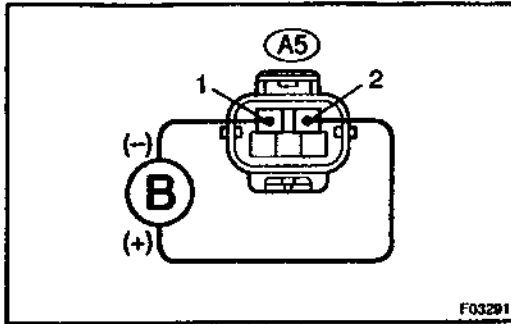

PREPARATION:

Disconnect the ABS actuator connector.

CHECK:

Connect positive \oplus lead to terminal BM (A5 - 2) and negative \ominus lead to terminal GND (A5 - 1) of the ABS actuator connector, check that the pump motor is operates.

OK:

The running sound of the pump motor should be heard.

OK

Check for open circuit in harness and connector between ABS motor relay, ABS actuator and ABS ECU (See page IN-30).

NG

Replace ABS actuator.

DTC	Always ON	ABS ECU Malfunction
------------	------------------	----------------------------

CIRCUIT DESCRIPTION

DTC No.	DTC Detecting Condition	Trouble Area
Always ON	ABS ECU internal malfunction is detected.	<ul style="list-style-type: none"> • Combination meter • Combination meter circuit • Battery • ABS ECU

INSPECTION PROCEDURE

1	Is DTC output?
----------	-----------------------

Check DTC on page DI-276.

YES**Repair circuit indicated by the code output.****NO**

2	Is normal code displayed?
----------	----------------------------------

YES**Check and replace ABS ECU.****NO**

3	Is ABS warning light go off?
----------	-------------------------------------

YES**Check and replace ABS ECU.****NO**

4	Check battery positive voltage.
----------	----------------------------------------

CHECK:

Check the battery positive voltage.

OK:

10 - 14 V

NG	Check and repair the charging system. (See page CH-2)
-----------	--------------------------------------------------------------

OK

5	Check ABS warning light.
----------	---------------------------------

PREPARATION:

- (a) Disconnect the connector from the ABS ECU.
- (b) Connect the terminal WA (A11 - 11) of wire harness and the terminal GND (A11 - 12, 25) of wire harness.
- (c) Turn the ignition switch ON.

CHECK:

Check the ABS warning light goes off.

OK	Check and replace ABS ECU.
-----------	-----------------------------------

NG

Check for short circuit in harness and connector between ABS warning light, combination meter and ABS ECU (See page IN-30).

ABS Warning Light Circuit

CIRCUIT DESCRIPTION

If the ECU detects trouble, it lights the ABS warning light while at the same time prohibiting ABS control. At this time, the ECU records a DTC in memory.

Connect terminals Tc and CG of the DLC3 to make the ABS warning light blink and output the DTC.

WIRING DIAGRAM

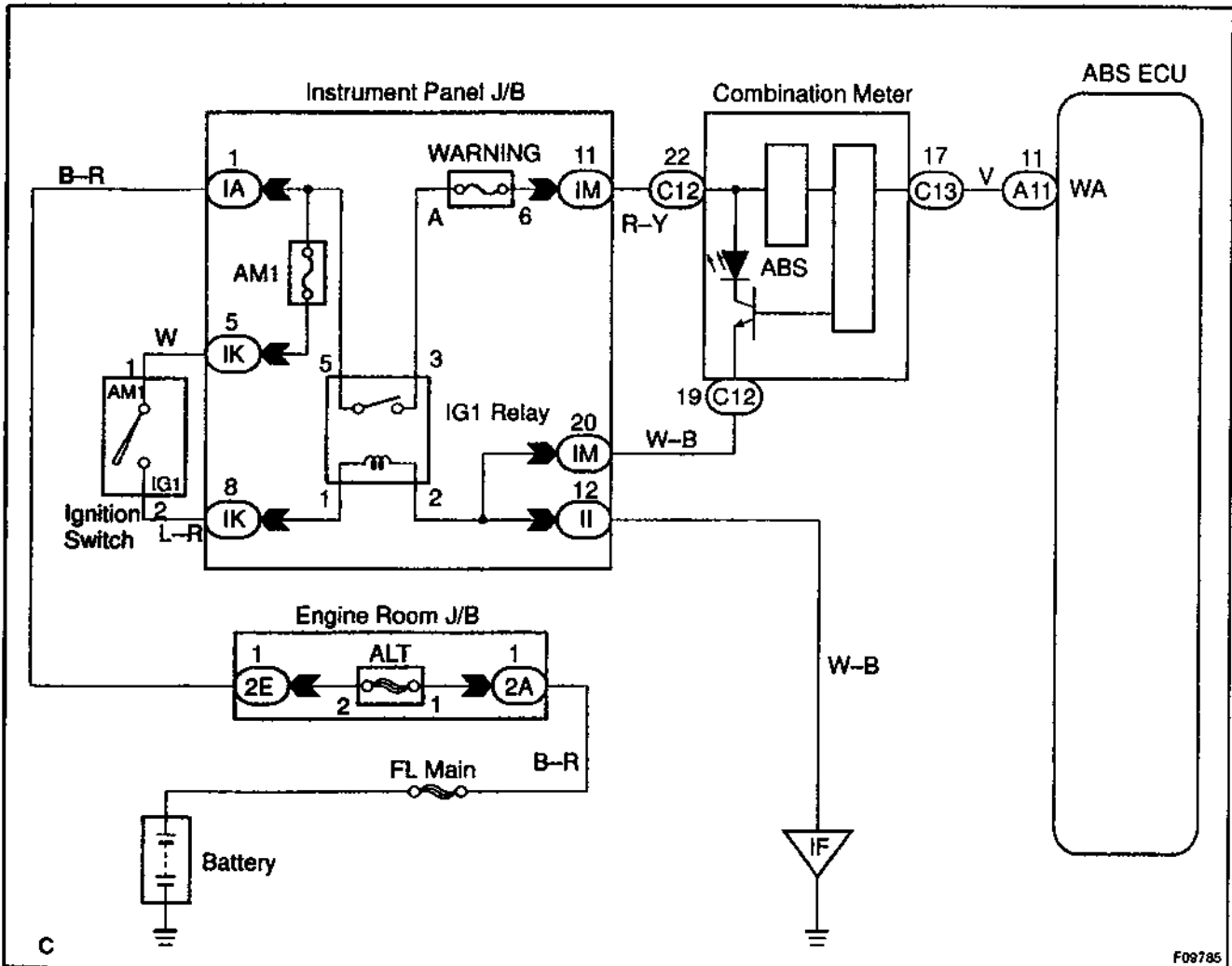

INSPECTION PROCEDURE

HINT:

Troubleshoot in accordance with the chart below for each trouble symptom.

ABS warning light does not light up	*1
ABS warning light remains on	*2

*1: Start the inspection from step 1 in case of using the TOYOTA hand-held tester and start from step 2 in case of not using TOYOTA hand-held tester.

*2: After inspection of step 3, start the inspection from step 4 in case of using the TOYOTA hand-held tester and start from step 5 in case of not using TOYOTA hand-held tester.

1	Check operation of the ABS warning light.
----------	--------------------------------------------------

PREPARATION:

- (a) Connect the TOYOTA hand-held tester to the DLC3.
- (b) Turn the ignition switch ON and push the TOYOTA hand-held tester main switch ON.
- (c) Select the ACTIVE TEST mode on the TOYOTA hand-held tester.

CHECK:

Check that "ON" of the ABS warning light can be shown on the combination meter using the TOYOTA hand-held tester.

HINT:

ABS warning light turns "OFF" automatically 2 seconds after it is turned "ON".



2	Check ABS warning light.
----------	---------------------------------

See combination meter troubleshooting on page BE-2.



3 Check that the ECU connectors are securely connected to the ECU.

NO

Connect the connector to the ECU.

YES

Check for open circuit in harness and connector between combination meter and ABS ECU (See page IN-30).

4 Check operation of the ABS warning light (See step 1).

OK

Check and replace ABS ECU.

NG

5 Is DTC output?

Check DTC on page DI-276.

YES

Repair circuit indicated by the output code.

NO

Check for short circuit in harness and connector between DLC3 and ABS ECU (See page IN-30).

BRAKE Warning Light Circuit

CIRCUIT DESCRIPTION

The BRAKE warning light lights up when the brake fluid is insufficient, the parking brake is applied or the EBD is defective.

WIRING DIAGRAM

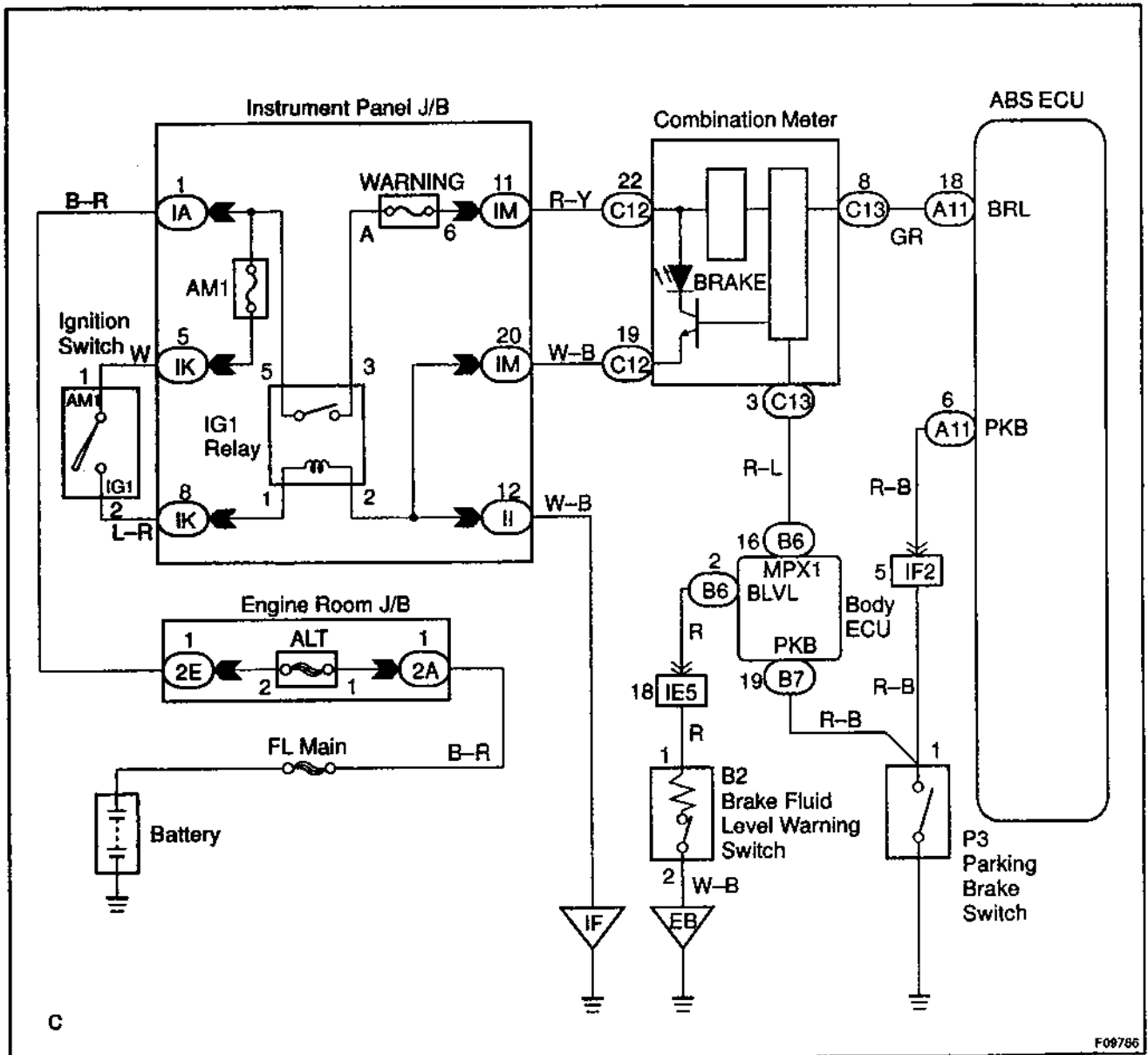

INSPECTION PROCEDURE

1 Check parking brake switch circuit (See page BE-2).

NG Repair or replace parking brake switch circuit.

OK

2 Check brake fluid level warning switch circuit (See page BE-2).

NG Repair or replace brake fluid level warning switch circuit.

OK

3 Is DTC output for ABS?

Check DTC on page DI-276.

Yes Repair circuit indicated by the output code.

No

4 Check BRAKE warning light.

See combination meter troubleshooting on page BE-2.

NG Repair or replace combination meter.

OK

Check and replace ABS ECU.

Tc Terminal Circuit

CIRCUIT DESCRIPTION

Connecting between terminals Tc and CG of the DLC3 causes the ECU to display the DTC by flashing the ABS warning light.

WIRING DIAGRAM

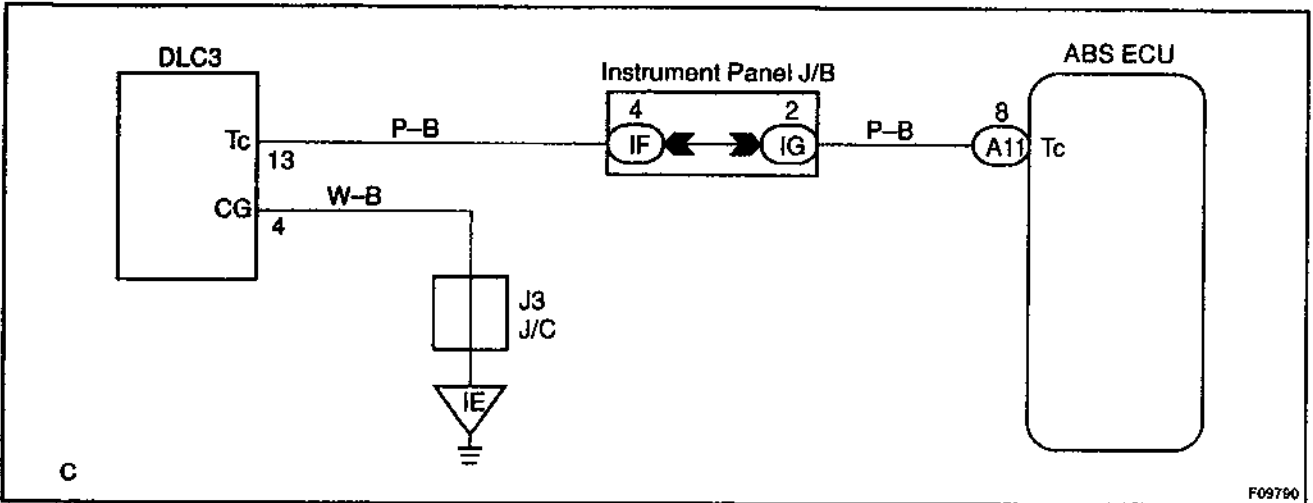

INSPECTION PROCEDURE

1	Check voltage between terminals Tc and CG of DLC3.
---	----------------------------------------------------

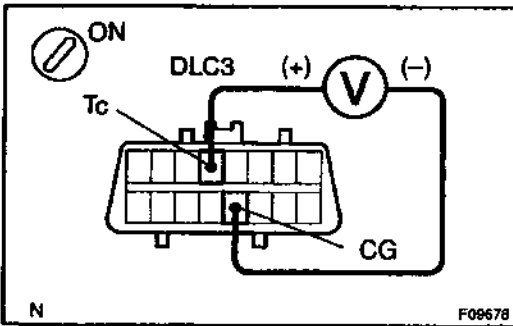

CHECK:

- (a) Turn the ignition switch ON.
- (b) Measure voltage between terminals Tc and CG of DLC3.

OK:

Voltage: 10 – 14 V

OK

If ABS warning light does not blink even after Tc and CG are connected, the ECU may be defective.

NG

2	Check for open and short circuit in harness and connector between ABS ECU and DLC3, DLC3 and body ground (See page IN-30).
---	----------------------------------------------------------------------------------------------------------------------------

NG

Repair or replace harness or connector.

OK

Check and replace ABS ECU.

Ts Terminal Circuit

CIRCUIT DESCRIPTION

The sensor check circuit detects abnormalities in the speed sensor signal which cannot be detected with the DTC check.

Connecting terminals Ts and CG of the DLC3 starts the check.

WIRING DIAGRAM

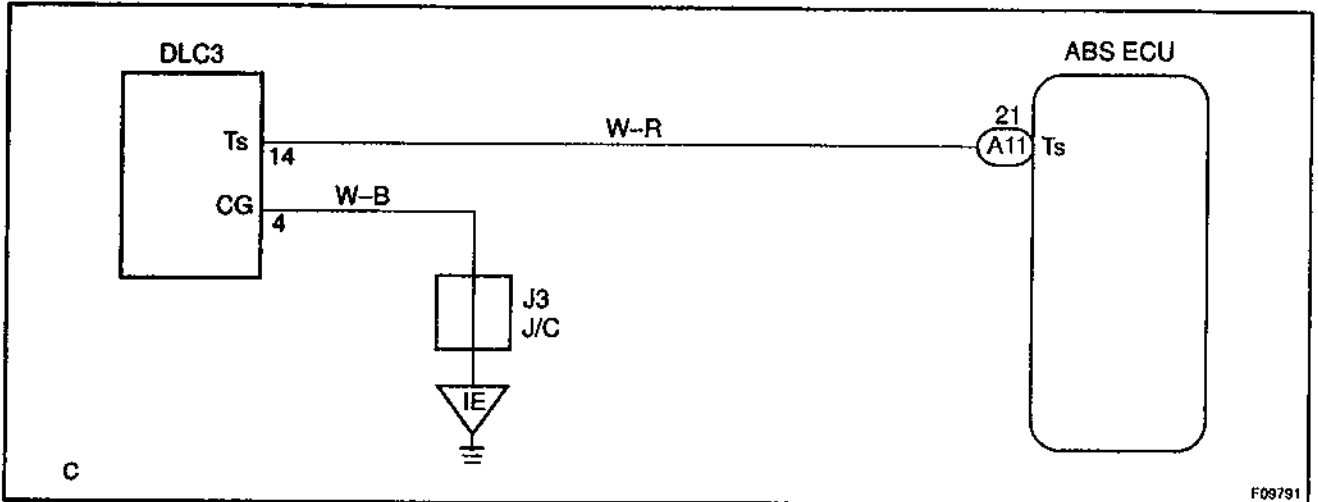

INSPECTION PROCEDURE

- 1 Check voltage between terminals Ts and CG of DLC3.

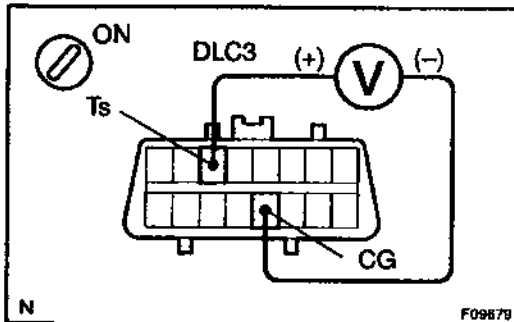

CHECK:

- Turn the ignition switch ON.
- Measure voltage between terminals Ts and CG of DLC3.

OK:

Voltage: 10 - 14 V

OK

If ABS warning light does not blink even after Ts and CG are connected, the ECU may be defective.

NG

2	Check for open and short circuit in harness and connector between ABS ECU and DLC3, DLC3 and body ground (See page IN-30).
----------	-----------------------------------------------------------------------------------------------------------------------------------

NG	Repair or replace harness or connector.
-----------	------------------------------------------------

OK

Check and replace ABS ECU.

Check for Fluid Leakage

Check for fluid leakage from actuator or hydraulic lines.

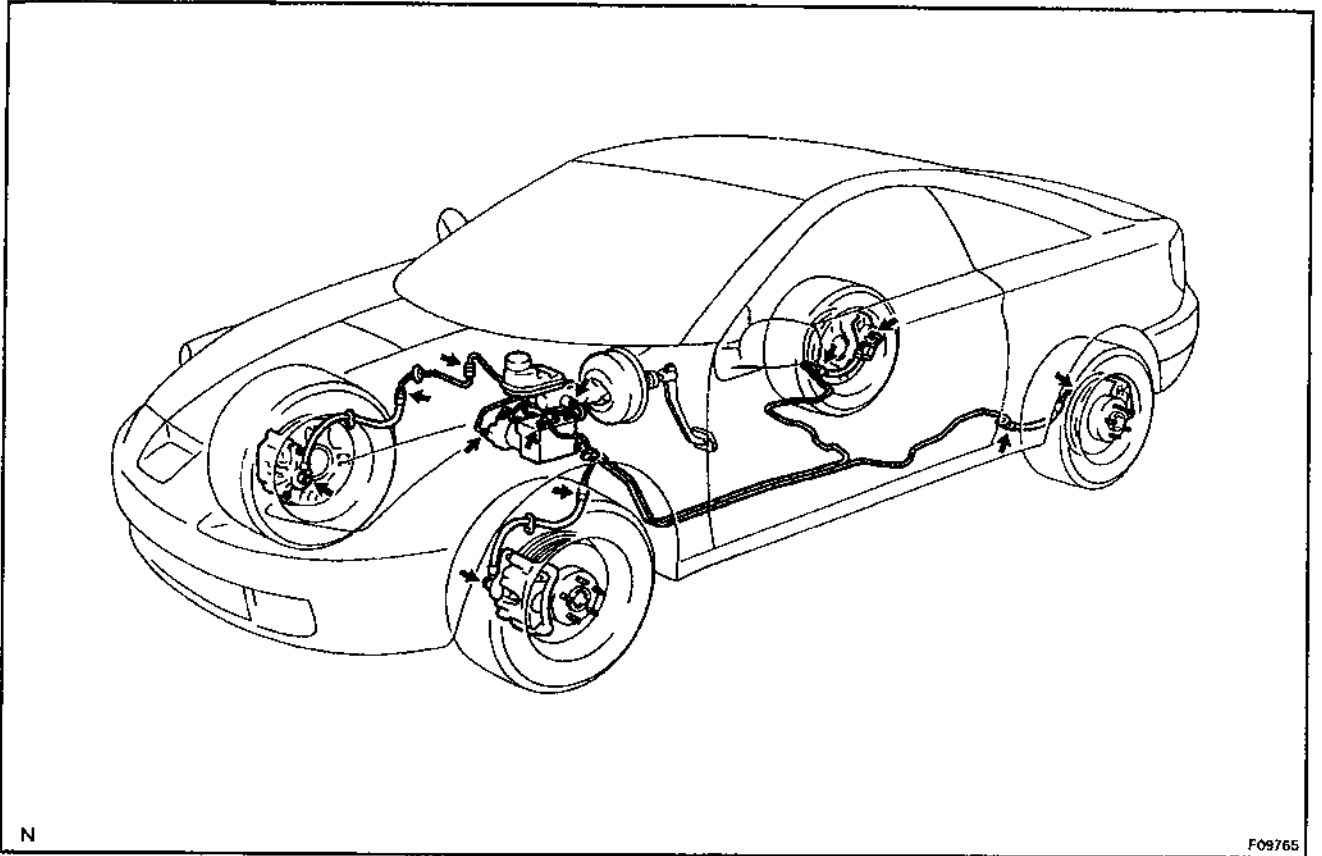

SUPPLEMENTAL RESTRAINT SYSTEM

HOW TO PROCEED WITH TROUBLESHOOTING

D40V-01

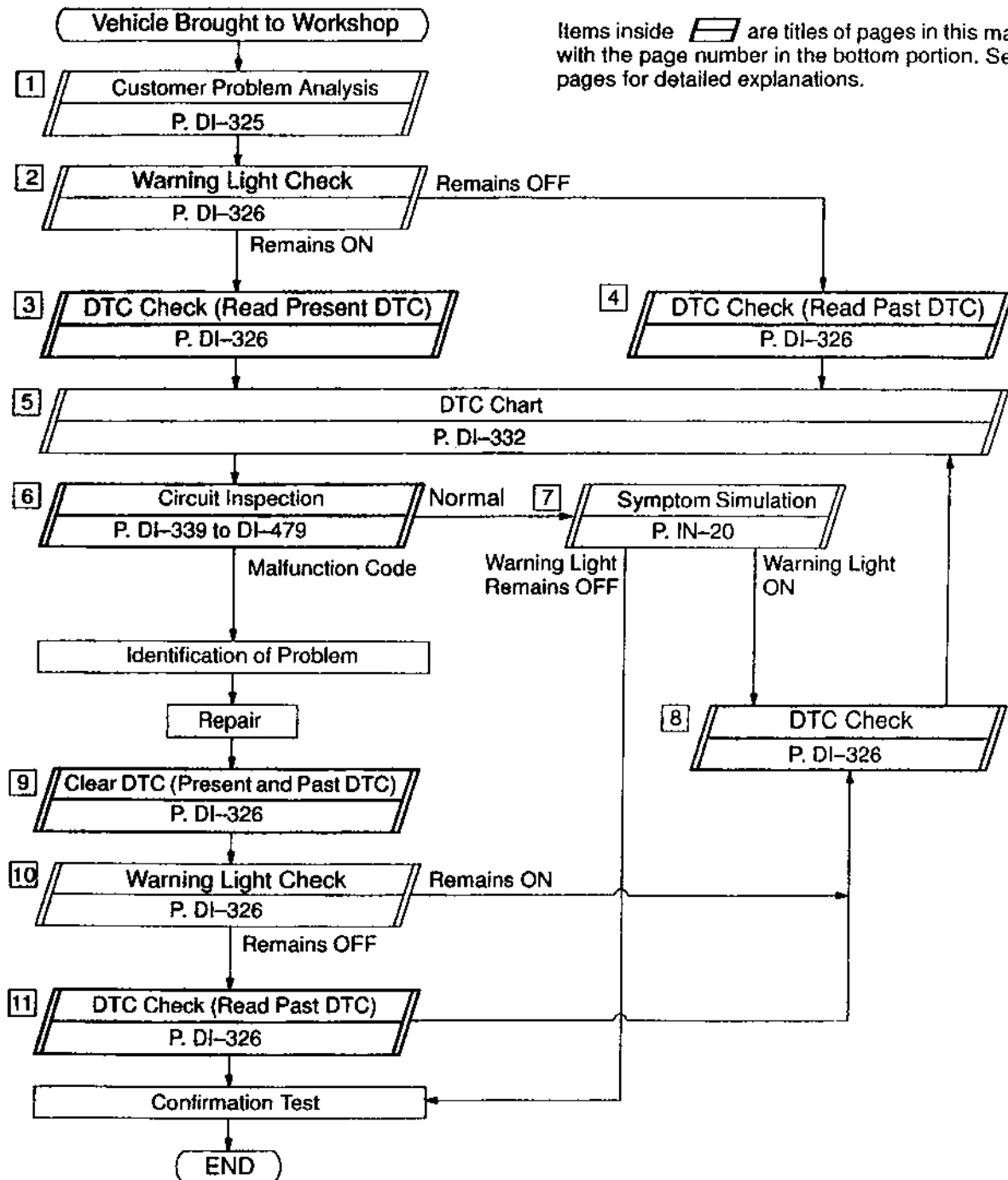

Step 3, 4, 6, 8, 9, 11 : Diagnostic steps permitting the use of the TOYOTA hand-held tester.

CUSTOMER PROBLEM ANALYSIS CHECK

DE0X-01

Supplemental Restraint System Check Sheet

Inspector's Name _____

Customer's Name		Registration No.	
		Registration Year	/ /
		Frame No.	
Date Vehicle Brought In	/ /	Odometer Reading	km Miles

Date Problem Occurred	/ /
Weather	<input type="checkbox"/> Fine <input type="checkbox"/> Cloudy <input type="checkbox"/> Rainy <input type="checkbox"/> Snowy <input type="checkbox"/> Other
Temperature	Approx. _____

Vehicle Operation	<input type="checkbox"/> Starting <input type="checkbox"/> Idling <input type="checkbox"/> Driving [<input type="checkbox"/> Constant speed <input type="checkbox"/> Acceleration <input type="checkbox"/> Deceleration <input type="checkbox"/> Other]
Road Conditions	
Details Of Problem	

Vehicle Inspection, Repair History Prior to Occurrence of Malfunction (Including Supplemental Restraint System)	
-----------------------------------------------------------------------------------------------------------------	--

Diagnosis System Inspection

SRS Warning Light Inspection	1st Time	<input type="checkbox"/> Remains ON <input type="checkbox"/> Sometimes Lights Up <input type="checkbox"/> Does Not Light Up
	2nd Time	<input type="checkbox"/> Remains ON <input type="checkbox"/> Sometimes Lights Up <input type="checkbox"/> Does Not Light Up
DTC Inspection	1st Time	<input type="checkbox"/> Normal Code <input type="checkbox"/> Malfunction Code [Code.]
	2nd Time	<input type="checkbox"/> Normal Code <input type="checkbox"/> Malfunction Code [Code.]

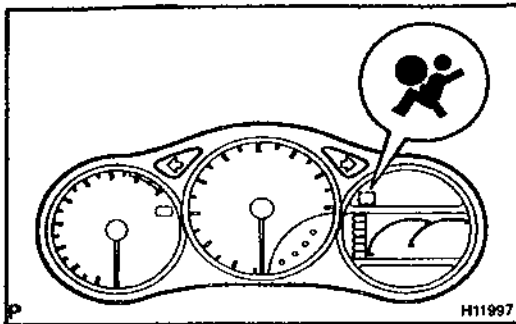

PRE-CHECK

1. SRS WARNING LIGHT CHECK

- (a) Turn the ignition switch to the ON position and check that the SRS warning light lights up.
- (b) Check that the SRS warning light goes out after approx. 6 seconds.

HINT:

- When the ignition switch is at ON and the SRS warning light remains on or flashes, the airbag sensor assembly has detected a malfunction code.
- If, after approx. 6 seconds have elapsed, the SRS warning light sometimes lights up or the SRS warning light lights up even when the ignition switch is OFF, a short in the SRS warning light circuit can be considered likely. Proceed to "SRS warning light circuit malfunction" on page DI-474.

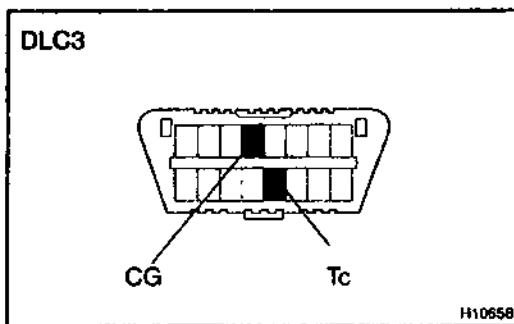

2. DTC CHECK (Using diagnosis check wire)

- (a) Present troubles codes:

Output the DTC.

- (1) Turn the ignition switch to the ON position and wait for approx. 20 seconds.
- (2) Using SST, connect terminals Tc and CG of the DLC3.

SST 09843-18020

NOTICE:

Pay due attention to the terminal connecting position to avoid a malfunction.

- (b) Past troubles codes:

Output the DTC.

- (1) Using service wire, connect terminals Tc and CG of the DLC3.

SST 09843-18020

- (2) Turn the ignition switch to the ON position and wait for approx. 20 seconds.

NOTICE:

Pay due attention to the terminal connecting position to avoid a malfunction.

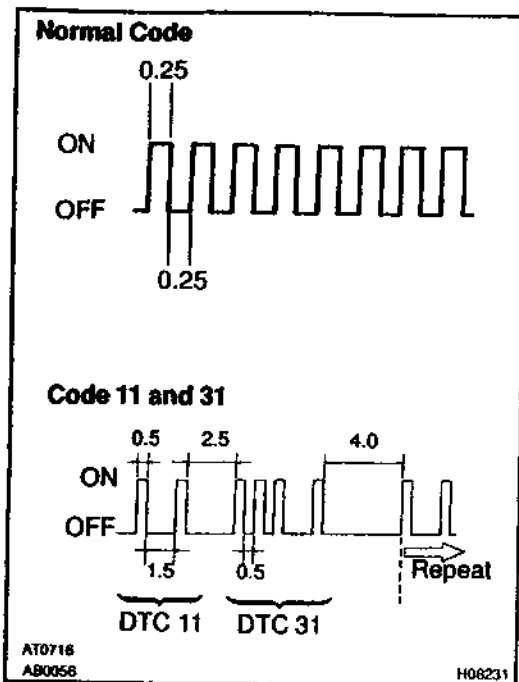

(c) Read the DTC.

Read the 2-digit DTC as indicated by the number of times the SRS warning light blinks. As an example, the blinking patterns, normal, 11 and 31 are shown in the illustration.

- Normal code indication
The light will blink 2 times per second.
- Malfunction code indication
The first blinking output indicates the first digit of a 2-digit DTC. After a 1.5-second pause, the second blinking output will indicate the second digit.

If there are 2 or more codes, there will be a 2.5-second pause between each code. After all the codes have been output, there will be a 4.0-second pause and they will all be repeated.

HINT:

- In the event of a number of trouble codes, indication will start from the smallest numbered code.
- If a DTC is not output or a DTC is output without terminal connection, proceed to the Tc terminal circuit inspection on page DI-479.

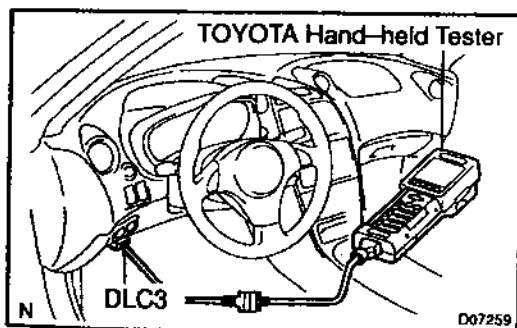

3. DTC CHECK (Using TOYOTA hand-held tester)

- Hook up the TOYOTA hand-held tester to the DLC3.
- Read the DTCs by following the prompts on the tester screen.

HINT:

Please refer to the TOYOTA hand-held tester operator's manual for further details.

4. DTC CLEARANCE (Not using service wire)

When the ignition switch is turned off, the diagnostic trouble code is cleared.

HINT:

DTC might not be cleared by turning the ignition switch OFF. In this case, proceed to the next step.

5. DTC CLEARANCE (Using service wire)

- Connect the 2 service wires to terminals Tc and A/B of DLC3.
- Turn the ignition switch to ON and wait for approx. 6 seconds.

- (c) Starting with the Tc terminal, ground alternately terminal Tc and terminal A/B twice each in cycles of 1.0 second. Make sure that the terminals are grounded. Ensure the terminal Tc remain grounded.

HINT:

When alternately grounding terminals Tc and A/B, release ground from one terminal and immediately ground the other terminal within an interval of 0.2 seconds.

If DTCs are not cleared, repeat the above procedure until the codes are cleared.

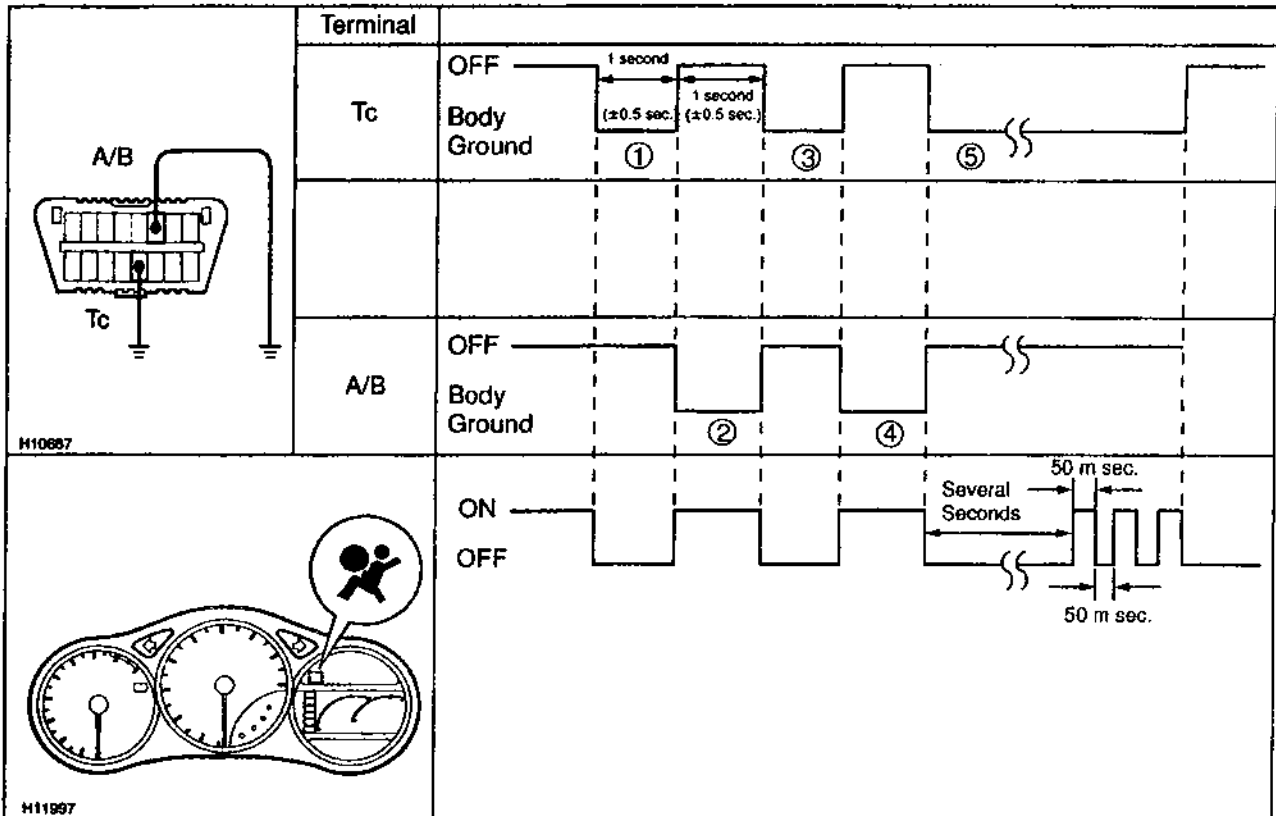

- (d) Several seconds after doing the clearing procedure, the SRS warning light will blink in a 50 – m sec. cycle to indicate the codes which have been cleared.

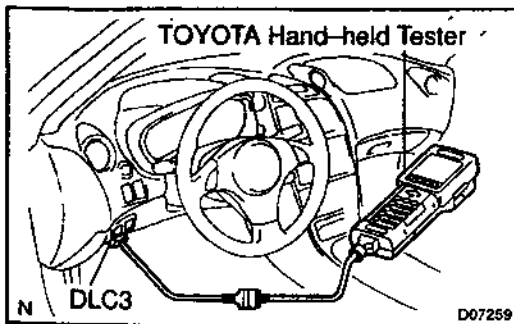
**6. DTC CLEARANCE (Using TOYOTA hand-held tester)**

- (a) Hook up the TOYOTA hand-held tester to the DLC3.
 (b) Clear the DTCs by following the prompts on the tester screen.

HINT:

Please refer to the TOYOTA hand-held tester operation's manual for further details.

7. RELEASE METHOD OF AIRBAG ACTIVATION PREVENTION MECHANISM

An airbag activation prevention mechanism is built into the connector for the squib circuit of the SRS.

When release of the airbag activation prevention mechanism is directed in the troubleshooting procedure, as shown in the illustration of the connectors on the next pages, insert paper which has the same thickness as the male terminal between the terminal and the short spring.

CAUTION:

Never release the airbag activation prevention mechanism on the squib connector.

NOTICE:

- **Do not release the airbag activation prevention mechanism unless specifically directed by the troubleshooting procedure.**
- **If the inserted paper is too thick the terminal and short spring may be damaged, so always use paper with the same thickness as the male terminal.**

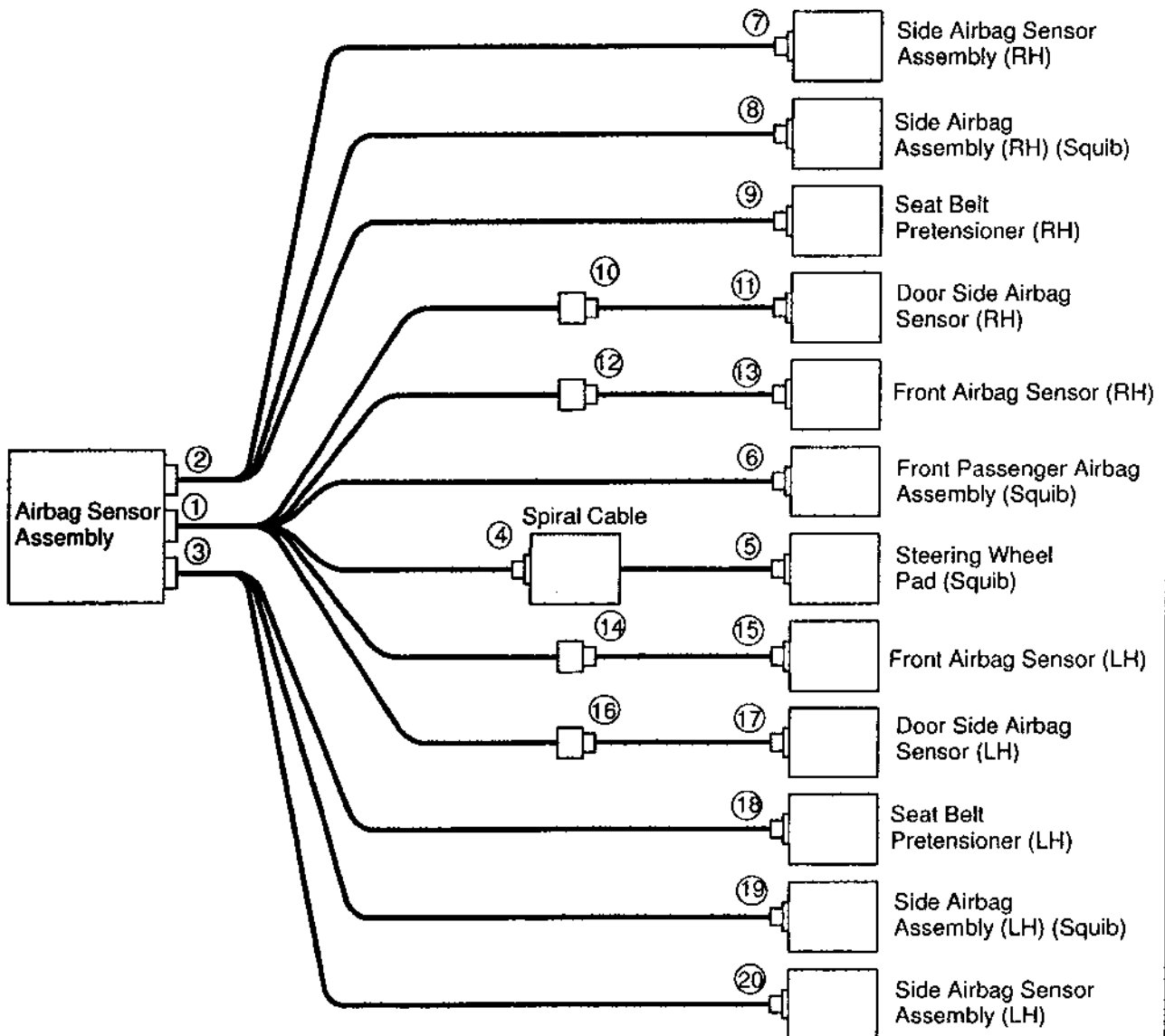

Airbag Sensor Assembly Connector

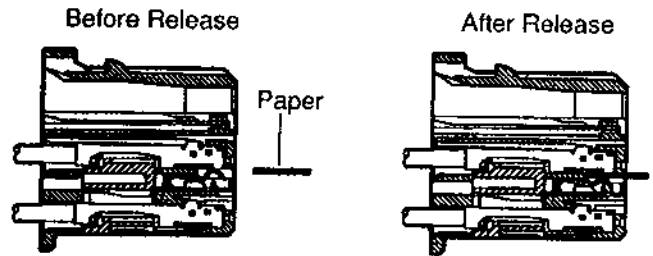
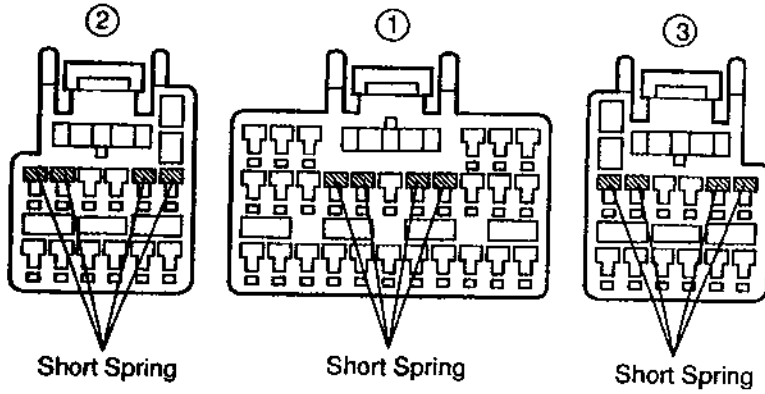

Connector ④ ⑤ ⑥

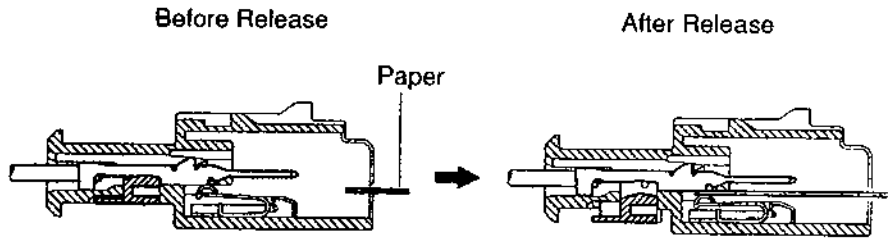

Connector ⑧ ⑨

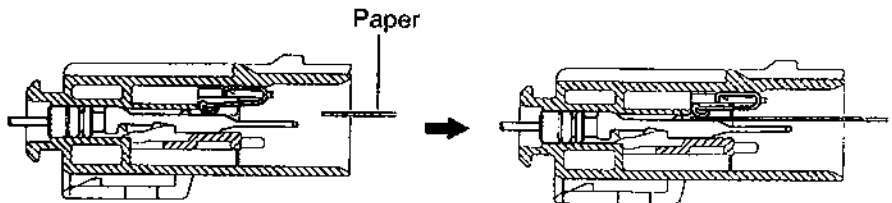
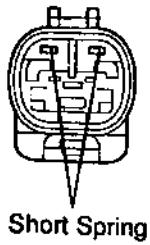

H01356
H01233
H02248 H02249
H09672 H09658

DIAGNOSTIC TROUBLE CODE CHART

If a malfunction code is displayed during the DTC check, check the circuit listed for that code in the table below (Proceed to the page given for that circuit.).

DTC No. (See Page)	Detection Item	Trouble Area	SRS Warning Light
B0100/13 (DI-339)	• Short in D squib circuit	• Steering wheel pad (squib) • Spiral cable • Airbag sensor assembly • Wire harness	ON
B0101/14 (DI-344)	• Open in D squib circuit	• Steering wheel pad (squib) • Spiral cable • Airbag sensor assembly • Wire harness	ON
B0102/11 (DI-348)	• Short in D squib circuit (to ground)	• Steering wheel pad (squib) • Spiral cable • Airbag sensor assembly • Wire harness	ON
B0103/12 (DI-352)	• Short in D squib circuit (to B+)	• Steering wheel pad (squib) • Spiral cable • Airbag sensor assembly • Wire harness	ON
B0105/53 (DI-356)	• Short in P squib circuit	• Front passenger airbag assembly (squib) • Airbag sensor assembly • Wire harness	ON
B0106/54 (DI-360)	• Open in P squib circuit	• Front passenger airbag assembly (squib) • Airbag sensor assembly • Wire harness	ON
B0107/51 (DI-363)	• Short in P squib circuit (to ground)	• Front passenger airbag assembly (squib) • Airbag sensor assembly • Wire harness	ON
B0108/52 (DI-366)	• Short in P squib circuit (to B+)	• Front passenger airbag assembly (squib) • Airbag sensor assembly • Wire harness	ON
B0110/43 (DI-369)	• Short in side squib (RH) circuit	• Side airbag assembly RH (squib) • Airbag sensor assembly • Wire harness	Blink
B0111/44 (DI-373)	• Open in side squib (RH) circuit	• Side airbag assembly RH (squib) • Airbag sensor assembly • Wire harness	Blink
B0112/41 (DI-379)	• Short in side squib (RH) circuit (to ground)	• Side airbag assembly RH (squib) • Airbag sensor assembly • Wire harness	Blink
B0113/42 (DI-379)	• Short in side squib (RH) circuit (to B+)	• Side airbag assembly RH (squib) • Airbag sensor assembly • Wire harness	Blink
B0115/47 (DI-382)	• Short in side squib (LH) circuit	• Side airbag assembly LH (squib) • Airbag sensor assembly • Wire harness	Blink
B0116/48 (DI-386)	• Open in side squib (LH) circuit	• Side airbag assembly LH (squib) • Airbag sensor assembly • Wire harness	Blink

DTC No. (See Page)	Detection Item	Trouble Area	SRS Warning Light
B0117/45 (DI-389)	• Short in side squib (LH) circuit (to ground)	• Side airbag assembly LH (squib) • Airbag sensor assembly • Wire harness	Blink
B0118/46 (DI-392)	• Short in side squib (LH) circuit (to B+)	• Side airbag assembly LH (squib) • Airbag sensor assembly • Wire harness	Blink
B0130/63 (DI-395)	• Short in P/T squib (RH) circuit	• Seat belt pretensioner RH (squib) • Airbag sensor assembly • Wire harness	Blink
B0131/64 (DI-399)	• Open in P/T squib (RH) circuit	• Seat belt pretensioner RH (squib) • Airbag sensor assembly • Wire harness	Blink
B0132/61 (DI-402)	• Short in P/T squib (RH) circuit (to ground)	• Seat belt pretensioner RH (squib) • Airbag sensor assembly • Wire harness	Blink
B0133/62 (DI-405)	• Short in P/T squib (RH) circuit (to B+)	• Seat belt pretensioner RH (squib) • Airbag sensor assembly • Wire harness	Blink
B0135/73 (DI-408)	• Short in P/T squib (LH) circuit	• Seat belt pretensioner LH (squib) • Airbag sensor assembly • Wire harness	Blink
B0136/74 (DI-412)	• Open in P/T squib (LH) circuit	• Seat belt pretensioner LH (squib) • Airbag sensor assembly • Wire harness	Blink
B0137/71 (DI-415)	• Short in P/T squib (LH) circuit (to ground)	• Seat belt pretensioner LH (squib) • Airbag sensor assembly • Wire harness	Blink
B0138/72 (DI-418)	• Short in P/T squib (LH) circuit (to B+)	• Seat belt pretensioner LH (squib) • Airbag sensor assembly • Wire harness	Blink
B1100/31 (DI-421)	• Airbag sensor assembly malfunction	• Airbag sensor assembly	ON
B1140/32 (DI-423)	• Side airbag sensor assembly (RH) malfunction	• Side airbag sensor assembly (RH) • Airbag sensor assembly • Wire harness	Blink
B1141/33 (DI-431)	• Side airbag sensor assembly (LH) malfunction	• Side airbag sensor assembly (LH) • Airbag sensor assembly • Wire harness	Blink
B1142/B1143/ 34 (DI-439)	• Door side airbag sensor (RH) malfunction	• Door side airbag sensor (RH) • Airbag sensor assembly • Instrument panel wire harness • RH front door wire harness	ON
B1144/B1145/ 35 (DI-447)	• Door side airbag sensor (LH) malfunction	• Door side airbag sensor (LH) • Airbag sensor assembly • Instrument panel wire harness • LH front door wire harness	ON
B1156/B1157/ 15 (DI-455)	• Front airbag sensor (RH) malfunction	• Front airbag sensor (RH) • Airbag sensor assembly • Instrument panel wire harness • Engine room No. 2 wire harness	ON

DTC No. (See Page)	Detection Item	Trouble Area	SRS Warning Light
B1158/B1159/ 16 (DI-463)	• Front airbag sensor (LH) malfunction	• Front airbag sensor (LH) • Airbag sensor assembly • Instrument panel wire harness • Engine room main wire harness	ON
Normal (DI-471)	• System normal	--	OFF
	• Voltage source drop	• Battery • Airbag sensor assembly	ON

HINT:

- When the SRS warning light remains lit up and the DTC is the normal code, this means a voltage source drops.
This malfunction is not stored in memory by the airbag sensor assembly and if the power source voltage returns to normal, the SRS warning light will automatically go out.
- When 2 or more codes are indicated, the codes will be displayed in numeral order starting from the lowest numbered code.
- If a code not listed on the chart is displayed, the airbag sensor assembly is faulty.

PARTS LOCATION

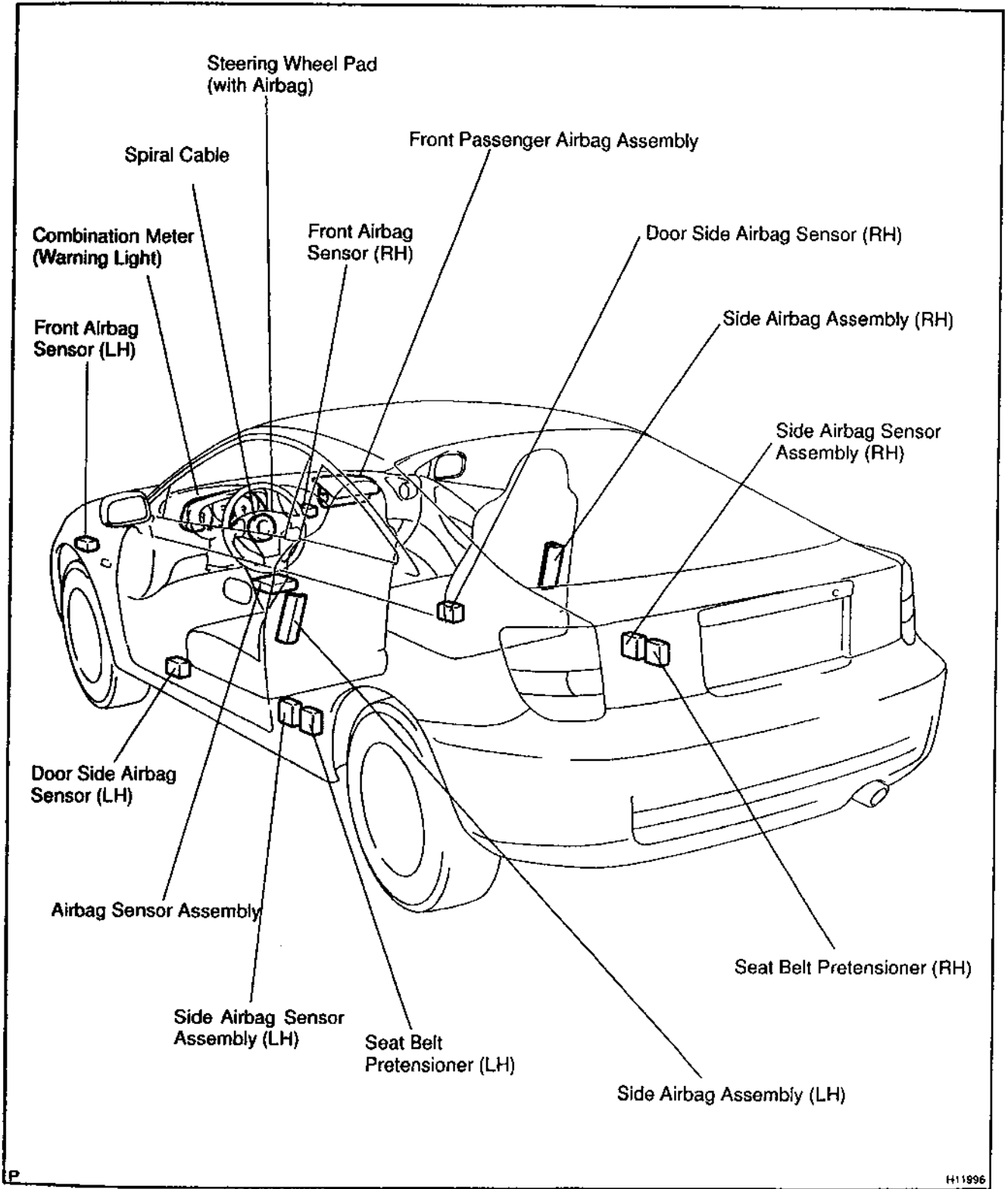

TERMINALS OF ECU

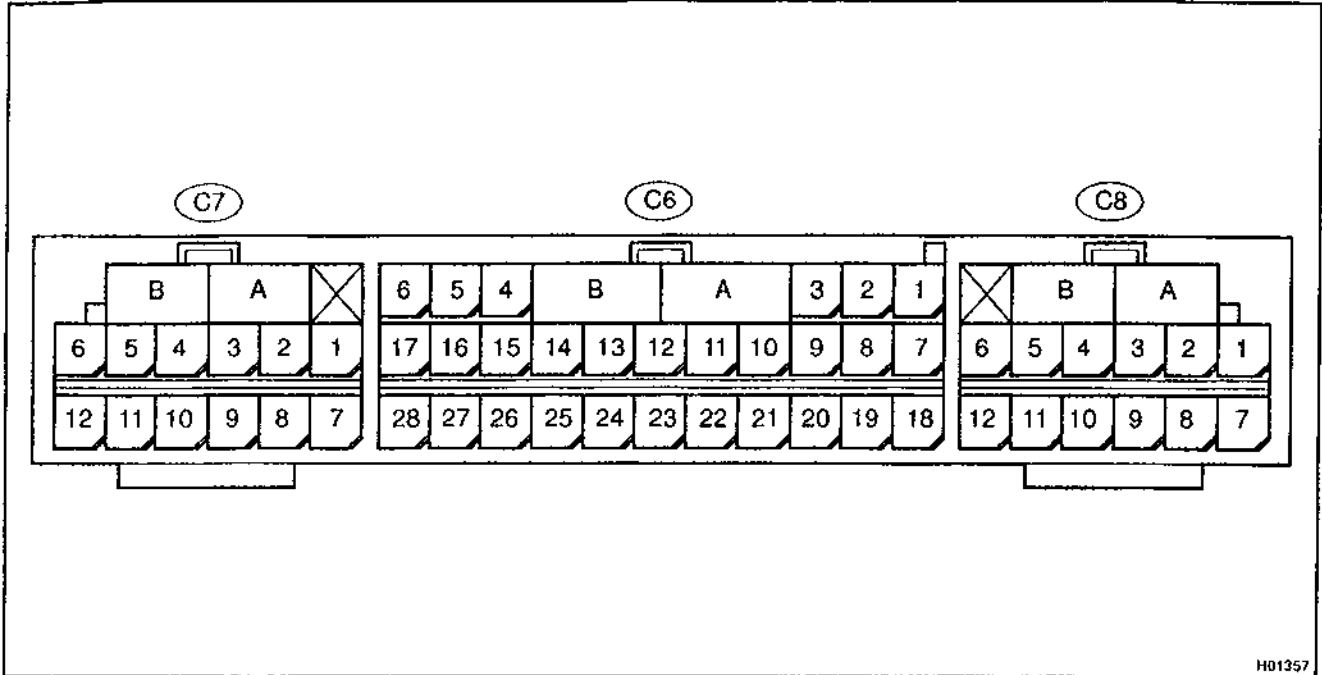

H01357

No.	Symbol	Terminal Name
A	-	Electrical Connector Check Mechanism
B	-	Electrical Connector Check Mechanism
C6-3	LA	SRS Warning Light
C6-5	IG2	Power Source
C6-6	IG1	Power Source
C6-7	DMR+	Door Side Airbag Sensor (RH)
C6-8	DMR-	Door Side Airbag Sensor (RH)
C6-9	+SR	Front Airbag Sensor (RH)
C6-10	P+	Squib (Passenger)
C6-11	P-	Squib (Passenger)
C6-12	SIL	Diagnosis
C6-13	D-	Squib (Driver)
C6-14	D+	Squib (Driver)
C6-15	+SL	Front Airbag Sensor (LH)
C6-16	DML-	Door Side Airbag Sensor (LH)
C6-17	DML+	Door Side Airbag Sensor (LH)
C6-19	Tc	Diagnosis
C6-20	-SR	Front Airbag Sensor (RH)
C6-23	GSW2	ECM
C6-26	-SL	Front Airbag Sensor (LH)
C6-27	E1	Ground
C6-28	E2	Ground
C7-1	PL-	Squib (Seat Belt Pretensioner, LH)
C7-2	PL+	Squib (Seat Belt Pretensioner, LH)
C7-5	SFL+	Squib (Side, LH)

No.	Symbol	Terminal Name
C7-6	SFL-	Squib (Side, LH)
C7-7	VUPL	Side Airbag Sensor (LH)
C7-9	SSL+	Side Airbag Sensor (LH)
C7-10	FSL	Side Airbag Sensor (LH)
C7-11	LBE+	Body ECU
C7-12	ESL	Side Airbag Sensor (LH)
C8-1	SFR-	Squib (Side, RH)
C8-2	SFR+	Squib (Side, RH)
C8-5	PR+	Squib (Pretensioner, RH)
C8-6	PR-	Squib (Pretensioner, RH)
C8-7	ESR	Side Airbag Sensor (RH)
C8-9	FSR	Side Airbag Sensor (RH)
C8-10	SSR+	Side Airbag Sensor (RH)
C8-12	VUPR	Side Airbag Sensor (RH)

PROBLEM SYMPTOMS TABLE

Proceed with troubleshooting of each circuit in the table below.

Symptom	Suspect Area	See page
<ul style="list-style-type: none"> • With the ignition switch in ON position, the SRS warning light sometimes lights up after approx. 6 seconds have elapsed. • SRS warning light is always lit up even when ignition switch is in the LOCK position. • With the ignition switch in ON position, the SRS warning light does not light up. 	<ul style="list-style-type: none"> • SRS warning light circuit 	DI-474
<ul style="list-style-type: none"> • DTC is not displayed. • SRS warning light is always lit up at the time of DTC check procedure. • DTC is displayed without Tc and E1 terminal connection. 	<ul style="list-style-type: none"> • Tc terminal circuit 	DI-479

CIRCUIT INSPECTION

DTC	B0100/13	Short in D Squib Circuit
------------	-----------------	---------------------------------

CIRCUIT DESCRIPTION

The D squib circuit consists of the airbag sensor assembly, spiral cable and steering wheel pad. It causes the airbag to deploy when the airbag deployment conditions are satisfied. For details of the function of each component, see OPERATION on page RS-2. DTC B0100/13 is recorded when a short is detected in the D squib circuit.

DTC No.	DTC Detecting Condition	Trouble Area
B0100/13	<ul style="list-style-type: none"> • Short circuit between D+ wire harness and D- wire harness of squib • D squib malfunction • Spiral cable malfunction • Airbag sensor assembly malfunction 	<ul style="list-style-type: none"> • Steering wheel pad (D squib) • Spiral cable • Airbag sensor assembly • Wire harness

WIRING DIAGRAM

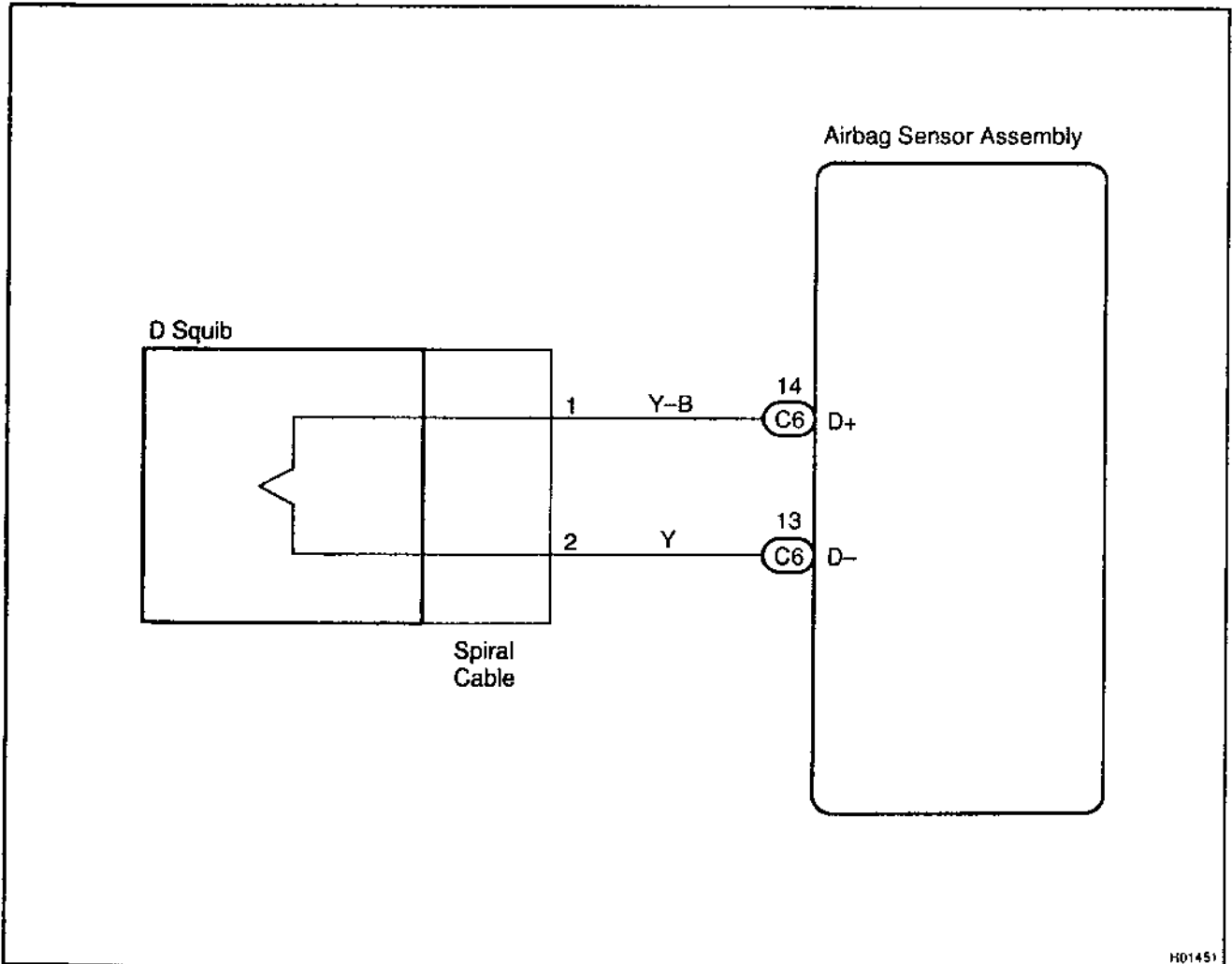

INSPECTION PROCEDURE

1 Prepare for inspection (See step 1 on page DI-471).

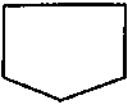

2 Check D squib circuit.

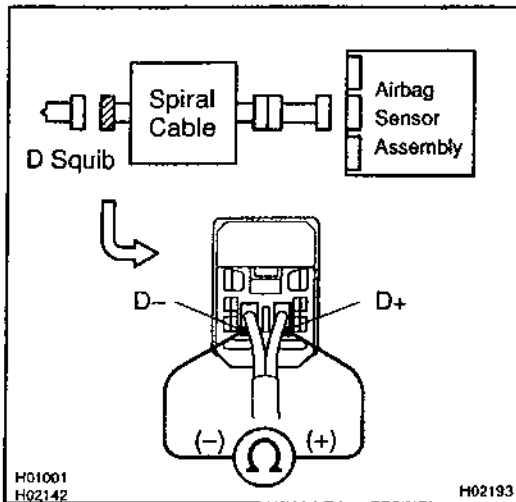
**PREPARATION:**

Release the airbag activation prevention mechanism of the connector (on the airbag sensor assembly side) between the airbag sensor assembly and the spiral cable (See page DI-326).

CHECK:

For the connector (on the spiral cable side) between the spiral cable and the steering wheel pad, measure the resistance between D+ and D-.

OK:

Resistance: 1 MΩ or Higher

NG

Go to step 5.

OK

3 Check airbag sensor assembly.

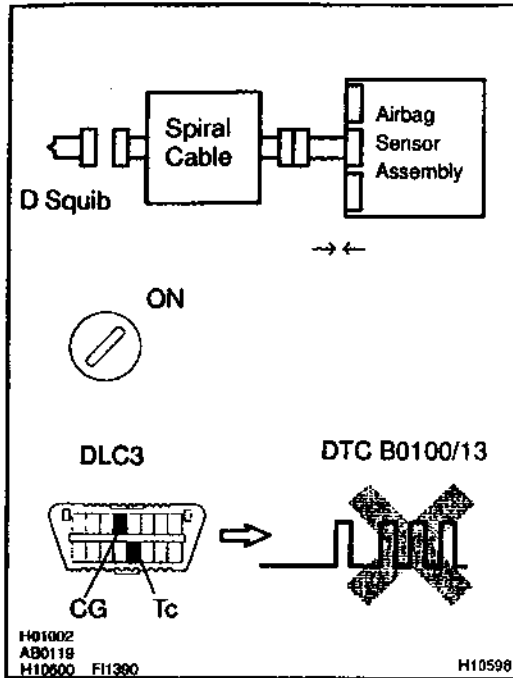

PREPARATION:

- Connect the connector to the airbag sensor assembly.
- Connect negative (-) terminal cable to the battery, and wait at least for 2 seconds.

CHECK:

- Turn the ignition switch to ON and wait at least for 20 seconds.
- Clear the DTC stored in memory (See page DI-326).
- Turn the ignition switch to LOCK, and wait at least for 20 seconds.
- Turn the ignition switch to ON, and wait at least for 20 seconds.
- Check the DTC (See page DI-326).

OK:

DTC B0100/13 is not output.

HINT:

Codes other than code B0100/13 may be output at this time, but they are not relevant to this check.

NG

Replace airbag sensor assembly.

OK

4

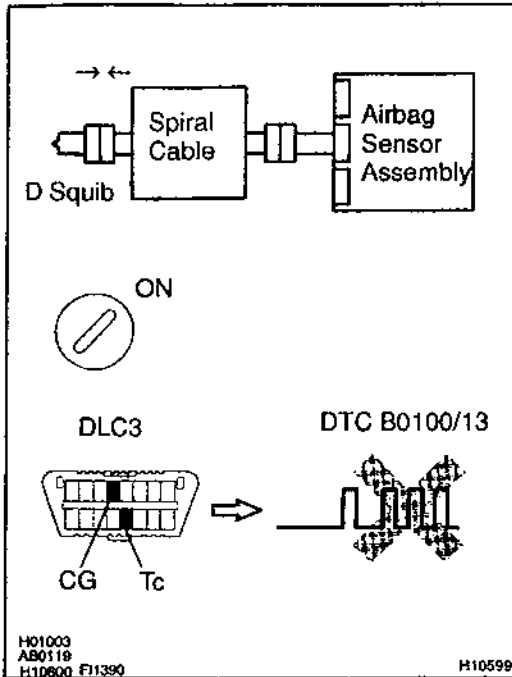
Check D squib.**PREPARATION:**

- Turn the ignition switch to LOCK.
- Disconnect negative (-) terminal cable from the battery, and wait at least for 90 seconds.
- Connect the steering wheel pad connector.
- Connect negative (-) terminal cable to the battery, and wait at least for 2 seconds.

CHECK:

- Turn the ignition switch to LOCK, and wait at least for 20 seconds.
- Turn the ignition switch to ON, and wait at least for 20 seconds.
- Clear the DTC stored in memory (See page DI-326).
- Turn the ignition switch to LOCK, and wait at least for 20 seconds.
- Turn the ignition switch to ON, and wait at least for 20 seconds.
- Check the DTC (See page DI-326).

OK:**DTC B0100/13 is not output.****HINT:**

Codes other than code B0100/13 may be output at this time, but they are not relevant to this check.

NG**Replace steering wheel pad.****OK**

From the results of the above inspection, the malfunctioning part can now be considered normal. To make sure of this, use the simulation method to check.

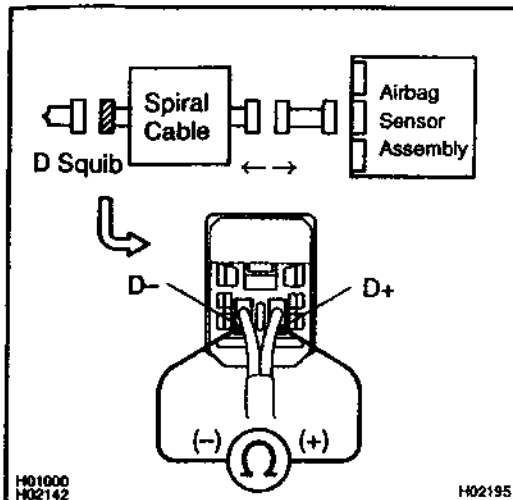
5 Check spiral cable.**PREPARATION:**

- Disconnect the connector between the airbag sensor assembly and the spiral cable.
- Release the airbag activation prevention mechanism of the spiral cable connector on the airbag sensor assembly side (See page DI-326).

CHECK:

For the connector (on the spiral cable side) between the spiral cable and the steering wheel pad, measure the resistance between D+ and D-.

OK:

Resistance: 1 MΩ or Higher

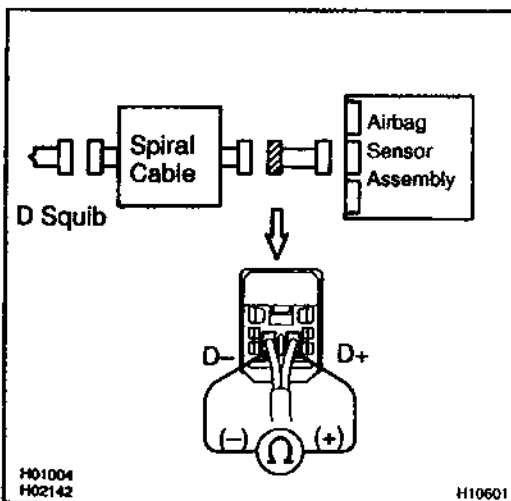
NG**Repair or replace spiral cable.****OK****6 Check harness between airbag sensor assembly and spiral cable.****PREPARATION:**

Release the airbag activation prevention mechanism of the connector (on the airbag sensor assembly side) between the airbag sensor assembly and the spiral cable (See page DI-326).

CHECK:

For the connector (on the spiral cable side) between the airbag sensor assembly and the spiral cable, measure the resistance between D+ and D-.

OK:

Resistance: 1 MΩ or Higher

NG**Repair or replace harness or connector between airbag sensor assembly and spiral cable.****OK**

From the results of the above inspection, the malfunctioning part can now be considered normal. To make sure of this, use the simulation method to check.

DTC	B0101/14	Open in D Squib Circuit
------------	-----------------	--------------------------------

CIRCUIT DESCRIPTION

The D squib circuit consists of the airbag sensor assembly, spiral cable and steering wheel pad. It causes the airbag to deploy when the airbag deployment conditions are satisfied.

For details of the function of each component, see OPERATION on page RS-2.

DTC B0101/14 is recorded when an open is detected in the D squib circuit.

DTC No.	DTC Detecting Condition	Trouble Area
B0101/14	<ul style="list-style-type: none"> • Open circuit in D+ wire harness or D- wire harness of squib • D squib malfunction • Spiral cable malfunction • Airbag sensor assembly malfunction 	<ul style="list-style-type: none"> • Steering wheel pad (D squib) • Spiral cable • Airbag sensor assembly • Wire harness

WIRING DIAGRAM

See page DI-339.

INSPECTION PROCEDURE

1	Prepare for inspection (See step 1 on page DI-471).
----------	------------------------------------------------------------

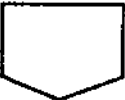

2	Check D squib circuit.
----------	-------------------------------

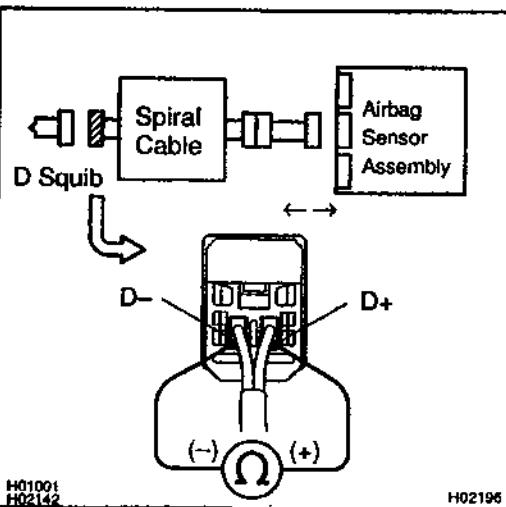

CHECK:

For the connector (on the spiral cable side) between the spiral cable and the steering wheel pad, measure the resistance between D+ and D-.

OK:

Resistance: Below 1 Ω

NG

Go to step 5.

OK

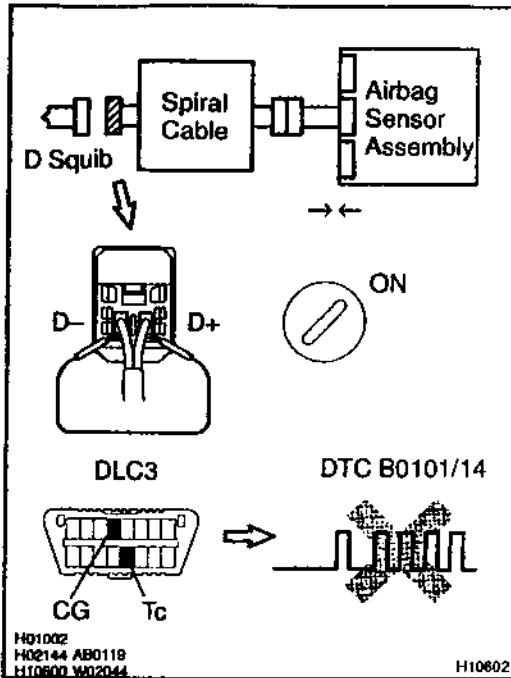
3 Check airbag sensor assembly.**PREPARATION:**

- Connect the connector to the airbag sensor assembly.
- Using a service wire, connect D+ and D- of the connector (on the spiral cable side) between the spiral cable and the steering wheel pad.
- Connect negative (-) terminal cable to the battery, and wait at least for 2 seconds.

CHECK:

- Turn the ignition switch to ON, and wait at least for 20 seconds.
- Clear the DTC stored in memory (See page DI-326).
- Turn the ignition switch to LOCK, and wait at least for 20 seconds.
- Turn the ignition switch to ON, and wait at least for 20 seconds.
- Check the DTC (See page DI-326).

OK:

DTC B0101/14 is not output.

HINT:

Codes other than code B0101/14 may be output at this time, but they are not relevant to this check.

NG

Replace airbag sensor assembly.

OK

4

Check D squib.

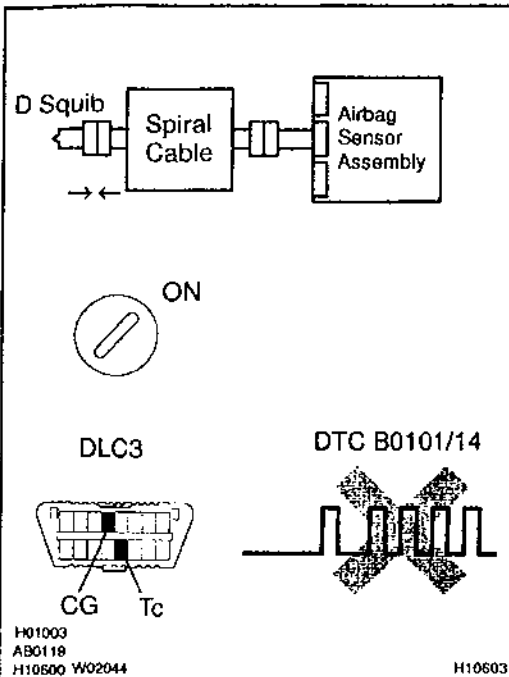
**PREPARATION:**

- Turn the ignition switch to LOCK.
- Disconnect negative (-) terminal cable from the battery, and wait at least for 90 seconds.
- Connect the steering wheel pad connector.
- Connect negative (-) terminal cable to the battery, and wait at least for 2 seconds.

CHECK:

- Turn the ignition switch to ON, and wait at least for 20 seconds.
- Clear the DTC stored in memory (See page DI-326).
- Turn the ignition switch to LOCK, and wait at least for 20 seconds.
- Turn the ignition switch to ON, and wait at least for 20 seconds.
- Check the DTC (See page DI-326).

OK:

DTC B0101/14 is not output.

HINT:

Codes other than code B0101/14 may be output at this time, but they are not relevant to this check.

NG

Replace steering wheel pad.

OK

From the results of the above inspection, the malfunctioning part can now be considered normal. To make sure of this, use the simulation method to check.

5 Check spiral cable.

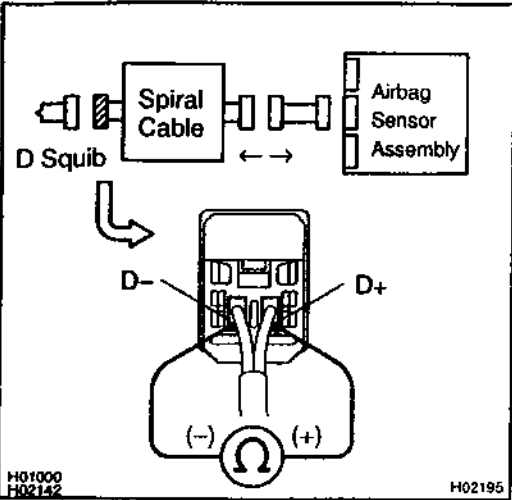

PREPARATION:

Disconnect the connector between the airbag sensor assembly and the spiral cable.

CHECK:

For the connector (on the spiral cable side) between the spiral cable and the steering wheel pad, measure the resistance between D+ and D-.

OK:

Resistance: Below 1 Ω

NG Repair or replace spiral cable.

OK

6 Check harness between airbag sensor assembly and spiral cable.

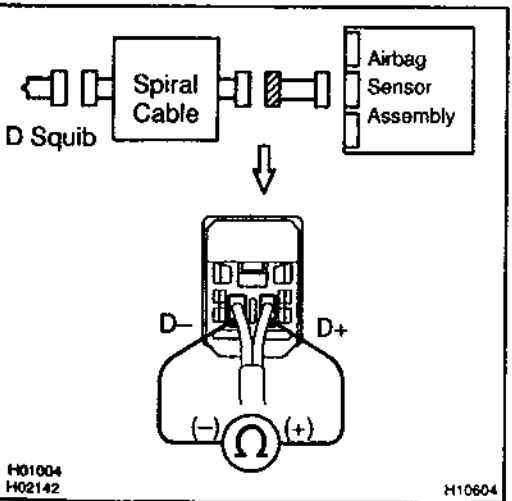

CHECK:

For the connector (on the spiral cable side) between the airbag sensor assembly and the spiral cable, measure the resistance between D+ and D-.

OK:

Resistance: Below 1 Ω

NG Repair or replace harness or connector between airbag sensor assembly and spiral cable.

OK

From the results of the above inspection, the malfunctioning part can now be considered normal. To make sure of this, use the simulation method to check.

DTC	B0102/11	Short in D Squib Circuit (to Ground)
------------	-----------------	---------------------------------------------

CIRCUIT DESCRIPTION

The D squib circuit consists of the airbag sensor assembly, spiral cable and steering wheel pad.

It causes the SRS to deploy when the SRS deployment conditions are satisfied.

For details of the function of each component, see OPERATION on page RS-2.

DTC B0102/11 is recorded when a ground short is detected in the D squib circuit.

DTC No.	DTC Detecting Condition	Trouble Area
B0102/11	<ul style="list-style-type: none"> • Short circuit in D squib wire harness (to ground) • D squib malfunction • Spiral cable malfunction • Airbag sensor assembly malfunction 	<ul style="list-style-type: none"> • Steering wheel pad (D squib) • Spiral cable • Airbag sensor assembly • Wire harness

WIRING DIAGRAM

See page DI-339.

INSPECTION PROCEDURE

1	Prepare for inspection (See step 1 on page DI-471).
----------	------------------------------------------------------------



2	Check D squib circuit.
----------	-------------------------------

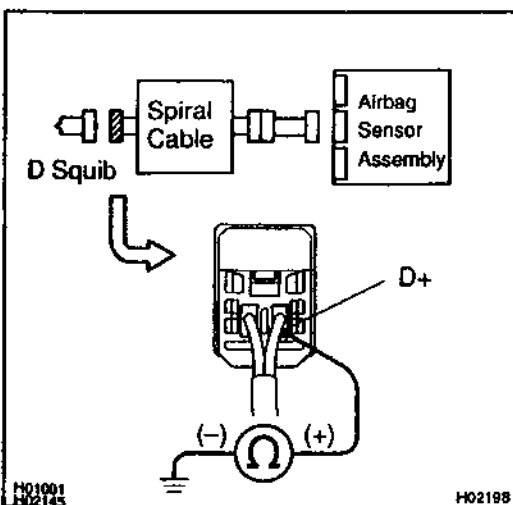

CHECK:

For the connector (on the spiral cable side) between the spiral cable and the steering wheel pad, measure the resistance between D+ and body ground.

OK:

Resistance: 1 MΩ or Higher

NG

Go to step 5.

OK

3 Check airbag sensor assembly.

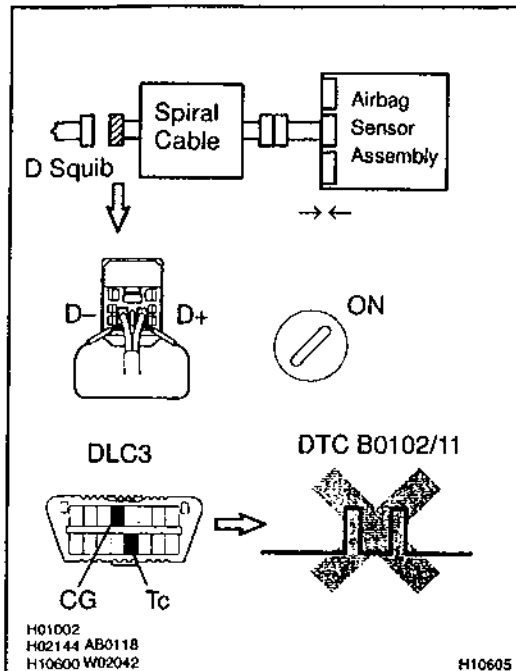

PREPARATION:

- Connect the connector to the airbag sensor assembly.
- Using a service wire, connect D+ and D- of the connector (on the spiral cable side) between the spiral cable and the steering wheel pad.
- Connect negative (-) terminal cable to the battery, and wait at least for 2 seconds.

CHECK:

- Turn the ignition switch to ON, and wait at least for 20 seconds.
- Clear the DTC stored in memory (See step 5 on page DI-326).
- Turn the ignition switch to LOCK, and wait at least for 20 seconds.
- Turn the ignition switch to ON, and wait at least for 20 seconds.
- Check the DTC (See page DI-326).

OK:

DTC B0102/11 is not output.

HINT:

Codes other than code B0102/11 may be output at this time, but they are not relevant to this check.

NG

Replace airbag sensor assembly.

OK

4 Check D squib.

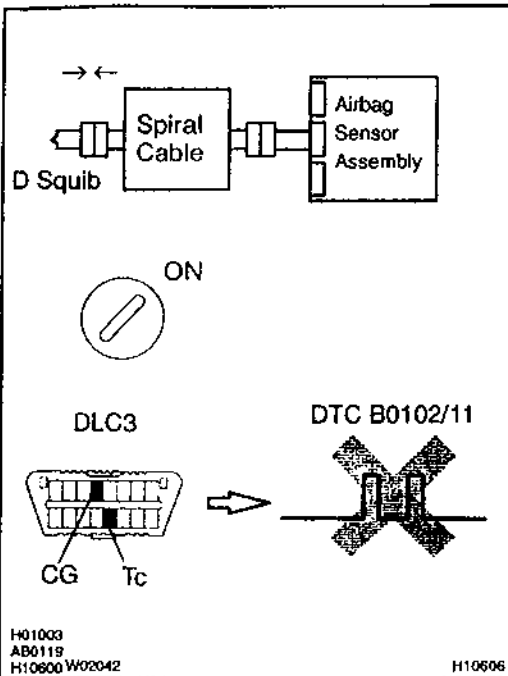

PREPARATION:

- Turn the ignition switch to LOCK.
- Disconnect negative (-) terminal cable from the battery, and wait at least for 90 seconds.
- Connect the steering wheel pad connector.
- Connect negative (-) terminal cable to the battery, and wait at least for 2 seconds.

CHECK:

- Turn the ignition switch to ON, and wait at least for 20 seconds.
- Clear the DTC stored in memory (See step 5 on page DI-326).
- Turn the ignition switch to LOCK, and wait at least for 20 seconds.
- Turn the ignition switch to ON, and wait at least for 20 seconds.
- Check the DTC (See page DI-326).

OK:

DTC B0102/11 is not output.

HINT:

Codes other than code B0102/11 may be output at this time, but they are not relevant to this check.

NG

Replace steering wheel pad.

OK

From the results of the above inspection, the malfunctioning part can now be considered normal. To make sure of this, use the simulation method to check. If the malfunctioning part can not be detected by the simulation method, replace all SRS components including the wire harness.

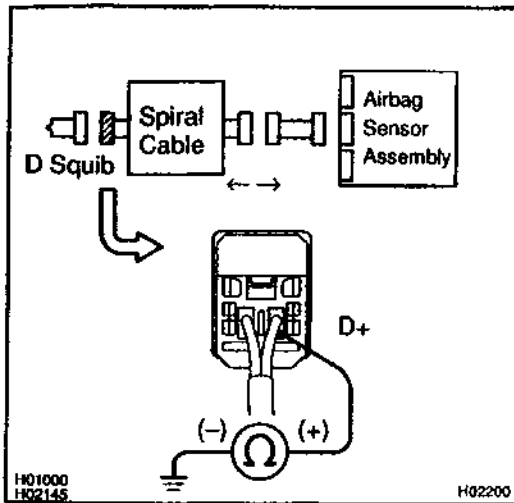
5 Check spiral cable.**PREPARATION:**

Disconnect the connector between the airbag sensor assembly and the spiral cable.

CHECK:

For the connector (on the spiral cable side) between the steering wheel pad and the spiral cable, measure the resistance between D+ and body ground.

OK:

Resistance: 1 MΩ or Higher

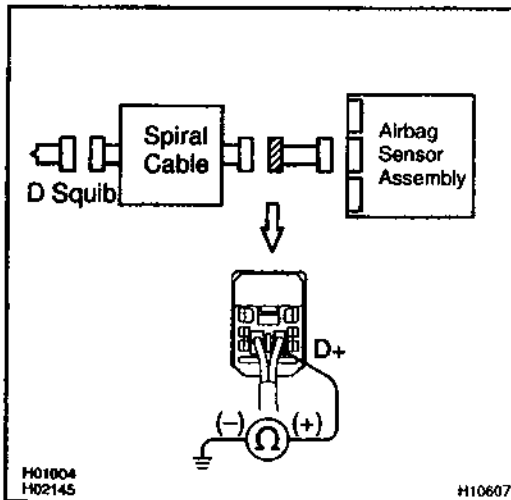
NG**Repair or replace spiral cable.****OK****6 Check harness between airbag sensor assembly and spiral cable.****CHECK:**

For the connector (on the spiral cable side) between the spiral cable and the airbag sensor assembly, measure the resistance between D+ and body ground.

OK:

Resistance: 1 MΩ or Higher

NG**Repair or replace harness between airbag sensor assembly and spiral cable.****OK**

From the results of the above inspection, the malfunctioning part can now be considered normal. To make sure of this, use the simulation method to check. If the malfunctioning part can not be detected by the simulation method, replace all SRS components including the wire harness.

DTC	B0103/12	Short in D Squib Circuit (to B+)
------------	-----------------	-----------------------------------------

CIRCUIT DESCRIPTION

The D squib circuit consists of the airbag sensor assembly, spiral cable and steering wheel pad.

It causes the SRS to deploy when the SRS deployment conditions are satisfied.

For details of the function of each component, see OPERATION on page RS-2.

DTC B0103/12 is recorded when a B+ short is detected in the D squib circuit.

DTC No.	DTC Detecting Condition	Trouble Area
B0103/12	<ul style="list-style-type: none"> • Short circuit in D squib wire harness (to B+) • D squib malfunction • Spiral cable malfunction • Airbag sensor assembly malfunction 	<ul style="list-style-type: none"> • Steering wheel pad (D squib) • Spiral cable • Airbag sensor assembly • Wire harness

WIRING DIAGRAM

See page DI-339.

INSPECTION PROCEDURE

1	Prepare for inspection (See step 1 on page DI-471).
----------	------------------------------------------------------------

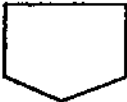

2	Check D squib circuit.
----------	-------------------------------

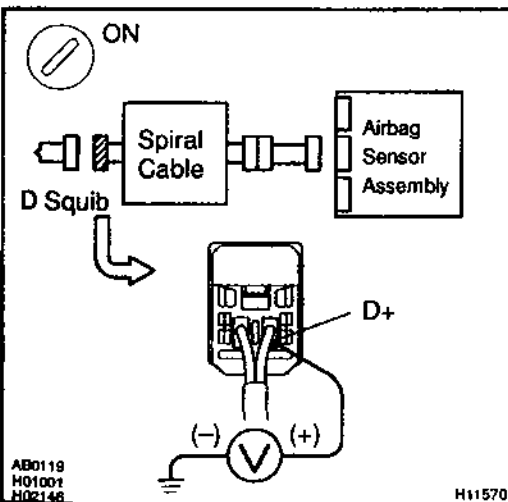

CHECK:

- (a) Turn ignition switch to ON.
- (b) For the connector (on the spiral cable side) between the spiral cable and the steering wheel pad, measure the voltage between D+ and body ground.

OK:

Voltage: 0 V

NG

Go to step 5.

OK

3 Check airbag sensor assembly.

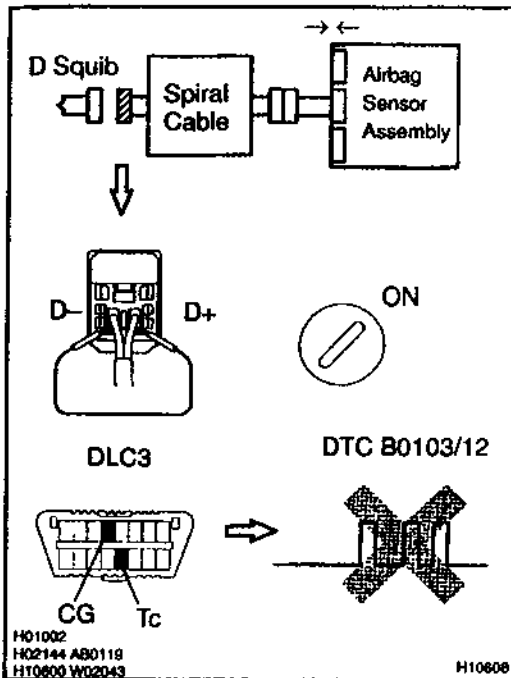

PREPARATION:

- Connect the connector to the airbag sensor assembly.
- Using a service wire, connect D+ and D- of the connector (on the spiral cable side) between the spiral cable and the steering wheel pad.
- Connect negative (-) terminal cable to the battery, and wait at least for 2 seconds.

CHECK:

- Turn the ignition switch to ON, and wait at least for 20 seconds.
- Clear the DTC stored in memory (See step 5 on page DI-326).
- Turn the ignition switch to LOCK, and wait at least for 20 seconds.
- Turn the ignition switch to ON, and wait at least for 20 seconds.
- Check the DTC (See page DI-326).

OK:

DTC B0103/12 is not output.

HINT:

Codes other than code B0103/12 may be output at this time, but they are not relevant to this check.

NG

Replace airbag sensor assembly.

OK

4 Check D squib.

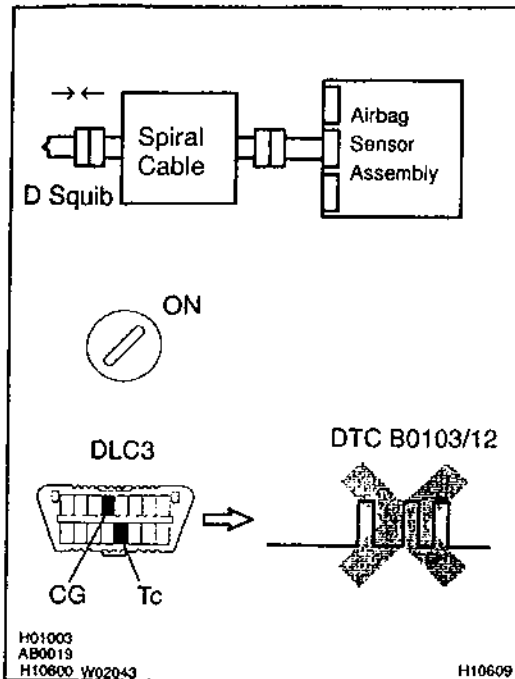

PREPARATION:

- Turn the ignition switch to LOCK.
- Disconnect negative (-) terminal cable from the battery, and wait at least for 90 seconds.
- Connect the steering wheel pad connector.
- Connect negative (-) terminal cable to the battery, and wait at least for 2 seconds.

CHECK:

- Turn the ignition switch to ON, and wait at least for 20 seconds.
- Clear the DTC stored in memory (See step 5 on page DI-326).
- Turn the ignition switch to LOCK, and wait at least for 20 seconds.
- Turn the ignition switch to ON, and wait at least for 20 seconds.
- Check the DTC (See page DI-326).

OK:

DTC B0103/12 is not output.

HINT:

Codes other than code B0103/12 may be output at this time, but they are not relevant to this check.

NG

Replace steering wheel pad.

OK

From the results of the above inspection, the malfunctioning part can now be considered normal. To make sure of this, use the simulation method to check. If the malfunctioning part can not be detected by the simulation method, replace all SRS components including the wire harness.

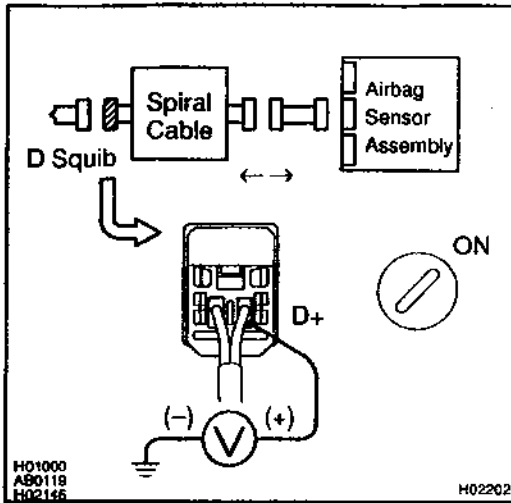
5 Check spiral cable.**PREPARATION:**

- Turn the ignition switch to LOCK.
- Disconnect the connector between the airbag sensor assembly and the spiral cable.

CHECK:

- Turn the ignition switch to ON.
- For the connector (on the spiral cable side) between the spiral cable and the steering wheel pad, measure the voltage between D+ and body ground.

OK:

Voltage: 0 V

NG

Repair or replace spiral cable.

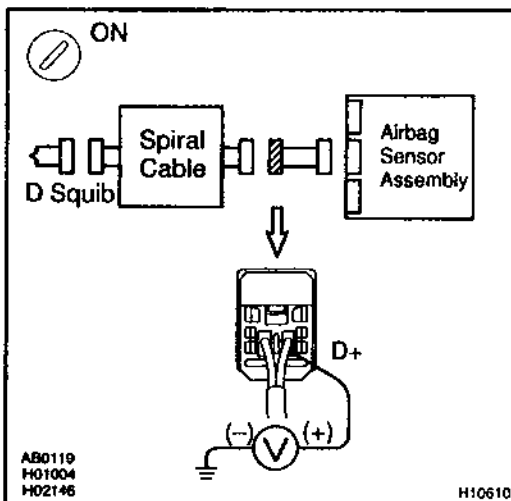
OK**6 Check harness between airbag sensor assembly and spiral cable.****CHECK:**

- Turn the ignition switch to ON.
- For the connector (on the spiral cable side) between the spiral cable and airbag sensor assembly, measure the voltage between D+ and body ground.

OK:

Voltage: 0 V

NG

Repair or replace harness between airbag sensor assembly and spiral cable.

OK

From the results of the above inspection, the malfunctioning part can now be considered normal. To make sure of this, use the simulation method to check. If the malfunctioning part can not be detected by the simulation method, replace all SRS components including the wire harness.

DTC	B0105/53	Short in P Squib Circuit
------------	-----------------	---------------------------------

CIRCUIT DESCRIPTION

The P squib circuit consists of the airbag sensor assembly and front passenger airbag assembly. It causes the SRS to deploy when the SRS deployment conditions are satisfied.

For details of the function of each component, see OPERATION on page RS-2.

DTC B0105/53 is recorded when a short is detected in the P squib circuit.

DTC No.	DTC Detecting Condition	Trouble Area
B0105/53	<ul style="list-style-type: none"> • Short circuit in P squib wire harness • P squib malfunction • Airbag sensor assembly malfunction 	<ul style="list-style-type: none"> • Front passenger airbag assembly (P squib) • Airbag sensor assembly • Wire harness

WIRING DIAGRAM

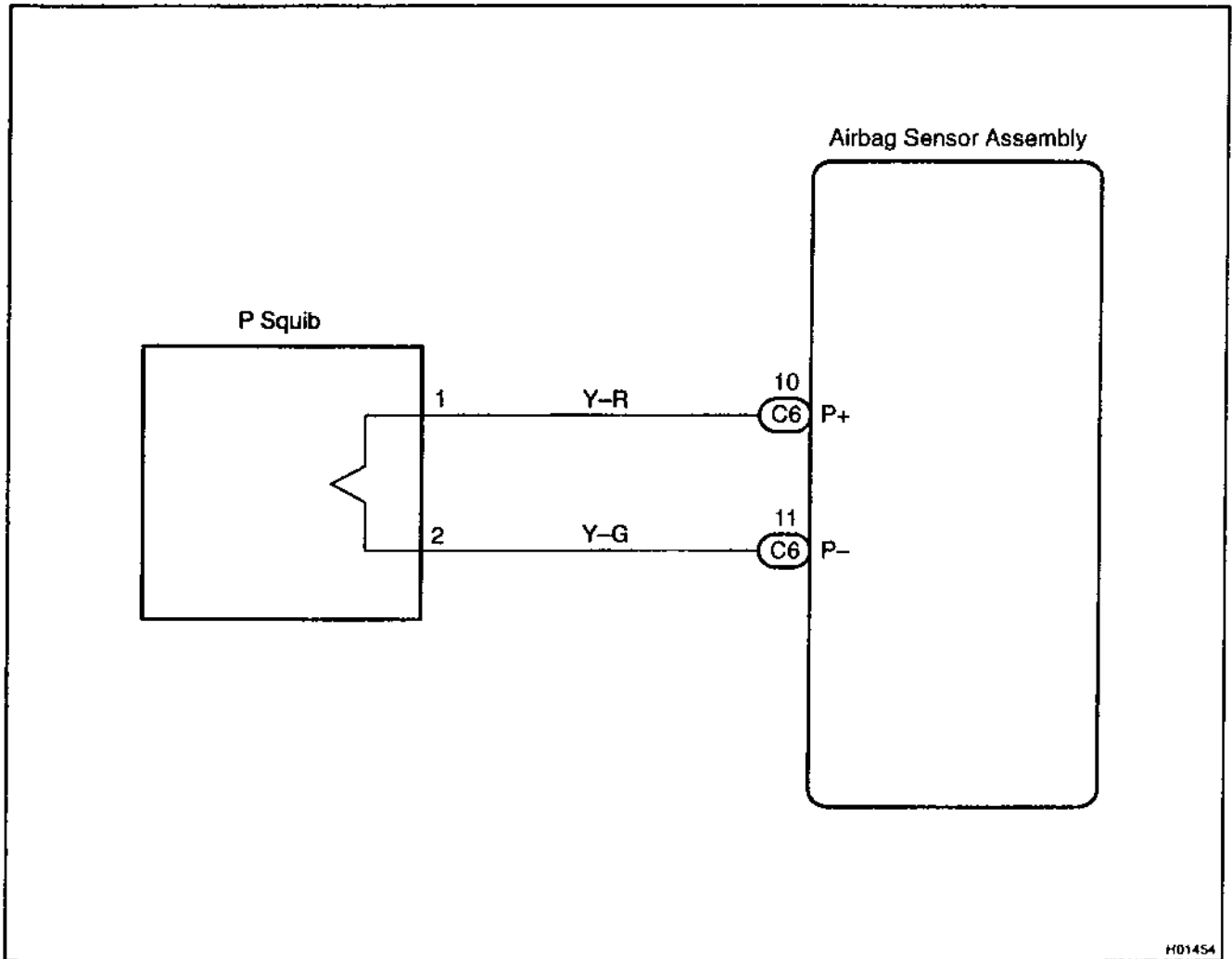

INSPECTION PROCEDURE

1 Prepare for inspection (See step 1 on page DI-471).

2 Check P squib circuit.

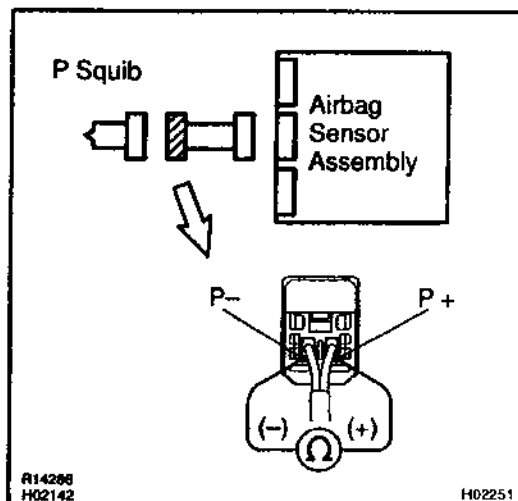
**PREPARATION:**

Release the airbag activation prevention mechanism of the connector (on the airbag sensor assembly side) between the front passenger airbag assembly and the airbag sensor assembly (See page DI-326).

CHECK:

For the connector (on the front passenger airbag assembly side) between the front passenger airbag assembly and the airbag sensor assembly, measure the resistance between P+ and P-.

OK:

Resistance: 1 MΩ or Higher

NG

Repair or replace harness or connector between front passenger airbag assembly and airbag sensor assembly.

OK

3 Check airbag sensor assembly.

P Squib

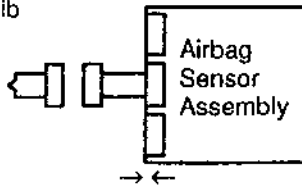

ON



DLC3

DTC B0105/53

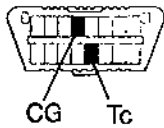

H01023
AB0119
H10600 H01077

H10611

PREPARATION:

- Connect the connector to the airbag sensor assembly.
- Connect negative (-) terminal cable to the battery, and wait at least for 2 seconds.

CHECK:

- Turn the ignition switch to ON and wait at least for 20 seconds.
- Clear the DTC stored in memory (See page DI-326).
- Turn the ignition switch to LOCK, and wait at least for 20 seconds.
- Turn the ignition switch to ON, and wait at least for 20 seconds.
- Check the DTC (See page DI-326).

OK:

DTC B0105/53 is not output.

HINT:

Codes other than code B0105/53 may be output at this time, but they are not relevant to this check.

NG

Replace airbag sensor assembly.

OK

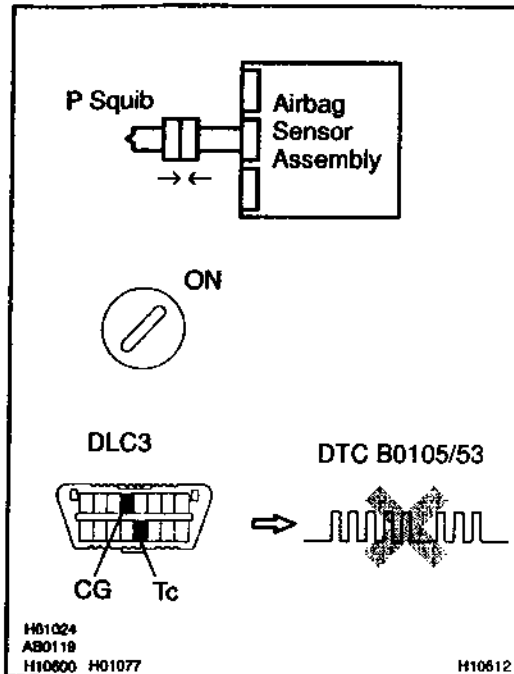
4 Check P squib.**PREPARATION:**

- Turn the ignition switch to LOCK.
- Disconnect negative (-) terminal cable from the battery, and wait at least for 90 seconds.
- Connect the front passenger airbag assembly connector.
- Connect negative (-) terminal cable to the battery, and wait at least for 2 seconds.

CHECK:

- Turn the ignition switch to LOCK, and wait at least for 20 seconds.
- Turn the ignition switch to ON, and wait at least for 20 seconds.
- Clear the DTC stored in memory (See page DI-326).
- Turn the ignition switch to LOCK, and wait at least for 20 seconds.
- Turn the ignition switch to ON, and wait at least for 20 seconds.
- Check the DTC (See page DI-326).

OK:

DTC B0105/53 is not output.

HINT:

Codes other than code B0105/53 may be output at this time, but they are not relevant to this check.

NG

Replace front passenger airbag assembly.

OK

From the results of the above inspection, the malfunctioning part can now be considered normal. To make sure of this, use the simulation method to check.

DTC	B0106/54	Open in P Squib Circuit
------------	-----------------	--------------------------------

CIRCUIT DESCRIPTION

The P squib circuit consists of the airbag sensor assembly and front passenger airbag assembly. It causes the SRS to deploy when the SRS deployment conditions are satisfied. For details of the function of each component, see OPERATION on page RS-2. DTC B0106/54 is recorded when an open is detected in the P squib circuit.

DTC No.	DTC Detecting Condition	Trouble Area
B0106/54	<ul style="list-style-type: none"> • Open circuit in P+ wire harness or P- wire harness of squib • P squib malfunction • Airbag sensor assembly malfunction 	<ul style="list-style-type: none"> • Front passenger airbag assembly (P squib) • Airbag sensor assembly • Wire harness

WIRING DIAGRAM

See page DI-356.

INSPECTION PROCEDURE

1	Prepare for inspection (See step 1 on page DI-471).
----------	------------------------------------------------------------

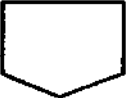

2	Check P squib circuit.
----------	-------------------------------

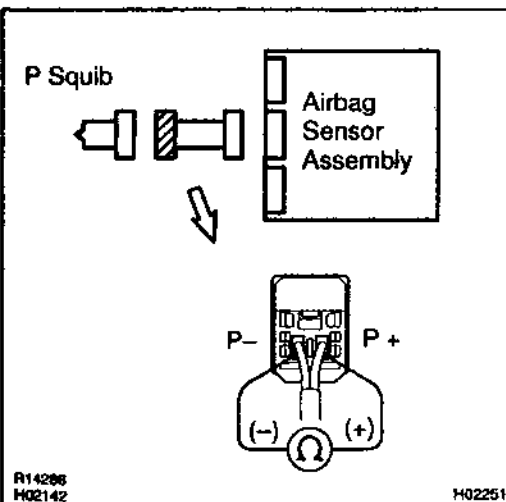

CHECK:

For the connector (on the front passenger airbag assembly side) between the front passenger airbag assembly and the airbag sensor assembly, measure the resistance between P+ and P-.

OK:

Resistance: Below 1 Ω

NG

Repair or replace harness or connector between front passenger airbag assembly and airbag sensor assembly.

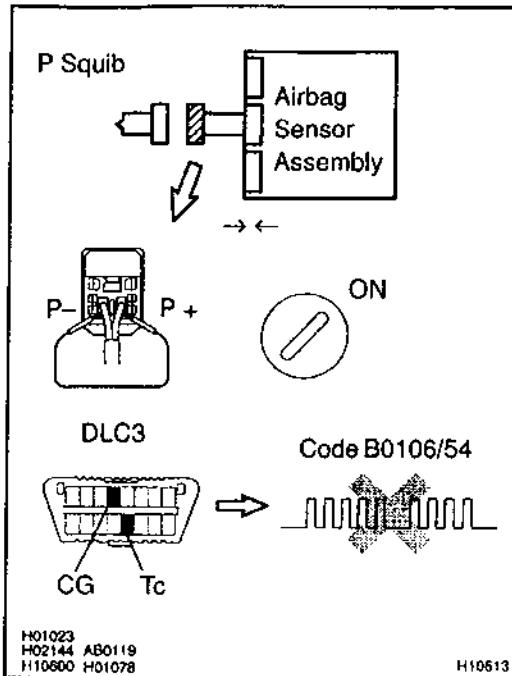

3

Check airbag sensor assembly.**PREPARATION:**

- Connect the connector to the airbag sensor assembly.
- Using a service wire, connect P+ and P- of the connector (on the front passenger airbag assembly side) between the front passenger airbag assembly and the airbag sensor assembly.
- Connect negative (-) terminal cable to the battery, and wait at least for 2 seconds.

CHECK:

- Turn the ignition switch to ON and wait at least for 20 seconds.
- Clear the DTC stored in memory (See page DI-326).
- Turn the ignition switch to LOCK, and wait at least for 20 seconds.
- Turn the ignition switch to ON, and wait at least for 20 seconds.
- Check the DTC (See page DI-326).

OK:**DTC B0106/54 is not output.****HINT:**

Codes other than code B0106/54 may be output at this time, but they are not relevant to this check.

NG**Replace airbag sensor assembly.****OK**

4

Check P squib.

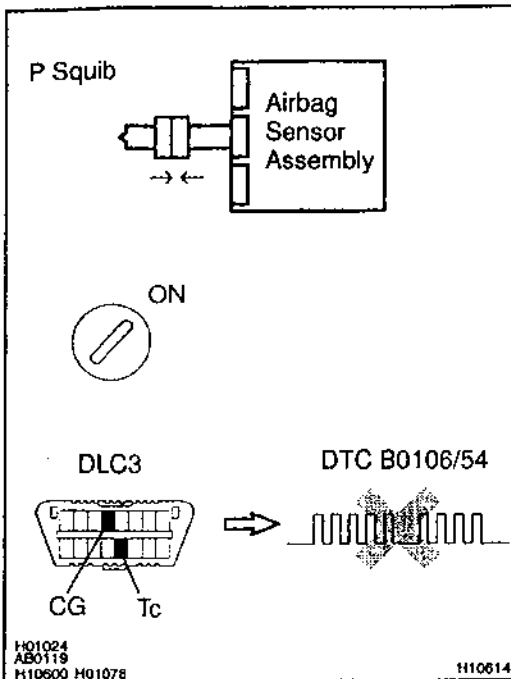
**PREPARATION:**

- Turn the ignition switch to LOCK.
- Disconnect negative (-) terminal cable from the battery, and wait at least for 90 seconds.
- Connect the front passenger airbag assembly connector.
- Connect negative (-) terminal cable to the battery, and wait at least for 2 seconds.

CHECK:

- Turn the ignition switch to ON, and wait at least for 20 seconds.
- Clear the DTC stored in memory (See page DI-326).
- Turn the ignition switch to LOCK, and wait at least for 20 seconds.
- Turn the ignition switch to ON, and wait at least for 20 seconds.
- Check the DTC (See page DI-326).

OK:

DTC B0106/54 is not output.

HINT:

Codes other than code B0106/54 may be output at this time, but they are not relevant to this check.

NG

Replace front passenger airbag assembly.

OK

From the results of the above inspection, the malfunctioning part can now be considered normal. To make sure of this, use the simulation method to check.

DMP9-01

DTC	B0107/51	Short in P Squib Circuit (to Ground)
------------	-----------------	---------------------------------------------

CIRCUIT DESCRIPTION

The P squib circuit consists of the airbag sensor assembly and front passenger airbag assembly. It causes the SRS to deploy when the SRS deployment conditions are satisfied. For details of the function of each component, see OPERATION on page RS-2. DTC B0107/51 is recorded when ground short is detected in the P squib circuit.

DTC No.	DTC Detecting Condition	Trouble Area
B0107/51	<ul style="list-style-type: none"> • Short circuit in P squib wire harness (to ground) • P squib malfunction • Airbag sensor assembly malfunction 	<ul style="list-style-type: none"> • Front passenger airbag assembly (P squib) • Airbag sensor assembly • Wire harness

WIRING DIAGRAM

See page DI-356.

INSPECTION PROCEDURE

1	Prepare for inspection (See step 1 on page DI-471).
----------	------------------------------------------------------------



2	Check P squib circuit.
----------	-------------------------------

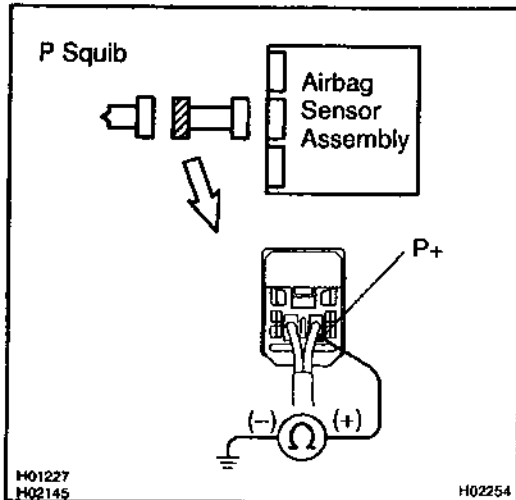

CHECK:

For the connector (on the front passenger airbag assembly side) between the front passenger airbag assembly and the airbag sensor assembly, measure the resistance between P+ and body ground.

OK:

Resistance: 1 MΩ or Higher



Repair or replace harness or connector between front passenger airbag assembly and airbag sensor assembly.



3 Check airbag sensor assembly.

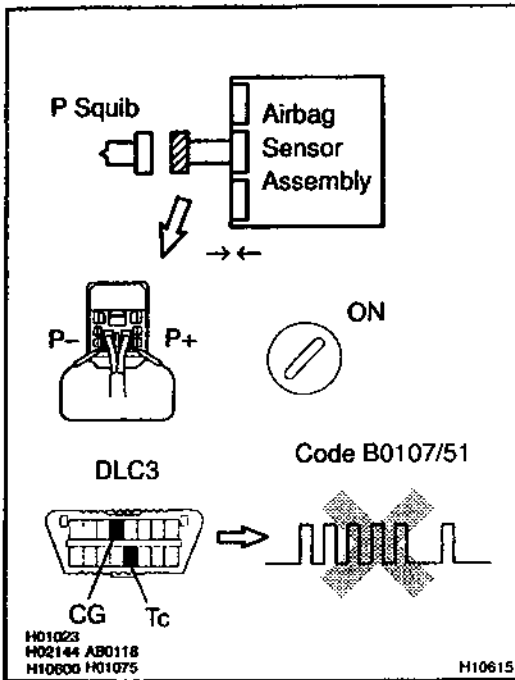

PREPARATION:

- Connect the connector to the airbag sensor assembly.
- Using a service wire, connect P+ and P- of the connector (on the front passenger airbag assembly side) between the front passenger airbag assembly and the airbag sensor assembly.
- Connect negative (-) terminal cable to the battery, and wait at least for 2 seconds.

CHECK:

- Turn the ignition switch to ON and wait at least for 20 seconds.
- Clear the DTC stored in memory (See step 5 on page DI-326).
- Turn the ignition switch to LOCK, and wait at least for 20 seconds.
- Turn the ignition switch to ON, and wait at least for 20 seconds.
- Check the DTC (See page DI-326).

OK:

DTC B0107/51 is not output.

HINT:

Codes other than code B0107/51 may be output at this time, but they are not relevant to this check.

NG

Replace airbag sensor assembly.

OK

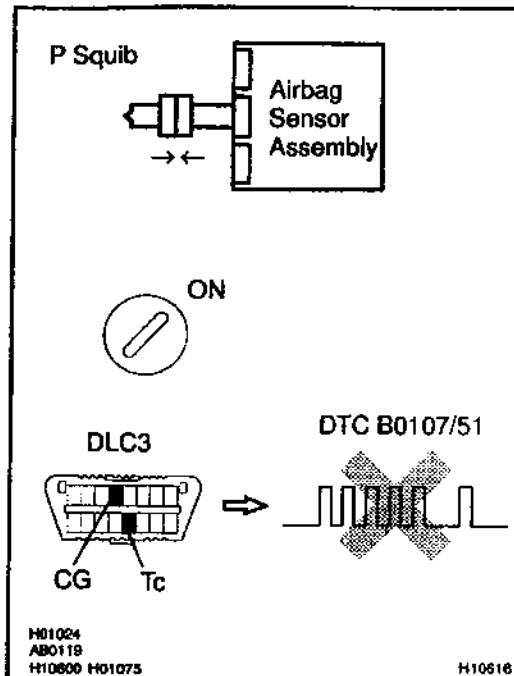
4 Check P squib.**PREPARATION:**

- Turn the ignition switch to LOCK.
- Disconnect negative (-) terminal cable from the battery, and wait at least for 90 seconds.
- Connect the front passenger airbag assembly connector.
- Connect negative (-) terminal cable to the battery, and wait at least for 2 seconds.

CHECK:

- Turn the ignition switch to ON, and wait at least for 20 seconds.
- Clear the DTC stored in memory (See step 5 on page DI-326).
- Turn the ignition switch to LOCK, and wait at least for 20 seconds.
- Turn the ignition switch to ON, and wait at least for 20 seconds.
- Check the DTC (See page DI-326).

OK:

DTC B0107/51 is not output.

HINT:

Codes other than code B0107/51 may be output at this time, but they are not relevant to this check.

NG

Replace front passenger airbag assembly.

OK

From the results of the above inspection, the malfunctioning part can now be considered normal. To make sure of this, use the simulation method to check. If the malfunctioning part can not be detected by the simulation method, replace all SRS components including the wire harness.

DTC	B0108/52	Short in P Squib Circuit (to B+)
------------	-----------------	-----------------------------------------

CIRCUIT DESCRIPTION

The P squib circuit consists of the airbag sensor assembly and front passenger airbag assembly. It causes the SRS to deploy when the SRS deployment conditions are satisfied. For details of the function of each component, see OPERATION on page RS-2. DTC B0108/52 is recorded when a B+ short is detected in the P squib circuit.

DTC No.	DTC Detecting Condition	Trouble Area
B0108/52	<ul style="list-style-type: none"> • Short circuit in P squib wire harness (to B+) • P squib malfunction • Airbag sensor assembly malfunction 	<ul style="list-style-type: none"> • Front passenger airbag assembly (P squib) • Airbag sensor assembly • Wire harness

WIRING DIAGRAM

See page DI-356.

INSPECTION PROCEDURE

1	Prepare for inspection (See step 1 on page DI-471).
----------	------------------------------------------------------------

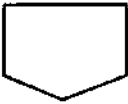

2	Check P squib circuit.
----------	-------------------------------

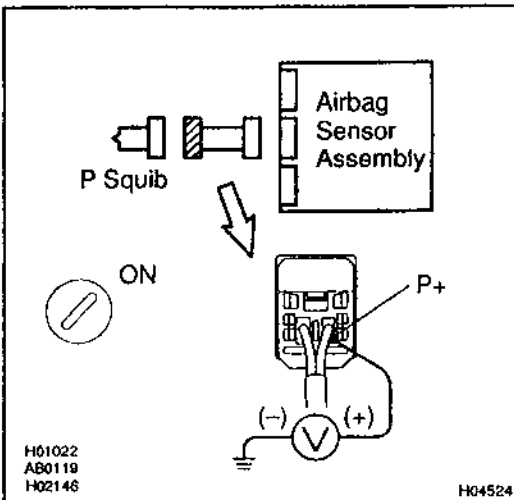

CHECK:

- (a) Turn the ignition switch to ON.
- (b) For the connector (on the front passenger airbag assembly side) between the front passenger airbag assembly and the airbag sensor assembly, measure the voltage between the P+ and body ground.

OK:

Voltage: 0 V

NG

Repair or replace harness or connector between front passenger airbag assembly and airbag sensor assembly.

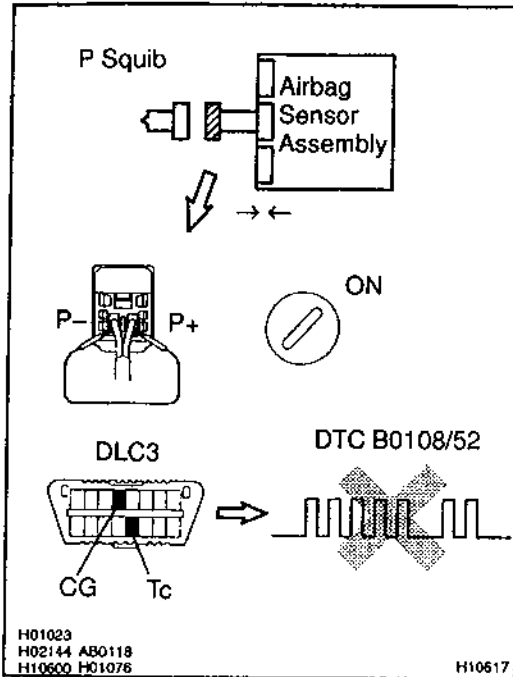

3 Check airbag sensor assembly.**PREPARATION:**

- Connect the connector to the airbag sensor assembly.
- Using a service wire, connect P+ and P- of the connector (on the front passenger airbag assembly side) between the front passenger airbag assembly and the airbag sensor assembly.
- Connect negative (-) terminal cable to the battery, and wait at least for 2 seconds.

CHECK:

- Turn the ignition switch to ON and wait at least for 20 seconds.
- Clear the DTC stored in memory (See step 5 on page DI-326).
- Turn the ignition switch to LOCK, and wait at least for 20 seconds.
- Turn the ignition switch to ON, and wait at least for 20 seconds.
- Check the DTC (See page DI-326).

OK:

DTC B0108/52 is not output.

HINT:

Codes other than code B0108/52 may be output at this time, but they are not relevant to this check.

NG

Replace airbag sensor assembly.

OK

4

Check P squib.

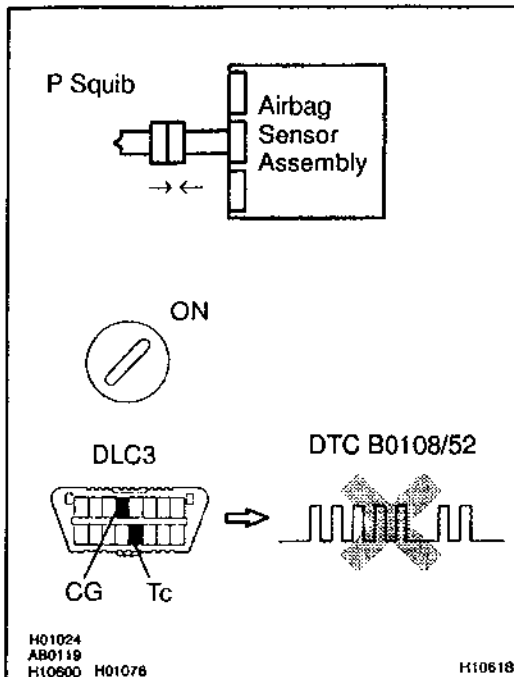
**PREPARATION:**

- Turn the ignition switch to LOCK.
- Disconnect negative (-) terminal cable from the battery, and wait at least for 90 seconds.
- Connect the front passenger airbag assembly connector.
- Connect negative (-) terminal cable to the battery, and wait at least for 2 seconds.

CHECK:

- Turn the ignition switch to ON, and wait at least for 20 seconds.
- Clear the DTC stored in memory (See step 5 on page DI-326).
- Turn the ignition switch to LOCK, and wait at least for 20 seconds.
- Turn the ignition switch to ON, and wait at least for 20 seconds.
- Check the DTC (See page DI-326).

OK:

DTC B0108/52 is not output.

HINT:

Codes other than code B0108/52 may be output at this time, but they are not relevant to this check.

NG

Replace front passenger airbag assembly.

OK

From the results of the above inspection, the malfunctioning part can now be considered normal. To make sure of this, use the simulation method to check. If the malfunctioning part can not be detected by the simulation method, replace all SRS components including the wire harness.

DTC	B0110/43	Short in Side Squib (RH) Circuit
------------	-----------------	-----------------------------------------

CIRCUIT DESCRIPTION

The side squib (RH) circuit consists of the airbag sensor assembly and side airbag assembly (RH). It causes the SRS to deploy when the SRS deployment conditions are satisfied.

For details of the function of each component, see OPERATION on page RS-2.

DTC B0110/43 is recorded when a short is detected in the side squib (RH) circuit.

DTC No.	DTC Detecting Condition	Trouble Area
B0110/43	<ul style="list-style-type: none"> • Short circuit between FR+ wire harness and FR- wire harness of squib • Side squib (RH) malfunction • Airbag sensor assembly malfunction 	<ul style="list-style-type: none"> • Side airbag assembly (RH) • Airbag sensor assembly • Wire harness

WIRING DIAGRAM

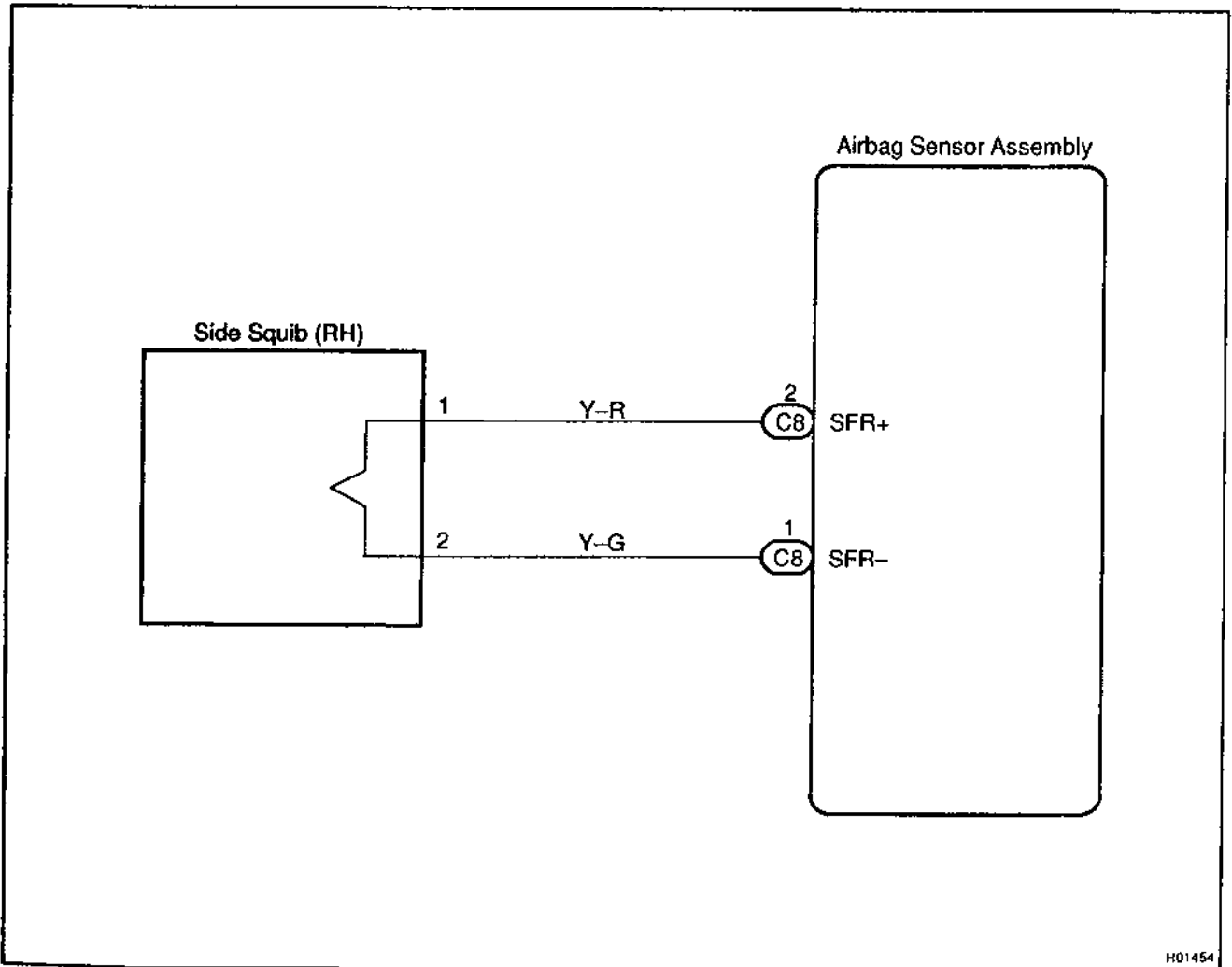

INSPECTION PROCEDURE

1 Prepare for inspection (See step 1 on page DI-471).

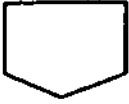

2 Check side squib (RH) circuit.

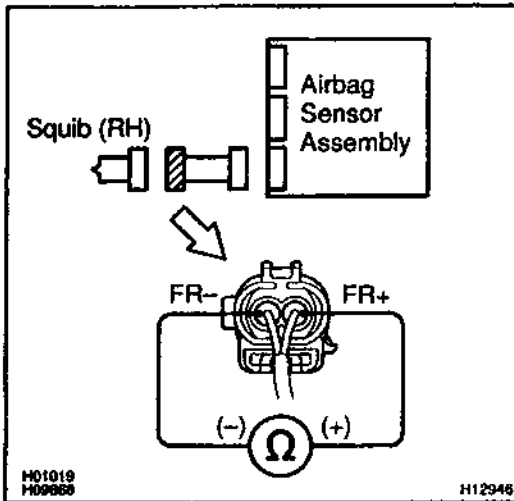
**PREPARATION:**

Release the airbag activation prevention mechanism of the connector (on the airbag sensor assembly side) between the airbag sensor assembly and the side airbag assembly (RH) (See page DI-326).

CHECK:

For the connector (on the side airbag assembly side) between the side airbag assembly (RH) and the airbag sensor assembly, measure the resistance between FR+ and FR-.

OK:

Resistance: 1 MΩ or Higher

NG

Repair or replace harness or connector between side airbag assembly (RH) and airbag sensor assembly.

OK

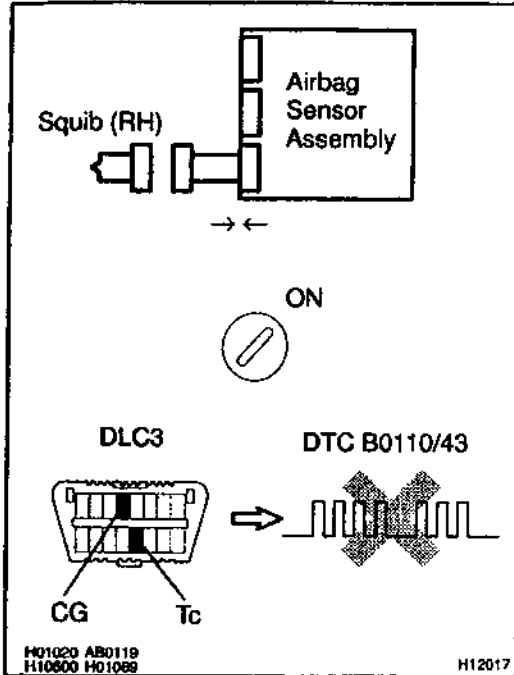
3 Check airbag sensor assembly.**PREPARATION:**

- (a) Connect the connector to the airbag sensor assembly.
- (b) Connect negative (-) terminal cable to the battery, and wait at least for 2 seconds.

CHECK:

- (a) Turn the ignition switch to ON and wait at least for 20 seconds.
- (b) Clear the DTC stored in memory (See page DI-326).
- (c) Turn the ignition switch to LOCK, and wait at least for 20 seconds.
- (d) Turn the ignition switch or ON, and wait at least for 20 seconds.
- (e) Check the DTC (See page DI-326).

OK:

DTC B0110/43 is not output.

HINT:

Codes other than code B0110/43 may be output at this time, but they are not relevant to this check.

NG

Replace airbag sensor assembly.

OK

4 Check side squib (RH).

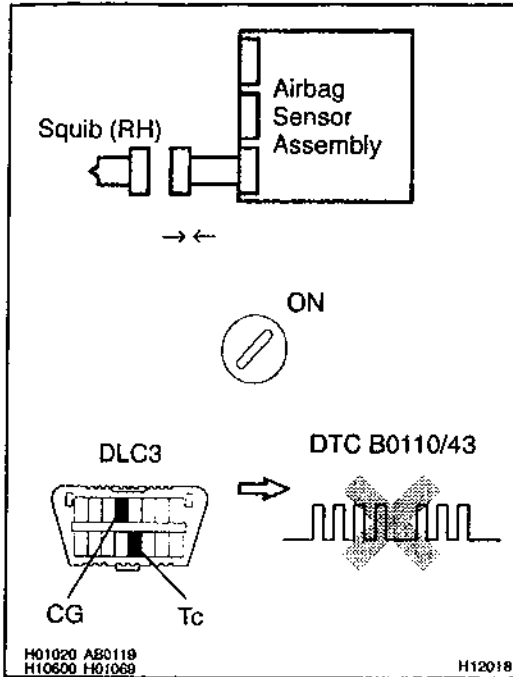

PREPARATION:

- Turn the ignition switch to LOCK.
- Disconnect negative (-) terminal cable from the battery, and wait at least for 90 seconds.
- Connect the side airbag assembly (RH) connector.
- Connect negative (-) terminal cable to the battery, and wait at least for 2 seconds.

CHECK:

- Turn the ignition switch to LOCK, and wait at least for 20 second.
- Turn the ignition switch to ON, and wait at least for 20 seconds.
- Clear the DTC stored in memory (See page DI-326).
- Turn the ignition switch to LOCK, and wait at least for 20 seconds.
- Turn the ignition switch to ON, and wait at least for 20 seconds.
- Check the DTC (See page DI-326).

OK:

DTC B0110/43 is not output.

HINT:

Codes other than code B0110/43 may be output at this time, but they are not relevant to this check.

NG

Replace side airbag assembly (RH).

OK

From the results of the above inspection, the malfunctioning part can now be considered normal. To make sure of this, use the simulation method to check.

DTC	B0111/44	Open in Side Squib (RH) Circuit
------------	-----------------	----------------------------------------

CIRCUIT DESCRIPTION

The side squib (RH) circuit consists of the airbag sensor assembly and side airbag assembly (RH). It causes the SRS to deploy when the SRS deployment conditions are satisfied. For details of the function of each component, see OPERATION on page RS-2. DTC B0111/44 is recorded when an open is detected in the side squib (RH) circuit.

DTC No.	DTC Detecting Condition	Trouble Area
B0111/44	<ul style="list-style-type: none"> • Open circuit in FR+ wire harness or FR- wire harness of squib • Side squib (RH) malfunction • Airbag sensor assembly malfunction 	<ul style="list-style-type: none"> • Side airbag assembly (RH) • Airbag sensor assembly • Wire harness

WIRING DIAGRAM

See page DI-369.

INSPECTION PROCEDURE

1	Prepare for inspection (See step 1 on page DI-471).
----------	------------------------------------------------------------

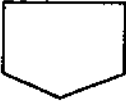

2	Check front side squib (RH) circuit.
----------	---------------------------------------------

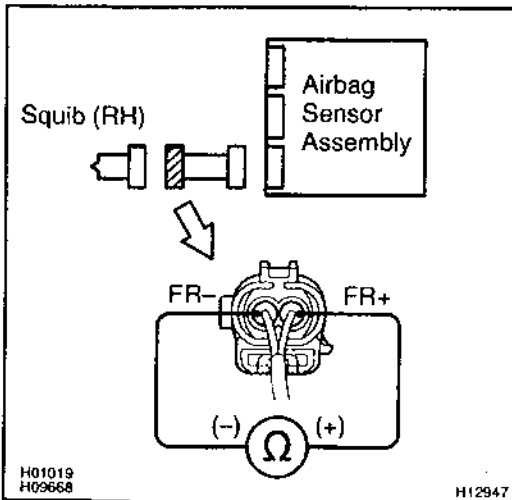

CHECK:

For the connector (on the front side airbag assembly side) between the front side airbag assembly (RH) and the airbag sensor assembly, measure the resistance between FR+ and FR-.

OK:

Resistance: Below 1 Ω



Repair or replace harness or connector between side airbag assembly (RH) and airbag sensor assembly.



3 Check airbag sensor assembly.

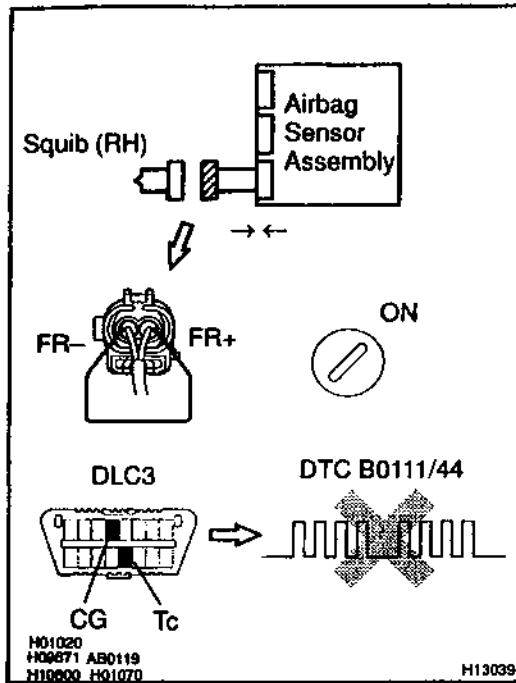

PREPARATION:

- Connect the connector to the airbag sensor assembly.
- Using a service wire, connect FR+ and FR- of the connector (on the side airbag assembly side) between the side airbag assembly (RH) and the airbag sensor assembly.
- Connect negative (-) terminal cable to the battery, and wait at least for 2 seconds.

CHECK:

- Turn the ignition switch to ON and wait at least for 20 seconds.
- Clear the DTC stored in memory (See page DI-326).
- Turn the ignition switch to LOCK, and wait at least for 20 seconds.
- Turn the ignition switch to ON, and wait at least for 20 seconds.
- Check the DTC (See page DI-326).

OK:

DTC B0111/44 is not output.

HINT:

Codes other than code B0111/44 may be output at this time, but they are not relevant to this check.

NG

Replace airbag sensor assembly.

OK

4 Check side squib (RH).

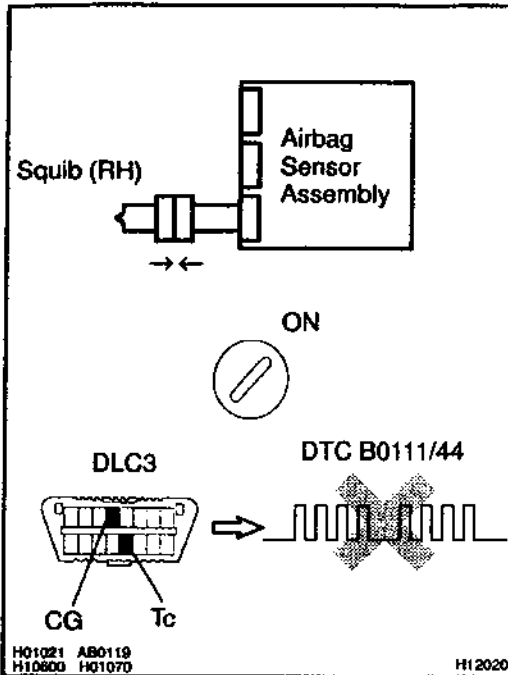

PREPARATION:

- Turn the ignition switch to LOCK.
- Disconnect negative (-) terminal cable from the battery, and wait at least for 90 seconds.
- Connect the front side airbag assembly (RH) connector.
- Connect negative (-) terminal cable to the battery, and wait at least for 2 seconds.

CHECK:

- Turn the ignition switch to ON, and wait at least for 20 seconds.
- Clear the DTC stored in memory (See page DI-326).
- Turn the ignition switch to LOCK, and wait at least for 20 seconds.
- Turn the ignition switch to ON, and wait at least for 20 seconds.
- Check the DTC (See page DI-326).

OK:

DTC B0111/44 is not output.

HINT:

Codes other than code B0111/44 may be output at this time, but they are not relevant to this check.

NG

Replace side airbag assembly (RH).

OK

From the results of the above inspection, the malfunctioning part can now be considered normal. To make sure of this, use the simulation method to check.

DTC	B0112/41	Short in Side Squib (RH) Circuit (to Ground)
------------	-----------------	-----------------------------------------------------

CIRCUIT DESCRIPTION

The side squib (RH) circuit consists of the airbag sensor assembly and side airbag assembly (RH). It causes the SRS to deploy when the SRS deployment conditions are satisfied. For details of the function of each component, see OPERATION on page RS-2. DTC B0112/41 is recorded when ground short is detected in the side squib (RH) circuit.

DTC No.	DTC Detecting Condition	Trouble Area
B0112/41	<ul style="list-style-type: none"> • Short circuit in side squib (RH) wire harness (to ground) • Side squib (RH) malfunction • Airbag sensor assembly malfunction 	<ul style="list-style-type: none"> • Side airbag assembly (RH) • Airbag sensor assembly • Wire harness

WIRING DIAGRAM

See page DI-369.

INSPECTION PROCEDURE

1	Prepare for inspection (See step 1 on page DI-471).
----------	------------------------------------------------------------

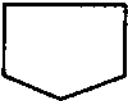

2	Check side squib (RH) circuit.
----------	---------------------------------------

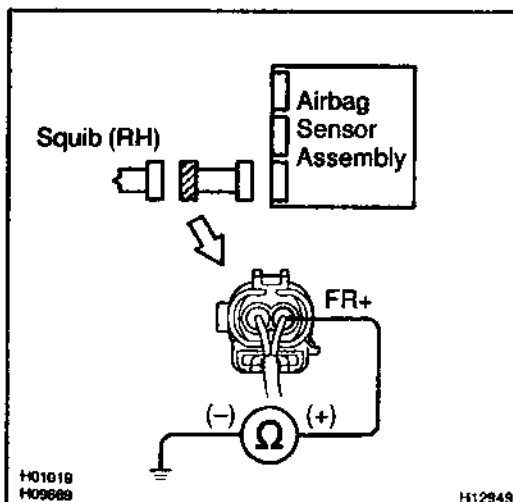

CHECK:

For the connector (on the side airbag assembly side) between the side airbag assembly (RH) and the airbag sensor assembly, measure the resistance between FR+ and body ground.

OK:

Resistance: 1 MΩ or Higher



Repair or replace harness or connector between side airbag assembly (RH) and airbag sensor assembly.



3 Check airbag sensor assembly.

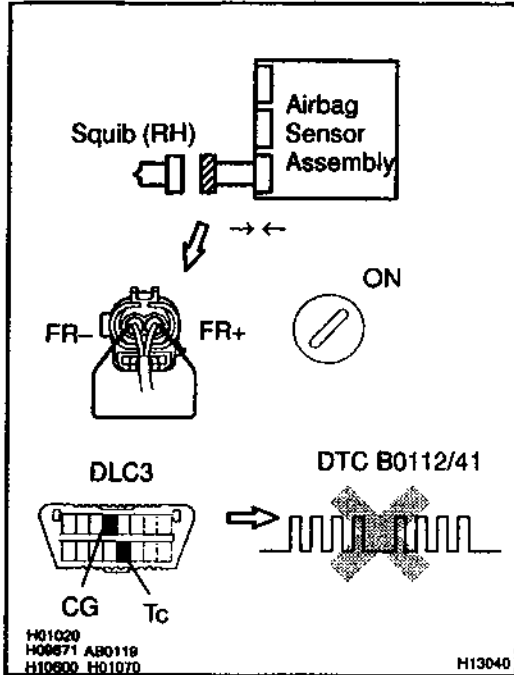

PREPARATION:

- Connect the connector to the airbag sensor assembly.
- Using a service wire, connect FR+ and FR- of the connector (on the side airbag assembly side) between the side airbag assembly (RH) and the airbag sensor assembly.
- Connect negative (-) terminal cable to the battery, and wait at least for 2 seconds.

CHECK:

- Turn the ignition switch to ON and wait at least for 20 seconds.
- Clear the DTC stored in memory (See step 5 on page DI-326).
- Turn the ignition switch to LOCK, and wait at least for 20 seconds.
- Turn the ignition switch to ON, and wait at least for 20 seconds.
- Check the DTC (See page DI-326).

OK:

DTC B0112/41 is not output.

HINT:

Codes other than code B0112/41 may be output at this time, but they are not relevant to this check.

NG

Replace airbag sensor assembly.

OK

4 Check side squib (RH).

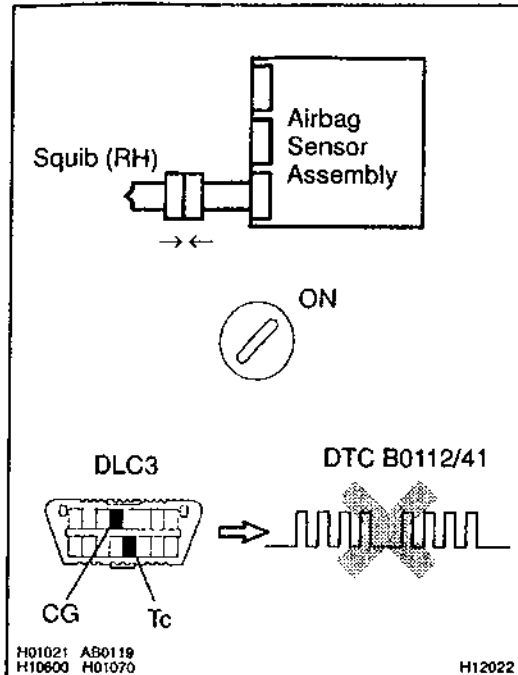

PREPARATION:

- Turn the ignition switch to LOCK.
- Disconnect negative (-) terminal cable from the battery, and wait at least for 90 seconds.
- Connect the side airbag assembly (RH) connector.
- Connect negative (-) terminal cable to the battery, and wait at least for 2 seconds.

CHECK:

- Turn the ignition switch to ON, and wait at least for 20 seconds.
- Clear the DTC stored in memory (See step 5 on page DI-326).
- Turn the ignition switch to LOCK, and wait at least for 20 seconds.
- Turn the ignition switch to ON, and wait at least for 20 seconds.
- Check the DTC (See page DI-326).

OK:

DTC B0112/41 is not output.

HINT:

Codes other than code B0112/41 may be output at this time, but they are not relevant to this check.

NG

Replace side airbag assembly (RH).

OK

From the results of the above inspection, the malfunctioning part can now be considered normal. To make sure of this, use the simulation method to check. If the malfunctioning part can not be detected by the simulation method, replace all SRS components including the wire harness.

DTC	B0113/42	Short in Side Squib (RH) Circuit (to B+)
------------	-----------------	-------------------------------------------------

CIRCUIT DESCRIPTION

The side squib (RH) circuit consists of the airbag sensor assembly and side airbag assembly (RH). It causes the SRS to deploy when the SRS deployment conditions are satisfied. For details of the function of each component, see OPERATION on page RS-2. DTC B0113/42 is recorded when a B+ short is detected in the side squib (RH) circuit.

DTC No.	DTC Detecting Condition	Trouble Area
B0113/42	<ul style="list-style-type: none"> • Short circuit in side squib (RH) wire harness (to B+) • Side squib (RH) malfunction • Airbag sensor assembly malfunction 	<ul style="list-style-type: none"> • Side airbag assembly (RH) • Airbag sensor assembly • Wire harness

WIRING DIAGRAM

See page DI-369.

INSPECTION PROCEDURE

1	Prepare for inspection (See step 1 on page DI-326).
----------	------------------------------------------------------------

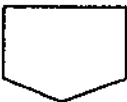

2	Check side squib (RH) circuit.
----------	---------------------------------------

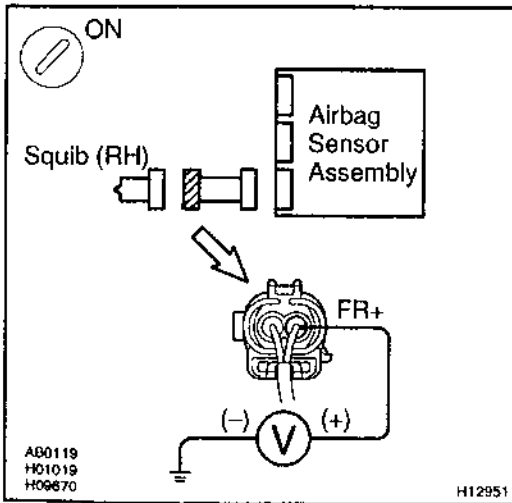

CHECK:

- (a) Turn the ignition switch to ON.
- (b) For the connector (on the airbag sensor assembly side) between the side airbag assembly (RH) and the airbag sensor assembly, measure the voltage between FR+ and body ground.

OK:

Voltage: 0 V

NG → **Repair or replace harness or connector between side airbag assembly (RH) and airbag sensor assembly.**



3 Check airbag sensor assembly.

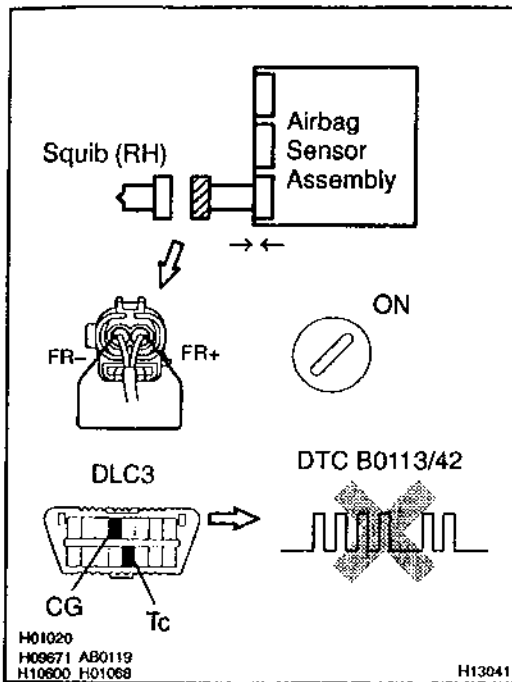

PREPARATION:

- Connect the connector to the airbag sensor assembly.
- Using a service wire, connect FR+ and FR- of the connector (on the front side airbag assembly side) between the front side airbag assembly (RH) and the airbag sensor assembly.
- Connect negative (-) terminal cable to the battery, and wait at least for 2 seconds.

CHECK:

- Turn the ignition switch to ON and wait at least for 20 seconds.
- Clear the DTC stored in memory (See step 5 on page DI-326).
- Turn the ignition switch to LOCK, and wait at least for 20 seconds.
- Turn the ignition switch to ON, and wait at least for 20 seconds.
- Check the DTC (See page DI-326).

OK:

DTC B0113/42 is not output.

HINT:

Codes other than code B0113/42 may be output at this time, but they are not relevant to this check.

NG

Replace airbag sensor assembly.

OK

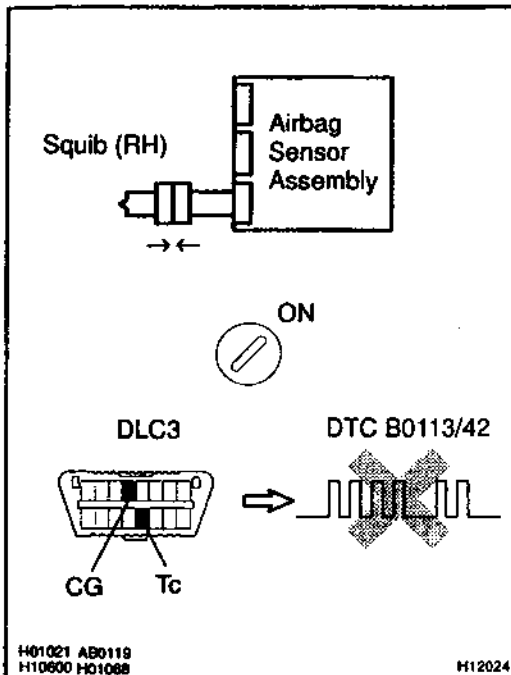
4 Check side squib (RH).**PREPARATION:**

- Turn the ignition switch to LOCK.
- Disconnect negative (-) terminal cable from the battery, and wait at least for 90 seconds.
- Connect the front side airbag assembly (RH) connector.
- Connect negative (-) terminal cable to the battery, and wait at least for 2 seconds.

CHECK:

- Turn the ignition switch to ON, and wait at least for 20 seconds.
- Clear the DTC stored in memory (See step 5 on page DI-326).
- Turn the ignition switch to LOCK, and wait at least for 20 seconds.
- Turn the ignition switch to ON, and wait at least for 20 seconds.
- Check the DTC (See page DI-326).

OK:

DTC B0113/42 is not output.

HINT:

Codes other than code B0113/42 may be output at this time, but they are not relevant to this check.

NG

Replace side airbag assembly (RH).

OK

From the results of the above inspection, the malfunctioning part can now be considered normal. To make sure of this, use the simulation method to check. If the malfunctioning part can not be detected by the simulation method, replace all SRS components including the wire harness.

DTC	B0115/47	Short In Side Squib (LH) Circuit
------------	-----------------	-----------------------------------------

CIRCUIT DESCRIPTION

The side squib (LH) circuit consists of the airbag sensor assembly and side airbag assembly (LH). It causes the SRS to deploy when the SRS deployment conditions are satisfied. For details of the function of each component, see OPERATION on page RS-2. DTC B0115/47 is recorded when a short is detected in the side squib (LH) circuit.

DTC No.	DTC Detecting Condition	Trouble Area
B0115/47	<ul style="list-style-type: none"> • Short circuit between FL+ wire harness and FL- wire harness of squib • Side squib (LH) malfunction • Airbag sensor assembly malfunction 	<ul style="list-style-type: none"> • Side airbag assembly (LH) • Airbag sensor assembly • Wire harness

WIRING DIAGRAM

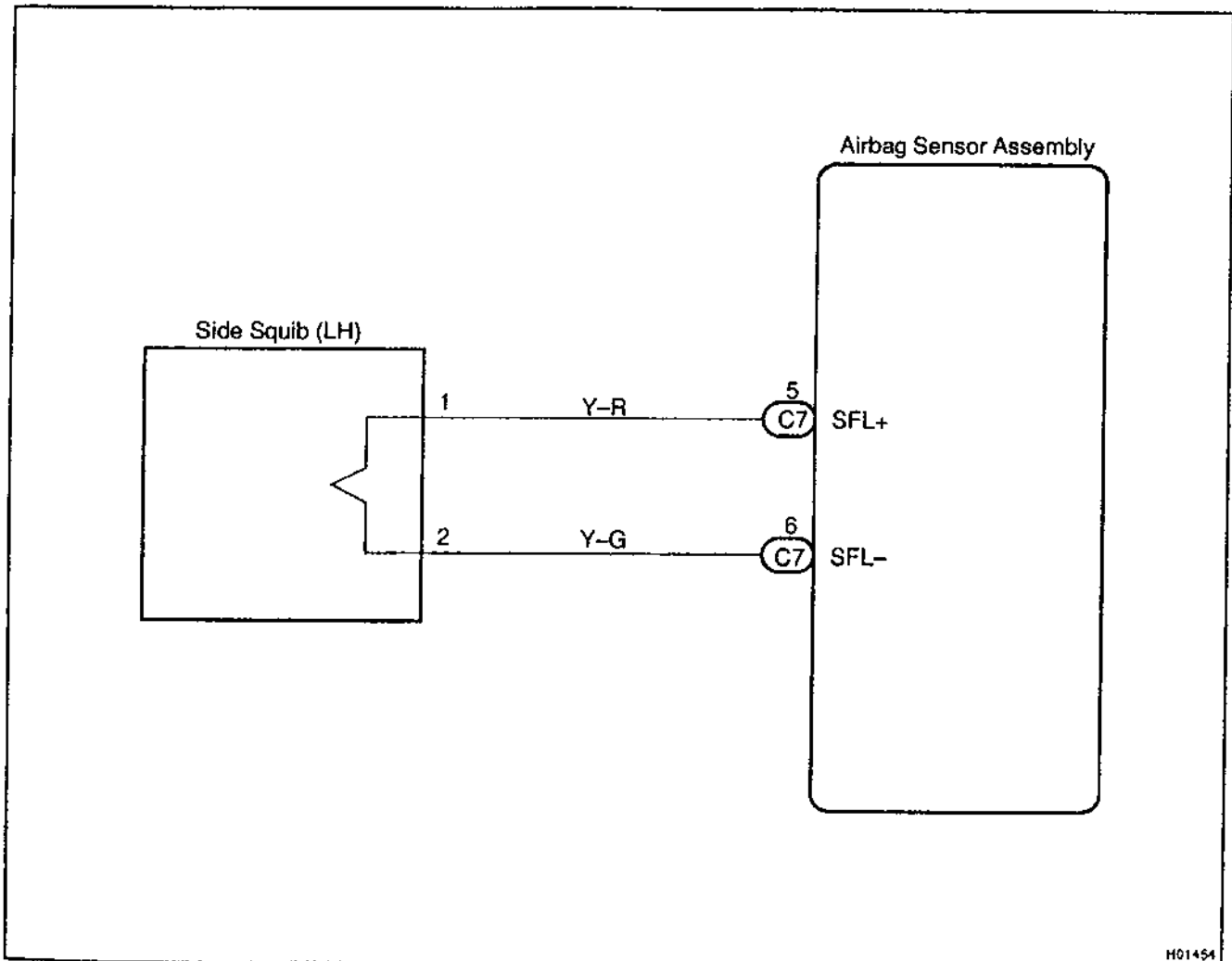

INSPECTION PROCEDURE

1 Prepare for inspection (See step 1 on page DI-471).

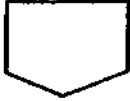

2 Check side squib (LH) circuit.

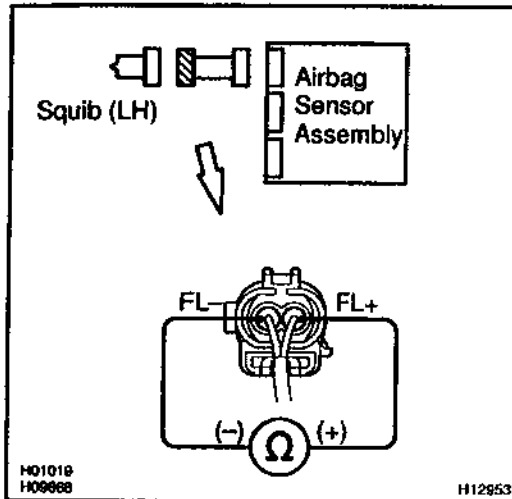
**PREPARATION:**

Release the airbag activation prevention mechanism of the connector (on the airbag sensor assembly side) between the airbag sensor assembly and the side airbag assembly (LH) (See page DI-326).

CHECK:

For the connector (on the side airbag assembly side) between the side airbag assembly (LH) and the airbag sensor assembly, measure the resistance between FL+ and FL-.

OK:

Resistance: 1 MΩ or Higher

NG

Repair or replace harness or connector between side airbag assembly (LH) and airbag sensor assembly.

OK

3 Check airbag sensor assembly.

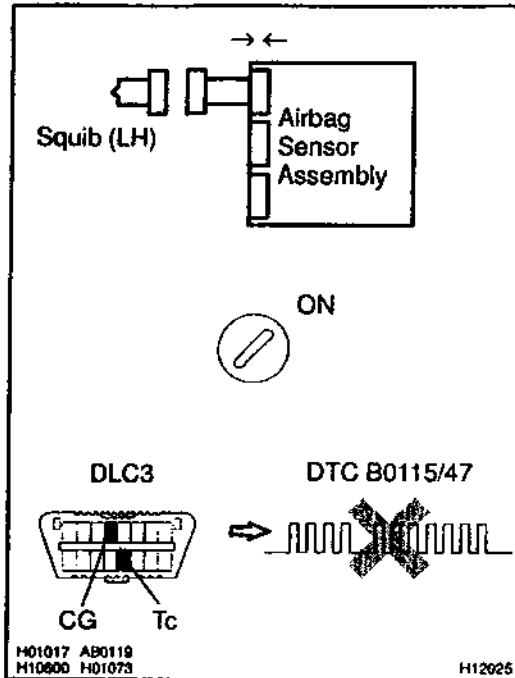

PREPARATION:

- Connect the connector to the airbag sensor assembly.
- Connect negative (-) terminal cable to the battery, and wait at least for 2 seconds.

CHECK:

- Turn the ignition switch to ON and wait at least for 20 seconds.
- Clear the DTC stored in memory (See page DI-326).
- Turn the ignition switch to LOCK, and wait at least for 20 seconds.
- Turn the ignition switch or ON, and wait at least for 20 seconds.
- Check the DTC (See page DI-326).

OK:

DTC B0115/47 is not output.

HINT:

Codes other than code B0115/47 may be output at this time, but they are not relevant to this check.

NG

Replace airbag sensor assembly.

OK

4 Check side squib (LH).

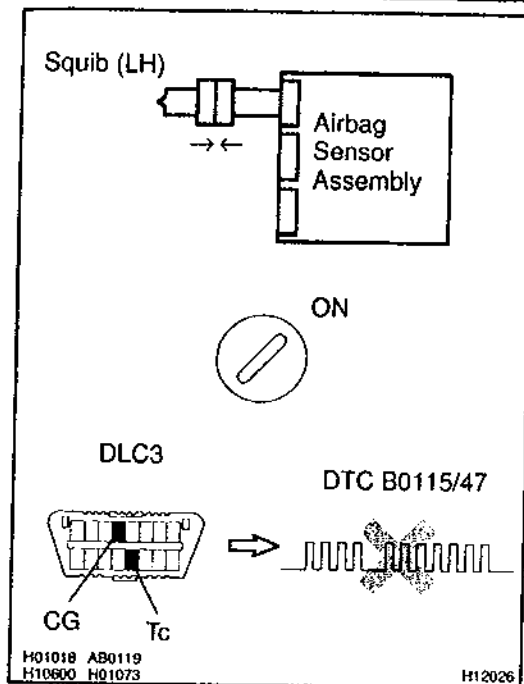

PREPARATION:

- Turn the ignition switch to LOCK.
- Disconnect negative (-) terminal cable from the battery, and wait at least for 90 seconds.
- Connect the front side airbag assembly (LH) connector.
- Connect negative (-) terminal cable to the battery, and wait at least for 2 seconds.

CHECK:

- Turn the ignition switch to LOCK, and wait at least for 20 second.
- Turn the ignition switch to ON, and wait at least for 20 seconds.
- Clear the DTC stored in memory (See page DI-326).
- Turn the ignition switch to LOCK, and wait at least for 20 seconds.
- Turn the ignition switch to ON, and wait at least for 20 seconds.
- Check the DTC (See page DI-326).

OK:

DTC B0115/47 is not output.

HINT:

Codes other than code B0115/47 may be output at this time, but they are not relevant to this check.

NG

Replace side airbag assembly (LH).

OK

From the results of the above inspection, the malfunctioning part can now be considered normal. To make sure of this, use the simulation method to check.

DTC	B0116/48	Open in Side Squib (LH) Circuit
------------	-----------------	----------------------------------------

CIRCUIT DESCRIPTION

The side squib (LH) circuit consists of the airbag sensor assembly and side airbag assembly (LH).

It causes the SRS to deploy when the SRS deployment conditions are satisfied.

For details of the function of each component, see OPERATION on page RS-2.

DTC B0116/48 is recorded when an open is detected in the side squib (LH) circuit.

DTC No.	DTC Detecting Condition	Trouble Area
B0116/48	<ul style="list-style-type: none"> • Open circuit in FL+ wire harness or FL- wire harness of squib • Side squib (LH) malfunction • Airbag sensor assembly malfunction 	<ul style="list-style-type: none"> • Side airbag assembly (LH) • Airbag sensor assembly • Wire harness

WIRING DIAGRAM

See page DI-382.

INSPECTION PROCEDURE

1	Prepare for inspection. (See step 1 on page DI-471)
----------	------------------------------------------------------------

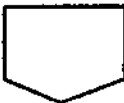

2	Check side squib (LH) circuit.
----------	---------------------------------------

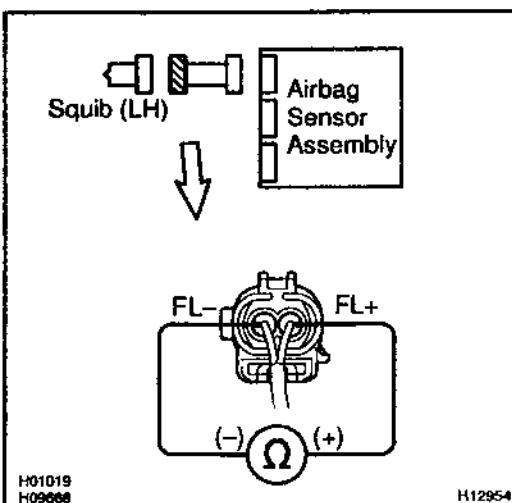

CHECK:

For the connector (on the front side airbag assembly side) between the front side airbag assembly (LH) and the airbag sensor assembly, measure the resistance between FL+ and FL-.

OK:

Resistance: Below 1 Ω

NG

Repair or replace harness or connector between side airbag assembly (LH) and airbag sensor assembly.



3 Check airbag sensor assembly.

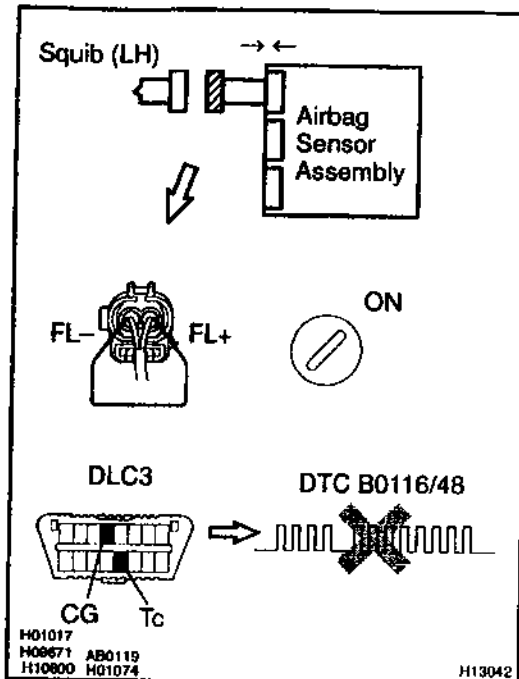

PREPARATION:

- Connect the connector to the airbag sensor assembly.
- Using a service wire, connect FL+ and FL- of the connector (on the side airbag assembly side) between the side airbag assembly (LH) and the airbag sensor assembly.
- Connect negative (-) terminal cable to the battery, and wait at least 2 seconds.

CHECK:

- Turn the ignition switch to ON and wait at least for 20 seconds.
- Clear the DTC stored in memory (See page DI-326).
- Turn the ignition switch to LOCK, and wait at least for 20 seconds.
- Turn the ignition switch to ON, and wait at least for 20 seconds.
- Check the DTC (See page DI-326).

OK:

DTC B0116/48 is not output.

HINT:

Codes other than code B0116/48 may be output at this time, but they are not relevant to this check.

NG

Replace side airbag sensor assembly.

OK

4 Check side squib (LH).

Squib (LH)

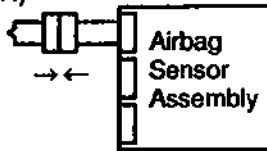

DLC3

DTC B0116/48

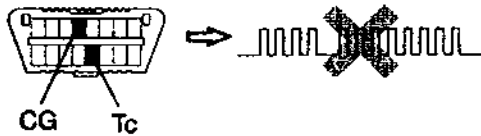
H01018 AB0118
H10800 H01074

H12028

PREPARATION:

- Turn the ignition switch to LOCK.
- Disconnect negative (-) terminal cable from the battery, and wait at least for 90 seconds.
- Connect the side airbag assembly (LH) connector.
- Connect negative (-) terminal cable to the battery, and wait at least for 2 seconds.

CHECK:

- Turn the ignition switch to ON, and wait at least for 20 seconds.
- Clear the DTC stored in memory (See page DI-326).
- Turn the ignition switch to LOCK, and wait at least for 20 seconds.
- Turn the ignition switch to ON, and wait at least for 20 seconds.
- Check the DTC (See page DI-326).

OK:**DTC B0116/48 is not output.****HINT:**

Codes other than code B0116/48 may be output at this time, but they are not relevant to this check.

NG**Replace side airbag assembly (LH).****OK**

From the results of the above inspection, the malfunctioning part can now be considered normal. To make sure of this, use the simulation method to check.

DTC	B0117/45	Short in Side Squib (LH) Circuit (to Ground)
------------	-----------------	-----------------------------------------------------

CIRCUIT DESCRIPTION

The side squib (LH) circuit consists of the airbag sensor assembly and side airbag assembly (LH). It causes the SRS to deploy when the SRS deployment conditions are satisfied. For details of the function of each component, see OPERATION on page RS-2. DTC B0117/45 is recorded when ground short is detected in the side squib (LH) circuit.

DTC No.	DTC Detecting Condition	Trouble Area
B0117/45	<ul style="list-style-type: none"> • Short circuit in side squib (LH) wire harness (to ground) • Side squib (LH) malfunction • Airbag sensor assembly malfunction 	<ul style="list-style-type: none"> • Side airbag assembly (LH) • Airbag sensor assembly • Wire harness

WIRING DIAGRAM

See page DI-382.

INSPECTION PROCEDURE

1	Prepare for inspection (See step 1 on page DI-471).
----------	------------------------------------------------------------

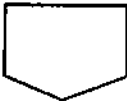

2	Check side squib (LH) circuit.
----------	---------------------------------------

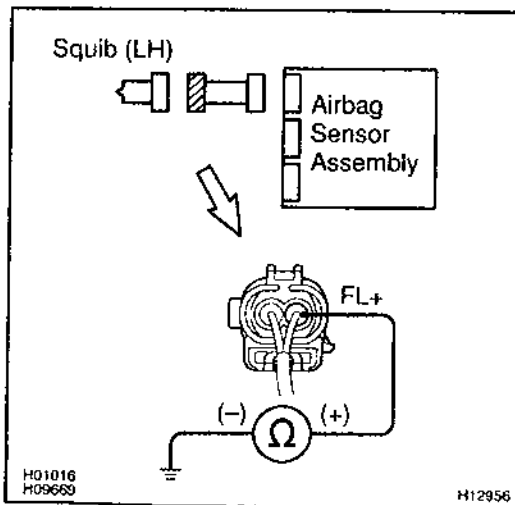

CHECK:

For the connector (on the side airbag assembly side) between the side airbag assembly (LH) and the airbag sensor assembly, measure the resistance between FL+ and body ground.

OK:

Resistance: 1 MΩ or Higher



Repair or replace harness or connector between side airbag assembly (LH) and airbag sensor assembly.



3 Check airbag sensor assembly.

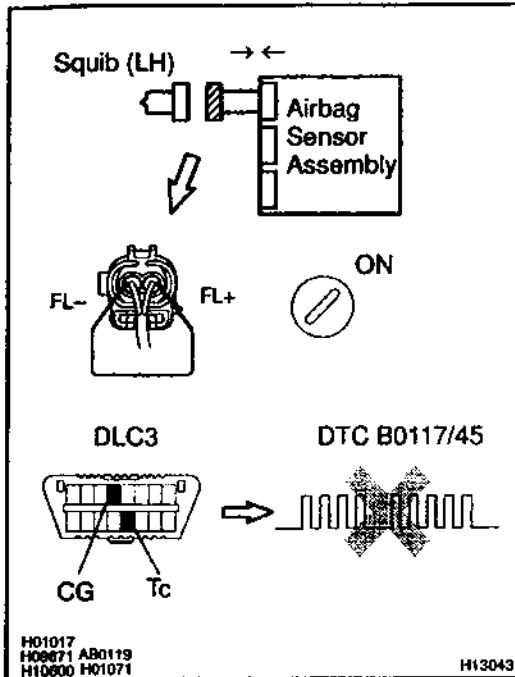

PREPARATION:

- Connect the connector to the airbag sensor assembly.
- Using a service wire, connect FL+ and FL- of the connector (on the side airbag assembly side) between the side airbag assembly (LH) and the airbag sensor assembly.
- Connect negative (-) terminal cable to the battery, and wait at least for 2 seconds.

CHECK:

- Turn the ignition switch to ON and wait at least for 20 seconds.
- Clear the DTC stored in memory (See step 5 on page DI-326).
- Turn the ignition switch to LOCK, and wait at least for 20 seconds.
- Turn the ignition switch to ON, and wait at least for 20 seconds.
- Check the DTC (See page DI-326).

OK:

DTC B0117/45 is not output.

HINT:

Codes other than code B0117/45 may be output at this time, but they are not relevant to this check.

NG

Replace airbag sensor assembly.

OK

4 Check side squib (LH).

Squib (LH)

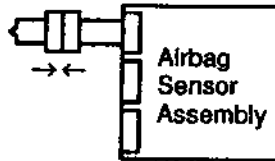

ON



DLC3

DTC B0117/45

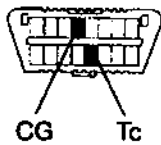
H01018 A80118
H10800 H01071

H12030

PREPARATION:

- Turn the ignition switch to LOCK.
- Disconnect negative (-) terminal cable from the battery, and wait at least for 90 seconds.
- Connect the front side airbag assembly (LH) connector.
- Connect negative (-) terminal cable to the battery, and wait at least for 2 seconds.

CHECK:

- Turn the ignition switch to ON, and wait at least for 20 seconds.
- Clear the DTC stored in memory (See step 5 on page DI-326).
- Turn the ignition switch to LOCK, and wait at least for 20 seconds.
- Turn the ignition switch to ON, and wait at least for 20 seconds.
- Check the DTC (See page DI-326).

OK:**DTC B0117/45 is not output.****HINT:**

Codes other than code B0117/45 may be output at this time, but they are not relevant to this check.

NG**Replace front side airbag assembly (LH).****OK**

From the results of the above inspection, the malfunctioning part can now be considered normal. To make sure of this, use the simulation method to check. If the malfunctioning part can not be detected by the simulation method, replace all SRS components including the wire harness.

DTC	B0118/46	Short in Side Squib (LH) Circuit (to B+)
------------	-----------------	-------------------------------------------------

CIRCUIT DESCRIPTION

The side squib (LH) circuit consists of the airbag sensor assembly and side airbag assembly (LH).

It causes the SRS to deploy when the SRS deployment conditions are satisfied.

For details of the function of each component, see OPERATION on page RS-2.

DTC B0118/46 is recorded when a B+ short is detected in the side squib (LH) circuit.

DTC No.	DTC Detecting Condition	Trouble Area
B0118/46	<ul style="list-style-type: none"> • Short circuit in side squib (LH) wire harness (to B+) • Side squib (LH) malfunction • Airbag sensor assembly malfunction 	<ul style="list-style-type: none"> • Side airbag assembly (LH) • Airbag sensor assembly • Wire harness

WIRING DIAGRAM

See page DI-382.

INSPECTION PROCEDURE

1	Prepare for inspection (See step 1 on page DI-471).
----------	------------------------------------------------------------

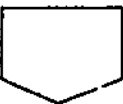

2	Check side squib (LH) circuit.
----------	---------------------------------------

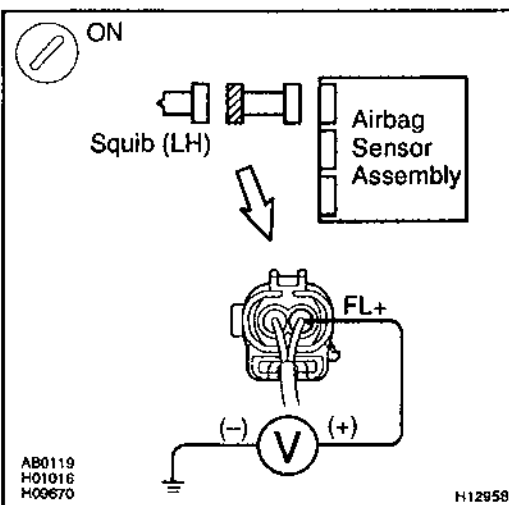

CHECK:

- (a) Turn the ignition switch to ON.
- (b) For the connector (on the side airbag assembly side) between the side airbag assembly (LH) and the airbag sensor assembly, measure the voltage between FL+ and body ground.

OK:

Voltage: 0 V

NG

Repair or replace harness or connector between side airbag assembly (LH) and airbag sensor assembly.



OK

3 Check airbag sensor assembly.

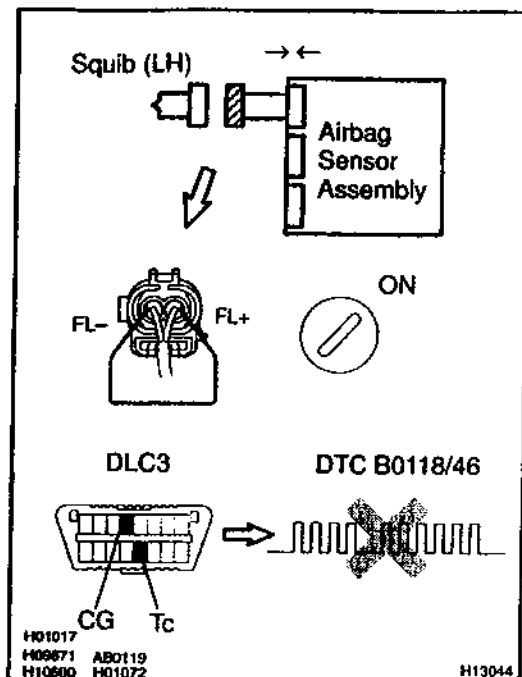

PREPARATION:

- Connect the connector to the airbag sensor assembly.
- Using a service wire, connect FL+ and FL- of the connector (on the side airbag assembly side) between the side airbag assembly (LH) and the airbag sensor assembly.
- Connect negative (-) terminal cable to the battery, and wait at least for 2 seconds.

CHECK:

- Turn the ignition switch to ON and wait at least for 20 seconds.
- Clear the DTC stored in memory (See step 5 on page DI-326).
- Turn the ignition switch to LOCK, and wait at least for 20 seconds.
- Turn the ignition switch to ON, and wait at least for 20 seconds.
- Check the DTC (See page DI-326).

OK:

DTC B0118/46 is not output.

HINT:

Codes other than code B0118/46 may be output at this time, but they are not relevant to this check.

NG

Replace airbag sensor assembly.

OK

4 Check side squib (LH).

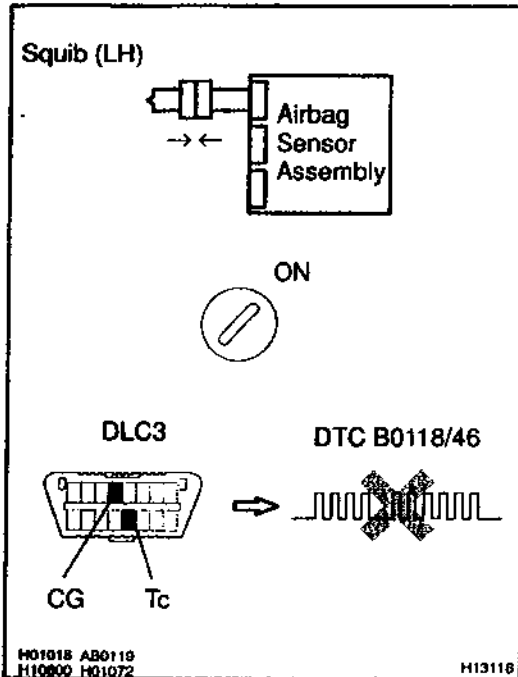

PREPARATION:

- Turn the ignition switch to LOCK.
- Disconnect negative (-) terminal cable from the battery, and wait at least for 90 seconds.
- Connect the side airbag assembly (LH) connector.
- Connect negative (-) terminal cable to the battery, and wait at least for 2 seconds.

CHECK:

- Turn the ignition switch to ON, and wait at least for 20 seconds.
- Clear the DTC stored in memory (See step 5 on page DI-326).
- Turn the ignition switch to LOCK, and wait at least for 20 seconds.
- Turn the ignition switch to ON, and wait at least for 20 seconds.
- Check the DTC (See page DI-326).

OK:

DTC B0118/46 is not output.

HINT:

Codes other than code B0118/46 may be output at this time, but they are not relevant to this check.

NG

Replace side airbag assembly (LH).

OK

From the results of the above inspection, the malfunctioning part can now be considered normal. To make sure of this, use the simulation method to check. If the malfunctioning part can not be detected by the simulation method, replace all SRS components including the wire harness.

DTC	B0130/63	Short in P/T Squib (RH) Circuit
------------	-----------------	----------------------------------------

CIRCUIT DESCRIPTION

The P/T squib (RH) circuit consists of the airbag sensor assembly and seat belt pretensioner (RH). It causes the SRS to deploy when the SRS deployment conditions are satisfied. For details of the function of each component, see OPERATION on page RS-2. DTC B0130/63 is recorded when a short is detected in the P/T squib (RH) circuit.

DTC No.	DTC Detecting Condition	Trouble Area
B0130/63	<ul style="list-style-type: none"> • Short circuit between PR+ wire harness and PR- wire harness of squib • P/T squib (RH) malfunction • Airbag sensor assembly malfunction 	<ul style="list-style-type: none"> • Seat belt pretensioner (RH) • Airbag sensor assembly • Wire harness

WIRING DIAGRAM

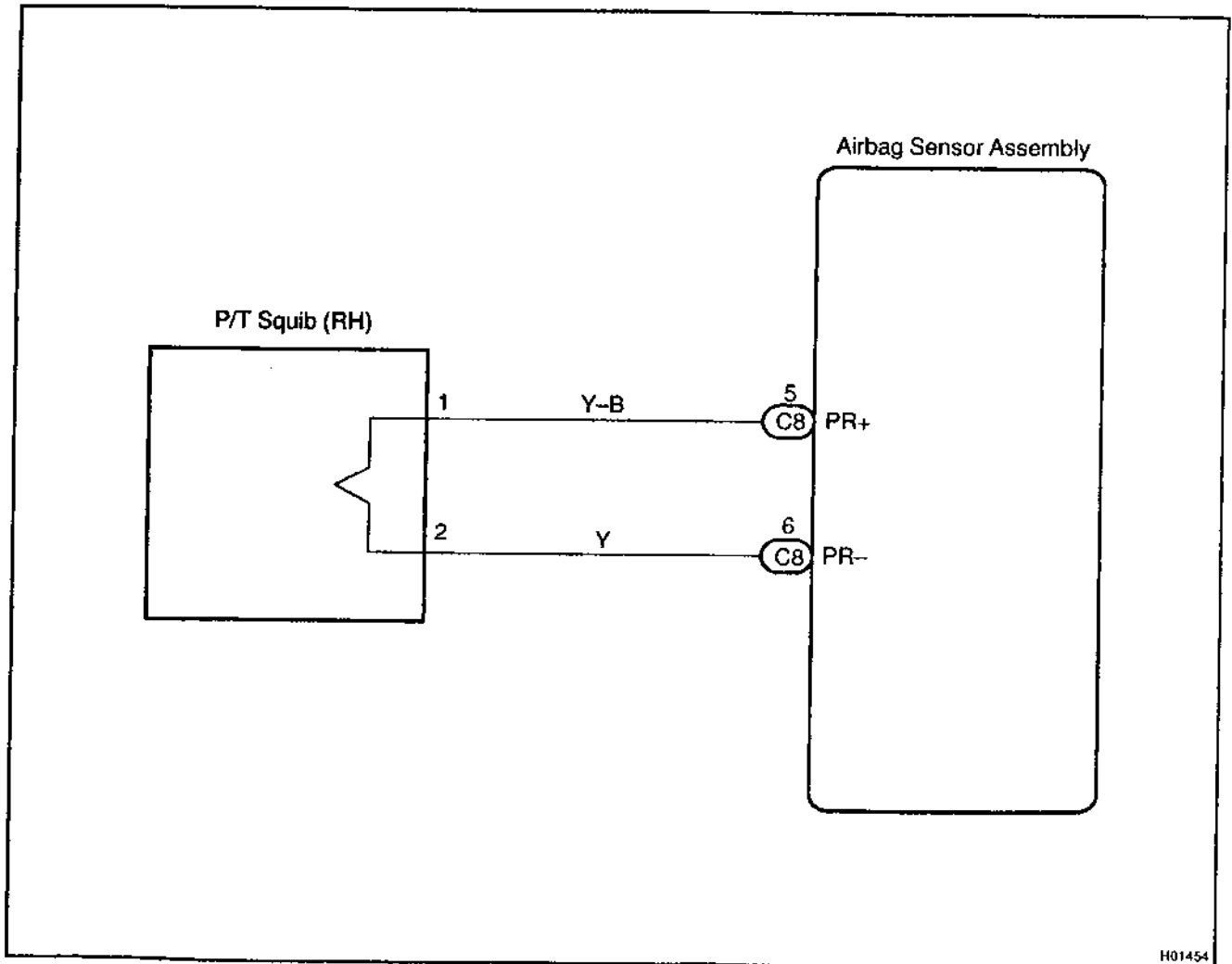

INSPECTION PROCEDURE

1 Prepare for inspection (See step 1 on page DI-471).

2 Check P/T squib (RH) circuit.

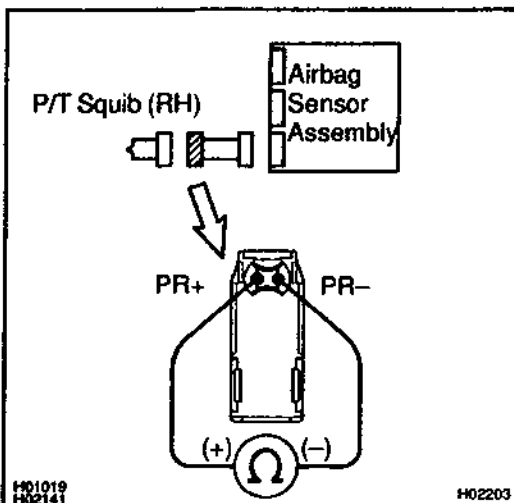
**PREPARATION:**

Release the airbag activation prevention mechanism of the connector (on the airbag sensor assembly side) between the airbag sensor assembly and the seat belt pretensioner (RH) (See page DI-326).

CHECK:

For the connector (on the seat belt pretensioner side) between the seat belt pretensioner (RH) and the airbag sensor assembly, measure the resistance between PR+ and PR-.

OK:

Resistance: 1 M Ω or Higher

NG

Repair or replace harness or connector between seat belt pretensioner (RH) and airbag sensor assembly.

OK

3 Check airbag sensor assembly.

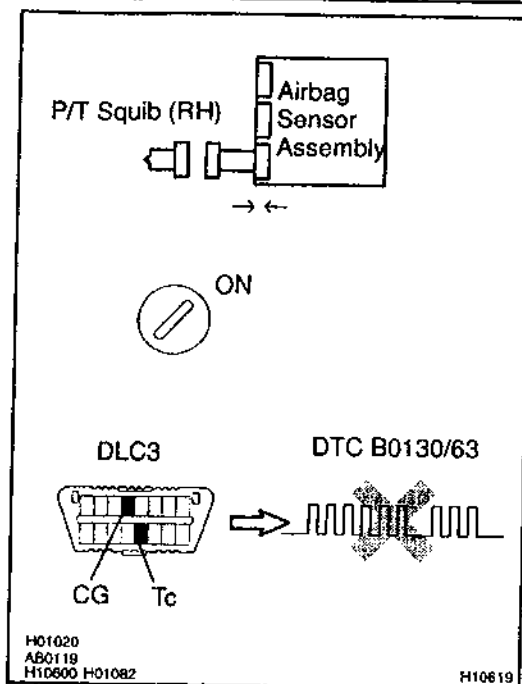

PREPARATION:

- Connect the connector to the airbag sensor assembly.
- Connect negative (-) terminal cable to the battery, and wait at least for 2 seconds.

CHECK:

- Turn the ignition switch to ON and wait at least for 20 seconds.
- Clear the DTC stored in memory (See page DI-326).
- Turn the ignition switch to LOCK, and wait at least for 20 seconds.
- Turn the ignition switch to ON, and wait at least for 20 seconds.
- Check the DTC (See page DI-326).

OK:

DTC B0130/63 is not output.

HINT:

Codes other than code B0130/63 may be output at this time, but they are not relevant to this check.

NG

Replace airbag sensor assembly.

OK

4 Check P/T squib (RH).

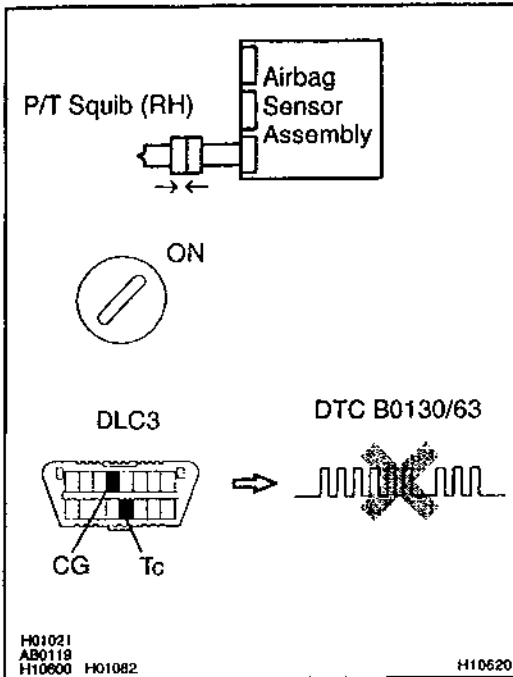

PREPARATION:

- Turn the ignition switch to LOCK.
- Disconnect negative (-) terminal cable from the battery, and wait at least for 90 seconds.
- Connect the seat belt pretensioner (RH) connector.
- Connect negative (-) terminal cable to the battery, and wait at least for 2 seconds.

CHECK:

- Turn the ignition switch to LOCK, and wait at least for 20 seconds.
- Turn the ignition switch to ON, and wait at least for 20 seconds.
- Clear the DTC stored in memory (See page DI-326).
- Turn the ignition switch to LOCK, and wait at least for 20 seconds.
- Turn the ignition switch to ON, and wait at least for 20 seconds.
- Check the DTC (See page DI-326).

OK:

DTC B0130/63 is not output.

HINT:

Codes other than code B0130/63 may be output at this time, but they are not relevant to this check.

NG

Replace seat belt pretensioner (RH).

OK

From the results of the above inspection, the malfunctioning part can now be considered normal. To make sure of this, use the simulation method to check.

DTC	B0131/64	Open in P/T Squib (RH) Circuit
------------	-----------------	---------------------------------------

CIRCUIT DESCRIPTION

The P/T squib circuit (RH) consists of the airbag sensor assembly and seat belt pretensioner (RH). It causes the SRS to deploy when the SRS deployment conditions are satisfied. For details of the function of each component, see OPERATION on page RS-2. DTC B0131/64 is recorded when an open is detected in the P/T squib (RH) circuit.

DTC No.	DTC Detecting Condition	Trouble Area
B0131/64	<ul style="list-style-type: none"> • Open circuit in PR+ wire harness or PR- wire harness of squib • P/T squib (RH) malfunction • Airbag sensor assembly malfunction 	<ul style="list-style-type: none"> • Seat belt pretensioner (RH) • Airbag sensor assembly • Wire harness

WIRING DIAGRAM

See page DI-395.

INSPECTION PROCEDURE

1	Prepare for inspection (See step 1 on page DI-471).
----------	------------------------------------------------------------

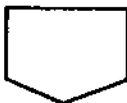

2	Check P/T squib (RH) circuit.
----------	--------------------------------------

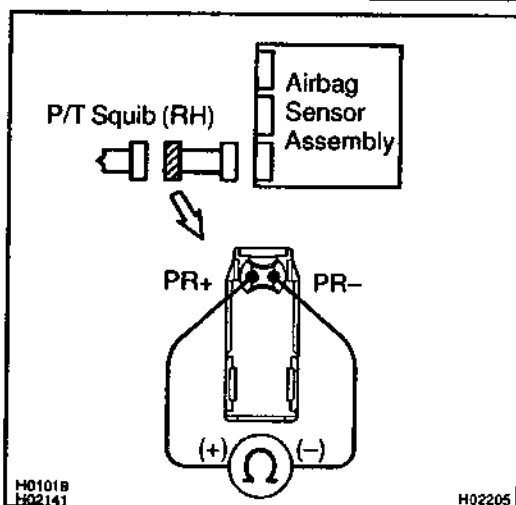

CHECK:

For the connector (on the seat belt pretensioner side) between the seat belt pretensioner (RH) and the airbag sensor assembly, measure the resistance between PR+ and PR-.

OK:

Resistance: Below 1 Ω



Repair or replace harness or connector between seat belt pretensioner (RH) and airbag sensor assembly.



3 Check airbag sensor assembly.

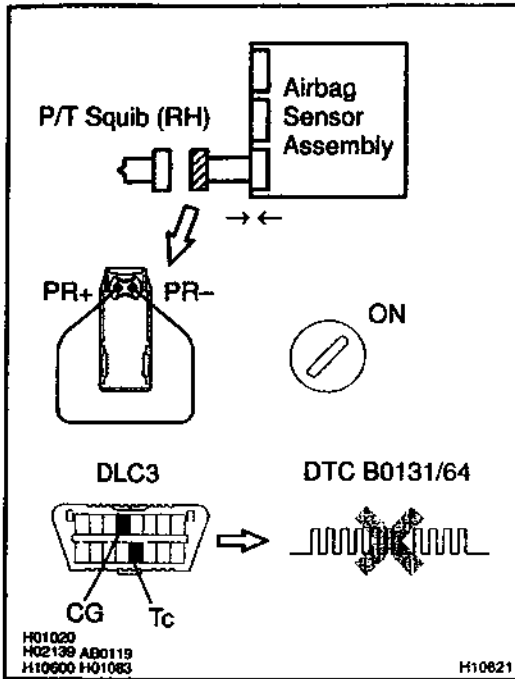

PREPARATION:

- Connect the connector to the airbag sensor assembly.
- Using a service wire, connect PR+ and PR- of the connector (on the seat belt pretensioner side) between the seat belt pretensioner (RH) and the airbag sensor assembly.
- Connect negative (-) terminal cable to the battery, and wait at least for 2 seconds.

CHECK:

- Turn the ignition switch to ON and wait at least for 20 seconds.
- Clear the DTC stored in memory (See page DI-326).
- Turn the ignition switch to LOCK, and wait at least for 20 seconds.
- Turn the ignition switch to ON, and wait at least for 20 seconds.
- Check the DTC (See page DI-326).

OK:

DTC B0131/64 is not output.

HINT:

Codes other than code B0131/64 may be output at this time, but they are not relevant to this check.

NG

Replace airbag sensor assembly.

OK

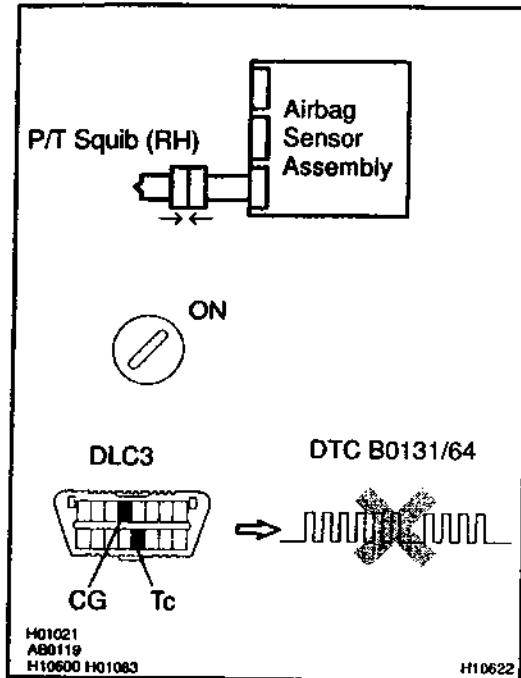
4 Check P/T squib (RH).**PREPARATION:**

- Turn the ignition switch to LOCK.
- Disconnect negative (-) terminal cable from the battery, and wait at least for 90 seconds.
- Connect the seat belt pretensioner (RH) connector.
- Connect negative (-) terminal cable to the battery, and wait at least for 2 seconds.

CHECK:

- Turn the ignition switch to ON, and wait at least for 20 seconds.
- Clear the DTC stored in memory (See page DI-326).
- Turn the ignition switch to LOCK, and wait at least for 20 seconds.
- Turn the ignition switch to ON, and wait at least for 20 seconds.
- Check the DTC (See page DI-326).

OK:**DTC B0131/64 is not output.****HINT:**

Codes other than code B0131/64 may be output at this time, but they are not relevant to this check.

NG**Replace seat belt pretensioner (RH).****OK**

From the results of the above inspection, the malfunctioning part can now be considered normal. To make sure of this, use the simulation method to check.

DTC	B0132/61	Short in P/T Squib (RH) Circuit (to Ground)
------------	-----------------	--------------------------------------------------------

CIRCUIT DESCRIPTION

The P/T squib (RH) circuit consists of the airbag sensor assembly and seat belt pretensioner (RH). It causes the SRS to deploy when the SRS deployment conditions are satisfied. For details of the function of each component, see OPERATION on page RS-2. DTC B0132/61 is recorded when a ground short is detected in the P/T squib (RH) circuit.

DTC No.	DTC Detecting Condition	Trouble Area
B0132/61	<ul style="list-style-type: none"> • Short circuit in P/T squib (RH) wire harness (to ground) • P/T squib (RH) malfunction • Airbag sensor assembly malfunction 	<ul style="list-style-type: none"> • Seat belt pretensioner (RH) • Airbag sensor assembly • Wire harness

WIRING DIAGRAM

See page DI-395.

INSPECTION PROCEDURE

1	Prepare for inspection (See step 1 on page DI-471).
----------	------------------------------------------------------------



2	Check P/T squib (RH) circuit.
----------	--------------------------------------

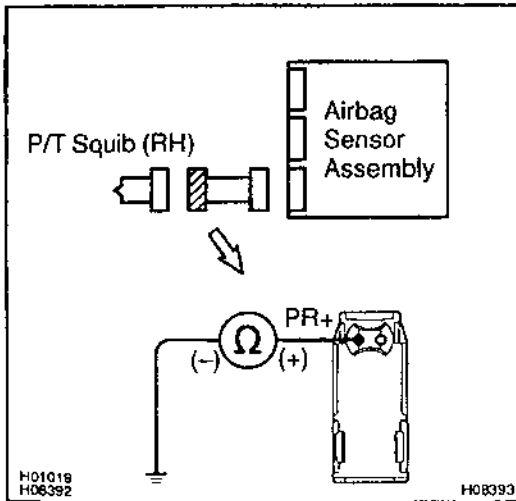

CHECK:

For the connector (on the seat belt pretensioner side) between the seat belt pretensioner (RH) and the airbag sensor assembly, measure the resistance between PR+ and body ground.

OK:

Resistance: 1 MΩ or Higher



Repair or replace harness or connector between seat belt pretensioner (RH) and airbag sensor assembly.

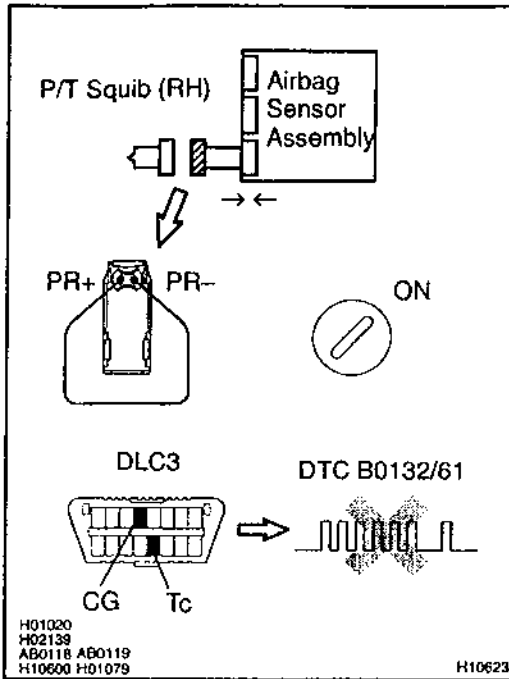

3 Check airbag sensor assembly.**PREPARATION:**

- Connect the connector to the airbag sensor assembly.
- Using a service wire, connect PR+ and PR- of the connector (on the seat belt pretensioner side) between the seat belt pretensioner (RH) and the airbag sensor assembly.
- Connect negative (-) terminal cable to the battery, and wait at least for 2 seconds.

CHECK:

- Turn the ignition switch to ON and wait at least for 20 seconds.
- Clear the DTC stored in memory (See step 5 on page DI-326).
- Turn the ignition switch to LOCK, and wait at least for 20 seconds.
- Turn the ignition switch to ON, and wait at least for 20 seconds.
- Check the DTC (See page DI-326).

OK:

DTC B0132/61 is not output.

HINT:

Codes other than code B0132/61 may be output at this time, but they are not relevant to this check.

NG

Replace airbag sensor assembly.

OK

4

Check P/T squib (RH).

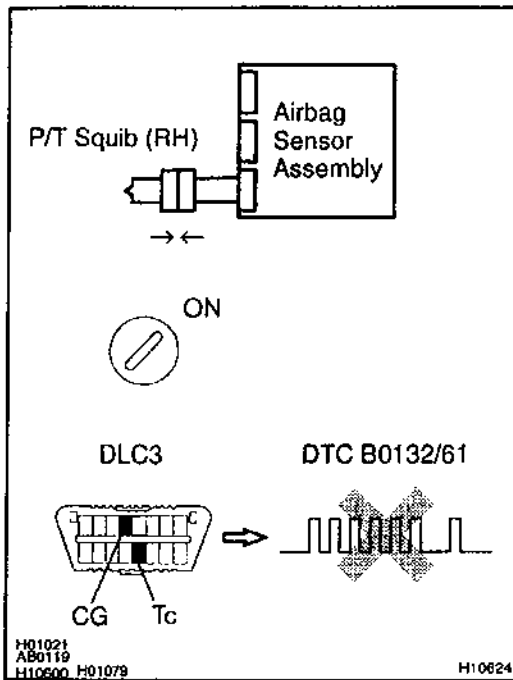
**PREPARATION:**

- Turn the ignition switch to LOCK.
- Disconnect negative (-) terminal cable from the battery, and wait at least for 90 seconds.
- Connect the seat belt pretensioner (RH) connector.
- Connect negative (-) terminal cable to the battery, and wait at least for 2 seconds.

CHECK:

- Turn the ignition switch to ON, and wait at least for 20 seconds.
- Clear the DTC stored in memory (See step 5 on page DI-326).
- Turn the ignition switch to LOCK, and wait at least for 20 seconds.
- Turn the ignition switch to ON, and wait at least for 20 seconds.
- Check the DTC (See page DI-326).

OK:**DTC B0132/61 is not output.****HINT:**

Codes other than code B0132/61 may be output at this time, but they are not relevant to this check.

NG**Replace seat belt pretensioner (RH).****OK**

From the results of the above inspection, the malfunctioning part can now be considered normal. To make sure of this, use the simulation method to check. If the malfunctioning part can not be detected by the simulation method, replace all SRS components including the wire harness.

DTC	B0133/62	Short in P/T Squib (RH) Circuit (to B+)
------------	-----------------	------------------------------------------------

CIRCUIT DESCRIPTION

The P/T squib (RH) circuit consists of the airbag sensor assembly and seat belt pretensioner (RH). It causes the SRS to deploy when the SRS deployment conditions are satisfied. For details of the function of each component, see OPERATION on page RS-2. DTC B0133/62 is recorded when a B+ short is detected in the P/T squib (RH) circuit.

DTC No.	DTC Detecting Condition	Trouble Area
B0133/62	<ul style="list-style-type: none"> • Short circuit in seat belt pretensioner (RH) wire harness (to B+) • P/T squib (RH) malfunction • Airbag sensor assembly malfunction 	<ul style="list-style-type: none"> • Seat belt pretensioner (RH) • Airbag sensor assembly • Wire harness

WIRING DIAGRAM

See page DI-395.

INSPECTION PROCEDURE

1	Prepare for inspection (See step 1 on page DI-471).
----------	------------------------------------------------------------

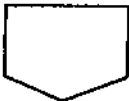

2	Check P/T squib (RH) circuit.
----------	--------------------------------------

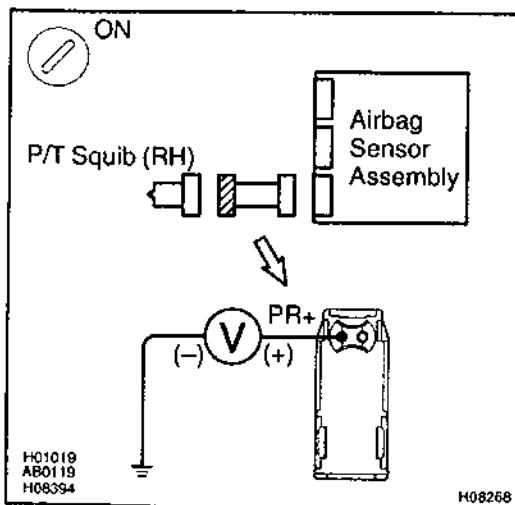

CHECK:

- (a) Turn the ignition switch to ON.
- (b) For the connector (on the seat belt pretensioner side) between the seat belt pretensioner (RH) and the airbag sensor assembly, measure the voltage between PR+ and body ground.

OK:

Voltage: 0 V



Repair or replace harness or connector between seat belt pretensioner (RH) and airbag sensor assembly.

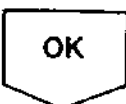

3 Check airbag sensor assembly.

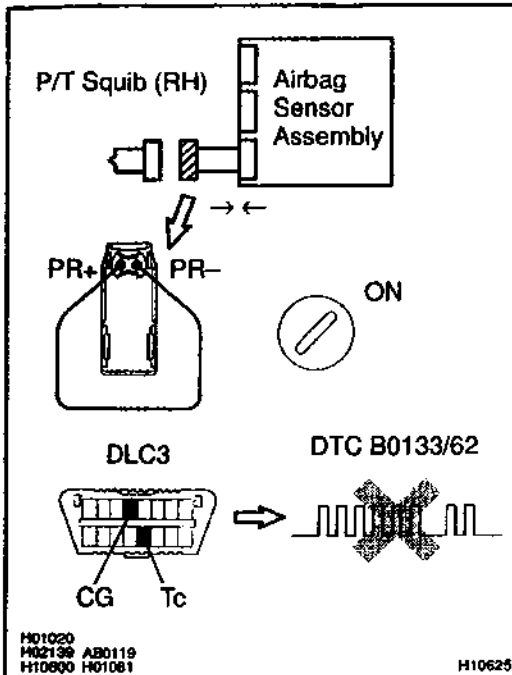

PREPARATION:

- Connect the connector to the airbag sensor assembly.
- Using a service wire, connect PR+ and PR- of the connector (on the seat belt pretensioner side) between the seat belt pretensioner (RH) and the airbag sensor assembly.
- Connect negative (-) terminal cable to the battery, and wait at least for 2 seconds.

CHECK:

- Turn the ignition switch to ON and wait at least for 20 seconds.
- Clear the DTC stored in memory (See step 5 on page DI-326).
- Turn the ignition switch to LOCK, and wait at least for 20 seconds.
- Turn the ignition switch to ON, and wait at least for 20 seconds.
- Check the DTC (See page DI-326).

OK:

DTC B0133/62 is not output.

HINT:

Codes other than code B0133/62 may be output at this time, but they are not relevant to this check.

NG

Replace airbag sensor assembly.

OK

4 Check P/T squib (RH).

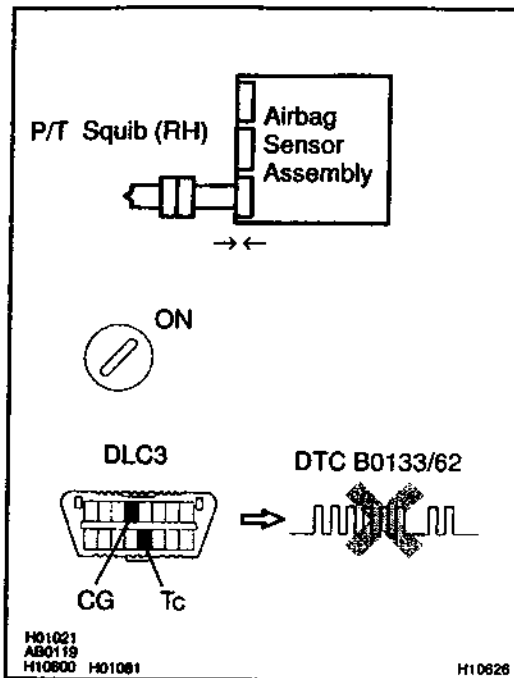

PREPARATION:

- Turn ignition switch to LOCK.
- Disconnect negative (-) terminal cable from the battery, and wait at least for 90 seconds.
- Connect the seat belt pretensioner (RH) connector.
- Connect negative (-) terminal cable to the battery, and wait at least for 2 seconds.

CHECK:

- Turn the ignition switch to ON, and wait at least for 20 seconds.
- Clear the DTC stored in memory (See step 5 on page DI-326).
- Turn the ignition switch to LOCK, and wait at least for 20 seconds.
- Turn the ignition switch to ON, and wait at least for 20 seconds.
- Check the DTC (See page DI-326).

OK:

DTC B0133/62 is not output.

HINT:

Codes other than code B0133/62 may be output at this time, but they are not relevant to this check.

NG

Replace seat belt pretensioner (RH).

OK

From the results of the above inspection, the malfunctioning part can now be considered normal. To make sure of this, use the simulation method to check. If the malfunctioning part can not be detected by the simulation method, replace all SRS components including the wire harness.

DTC	B0135/73	Short in P/T Squib (LH) Circuit
------------	-----------------	----------------------------------------

CIRCUIT DESCRIPTION

The P/T squib (LH) circuit consists of the airbag sensor assembly and seat belt pretensioner (LH).

It causes the SRS to deploy when the SRS deployment conditions are satisfied.

For details of the function of each component, see OPERATION on page RS-2.

DTC B0135/73 is recorded when a short is detected in the P/T squib (LH) circuit.

DTC No.	DTC Detecting Condition	Trouble Area
B0135/73	<ul style="list-style-type: none"> • Short circuit between PL+ wire harness and PL- wire harness of squib • P/T squib (LH) malfunction • Airbag sensor assembly malfunction 	<ul style="list-style-type: none"> • Seat belt pretensioner (LH) • Airbag sensor assembly • Wire harness

WIRING DIAGRAM

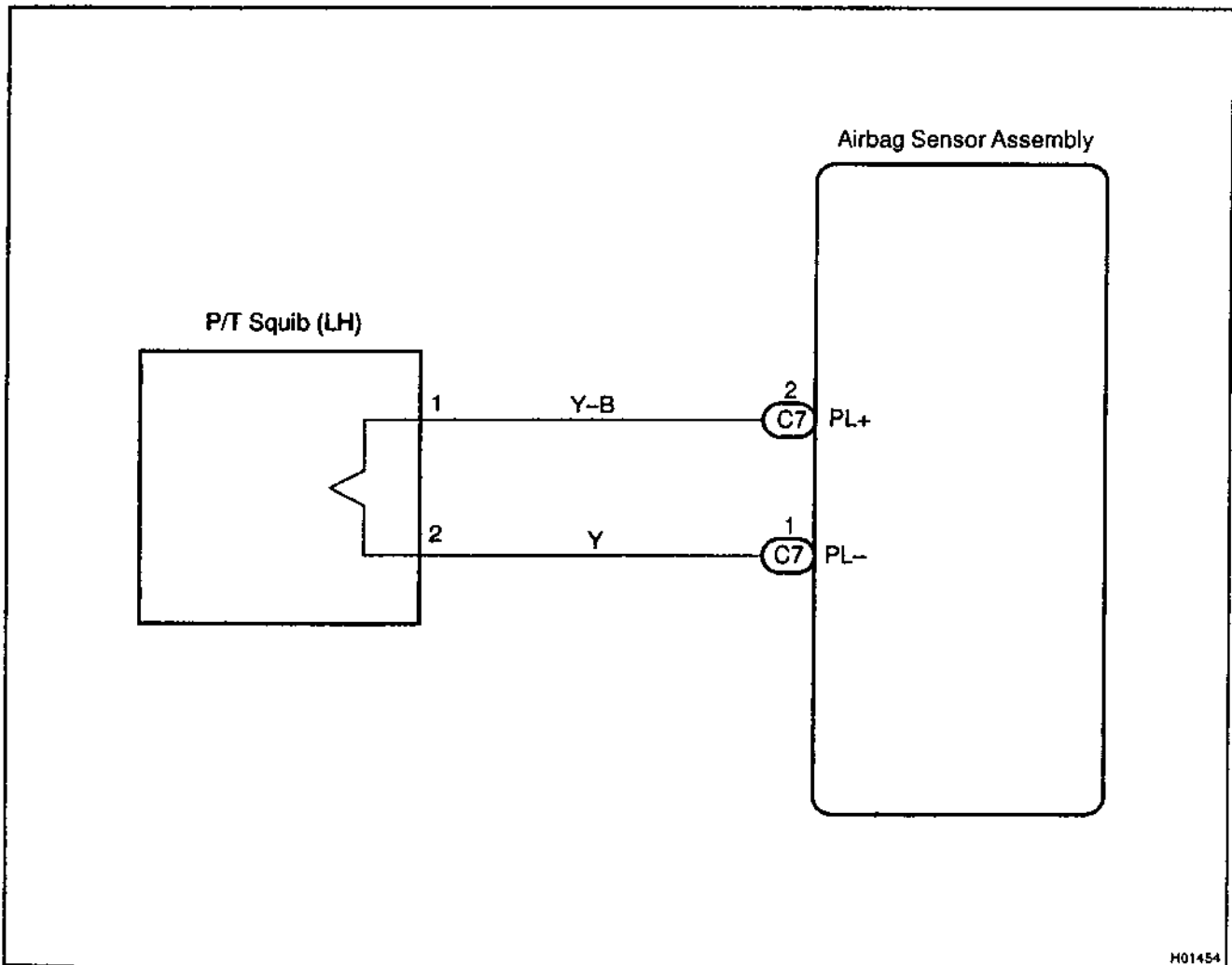

INSPECTION PROCEDURE

1 Prepare for inspection (See step 1 on page DI-471).

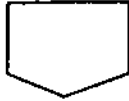

2 Check P/T squib (LH) circuit.

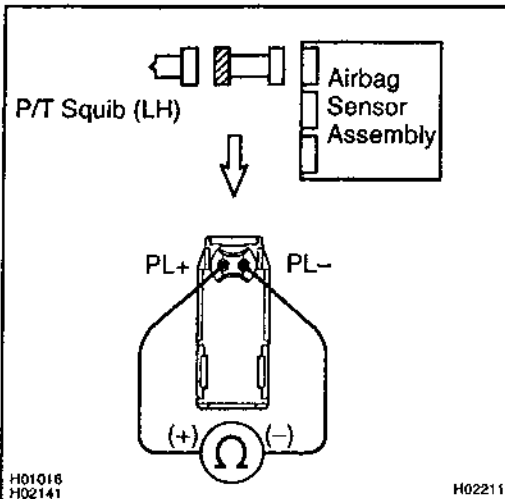
**PREPARATION:**

Release the airbag activation prevention mechanism of the connector (on the airbag sensor assembly side) between the airbag sensor assembly and the seat belt pretensioner (LH) (See page DI-326).

CHECK:

For the connector (on the seat belt pretensioner side) between the seat belt pretensioner (LH) and the airbag sensor assembly, measure the resistance between PL+ and PL-.

OK:

Resistance: 1 MΩ or Higher

NG

Repair or replace harness or connector between seat belt pretensioner (LH) and airbag sensor assembly.

OK

3

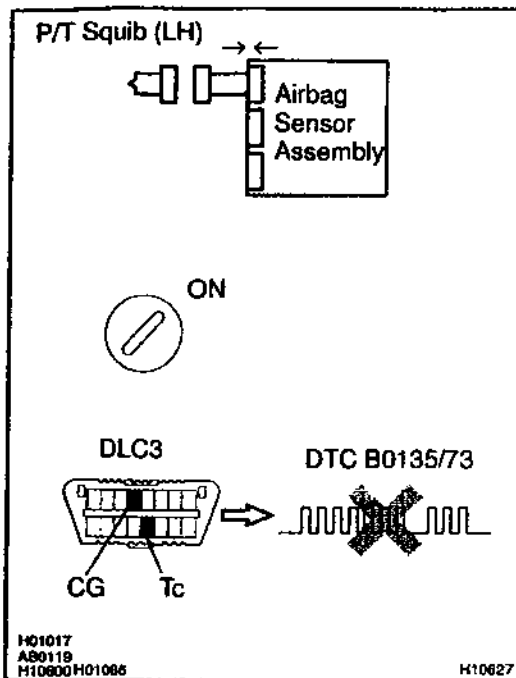
Check airbag sensor assembly.**PREPARATION:**

- (a) Connect the connector to the airbag sensor assembly.
- (b) Connect negative (-) terminal cable to the battery, and wait at least for 2 seconds.

CHECK:

- (a) Turn the ignition switch to ON and wait at least for 20 seconds.
- (b) Clear the DTC stored in memory (See page DI-326).
- (c) Turn the ignition switch to LOCK, and wait at least for 20 seconds.
- (d) Turn the ignition switch to ON, and wait at least for 20 seconds.
- (e) Check the DTC (See page DI-326).

OK:**DTC B0135/73 is not output.****HINT:**

Codes other than code B0135/73 may be output at this time, but they are not relevant to this check.

NG**Replace airbag sensor assembly.****OK**

4 Check P/T squib (LH).

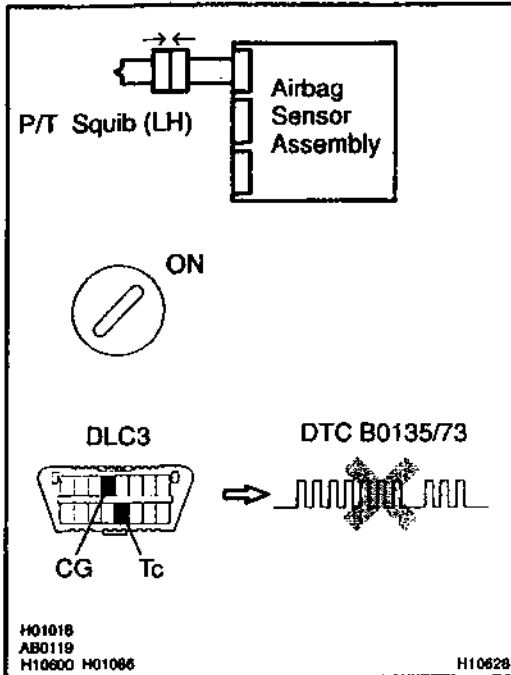

PREPARATION:

- Turn the ignition switch to LOCK.
- Disconnect negative (-) terminal cable from the battery, and wait at least for 90 seconds.
- Connect the seat belt pretensioner (LH) connector.
- Connect negative (-) terminal cable to the battery, and wait at least for 2 seconds.

CHECK:

- Turn the ignition switch to LOCK, and wait at least for 20 seconds.
- Turn the ignition switch to ON, and wait at least for 20 seconds.
- Clear the DTC stored in memory (See page DI-326).
- Turn the ignition switch to LOCK, and wait at least for 20 seconds.
- Turn the ignition switch to ON, and wait at least for 20 seconds.
- Check the DTC (See page DI-326).

OK:

DTC B0135/73 is not output.

HINT:

Codes other than code B0135/73 may be output at this time, but they are not relevant to this check.

NG

Replace seat belt pretensioner (LH).

OK

From the results of the above inspection, the malfunctioning part can now be considered normal. To make sure of this, use the simulation method to check.

DTC	B0136/74	Open in P/T Squib (LH) Circuit
------------	-----------------	---------------------------------------

CIRCUIT DESCRIPTION

The P/T squib circuit (LH) consists of the airbag sensor assembly and seat belt pretensioner (LH).

It causes the SRS to deploy when the SRS deployment conditions are satisfied.

For details of the function of each component, see OPERATION on page RS-2.

DTC B0136/74 is recorded when an open is detected in the P/T squib (LH) circuit.

DTC No.	DTC Detecting Condition	Trouble Area
B0136/74	<ul style="list-style-type: none"> • Open circuit in PL+ wire harness or PL- wire harness of squib • P/T squib (LH) malfunction • Airbag sensor assembly malfunction 	<ul style="list-style-type: none"> • Seat belt pretensioner (LH) • Airbag sensor assembly • Wire harness

WIRING DIAGRAM

See page DI-408.

INSPECTION PROCEDURE

1	Prepare for inspection (See step 1 on page DI-471).
----------	------------------------------------------------------------

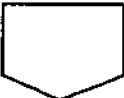

2	Check P/T squib (LH) circuit.
----------	--------------------------------------

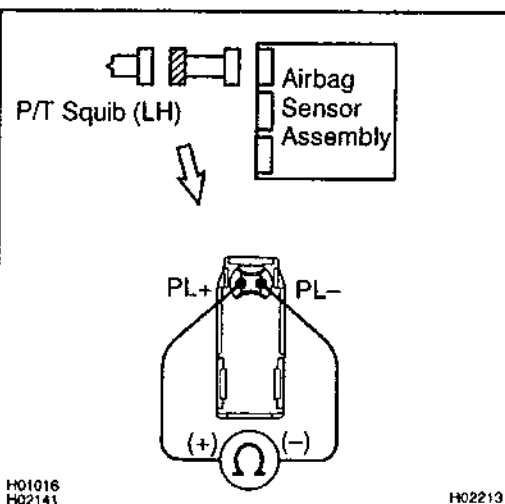

CHECK:

For the connector (on the seat belt pretensioner side) between the seat belt pretensioner (LH) and the airbag sensor assembly, measure the resistance between PL+ and PL-.

OK:

Resistance: Below 1 Ω

NG

Repair or replace harness or connector between seat belt pretensioner (LH) and airbag sensor assembly.



3 Check airbag sensor assembly.

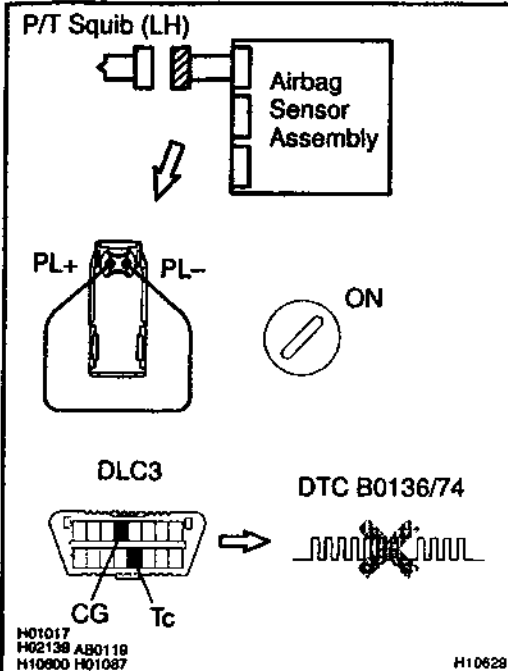

PREPARATION:

- Connect the connector to the airbag sensor assembly.
- Using a service wire, connect PL+ and PL- of the connector (on the seat belt pretensioner side) between the seat belt pretensioner (LH) and the airbag sensor assembly.
- Connect negative (-) terminal cable to the battery, and wait at least for 2 seconds.

CHECK:

- Turn the ignition switch to ON and wait at least for 20 seconds.
- Clear the DTC stored in memory (See page DI-326).
- Turn the ignition switch to LOCK, and wait at least for 20 seconds.
- Turn the ignition switch to ON, and wait at least for 20 seconds.
- Check the DTC (See page DI-326).

OK:

DTC B0136/74 is not output.

HINT:

Codes other than code B0136/74 may be output at this time, but they are not relevant to this check.

NG

Replace airbag sensor assembly.

OK

4 Check P/T squib (LH).

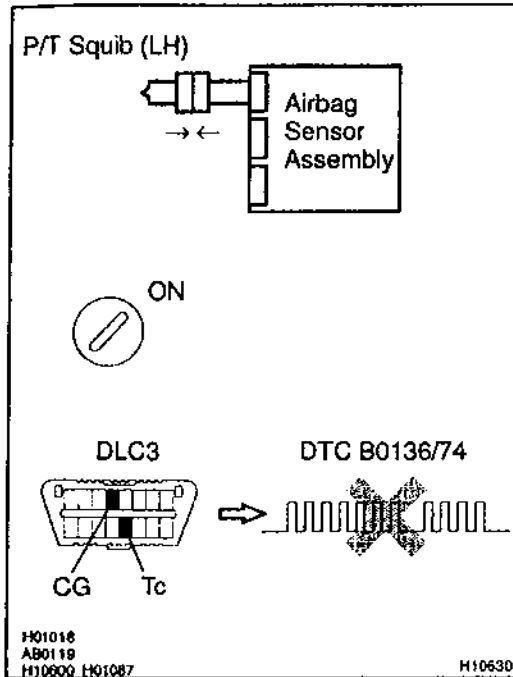

PREPARATION:

- Turn the ignition switch to LOCK.
- Disconnect negative (-) terminal cable from the battery, and wait at least for 90 seconds.
- Connect the seat belt pretensioner (LH) connector.
- Connect negative (-) terminal cable to the battery, and wait at least for 2 seconds.

CHECK:

- Turn the ignition switch to ON, and wait at least for 20 seconds.
- Clear the DTC stored in memory (See page DI-326).
- Turn the ignition switch to LOCK, and wait at least for 20 seconds.
- Turn the ignition switch to ON, and wait at least for 20 seconds.
- Check the DTC (See page DI-326).

OK:

DTC B0136/74 is not output.

HINT:

Codes other than code B0136/74 may be output at this time, but they are not relevant to this check.

NG

Replace seat belt pretensioner (LH).

OK

From the results of the above inspection, the malfunctioning part can now be considered normal. To make sure of this, use the simulation method to check.

DTC	B0137/71	Short in P/T Squib (LH) Circuit (to Ground)
------------	-----------------	--------------------------------------------------------

CIRCUIT DESCRIPTION

The P/T squib (LH) circuit consists of the airbag sensor assembly and seat belt pretensioner (LH). It causes the SRS to deploy when the SRS deployment conditions are satisfied.

For details of the function of each component, see OPERATION on page RS-2.

DTC B0137/71 is recorded when a ground short is detected in the P/T squib (LH) circuit.

DTC No.	DTC Detecting Condition	Trouble Area
B0137/71	<ul style="list-style-type: none"> • Short circuit in P/T squib (LH) wire harness (to ground) • P/T squib (LH) malfunction • Airbag sensor assembly malfunction 	<ul style="list-style-type: none"> • Seat belt pretensioner (LH) • Airbag sensor assembly • Wire harness

WIRING DIAGRAM

See page DI-408.

INSPECTION PROCEDURE

1	Prepare for inspection (See step 1 on page DI-471).
----------	------------------------------------------------------------

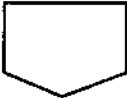

2	Check P/T squib (LH) circuit.
----------	--------------------------------------

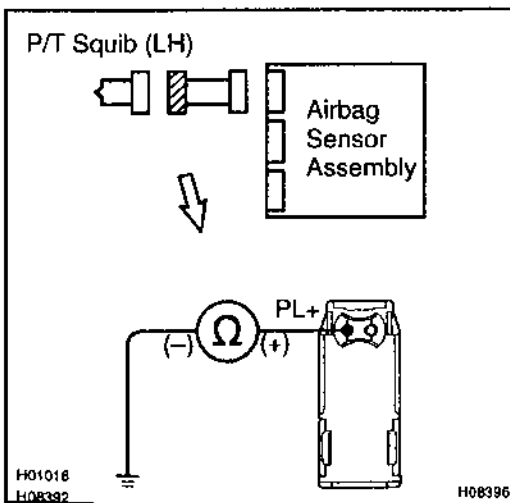

CHECK:

For the connector (on the seat belt pretensioner side) between the seat belt pretensioner (LH) and the airbag sensor assembly, measure the resistance between PL+ and body ground.

OK:

Resistance: 1 MΩ or Higher



Repair or replace harness or connector between seat belt pretensioner (LH) and airbag sensor assembly.



3 Check airbag sensor assembly.

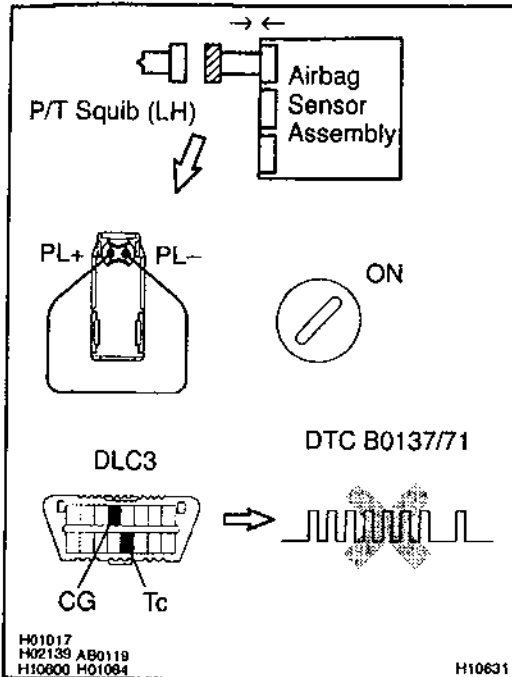

PREPARATION:

- Connect the connector to the airbag sensor assembly.
- Using a service wire, connect PL+ and PL- of the connector (on the seat belt pretensioner side) between the seat belt pretensioner (LH) and the airbag sensor assembly.
- Connect negative (-) terminal cable to the battery, and wait at least for 2 seconds.

CHECK:

- Turn the ignition switch to ON and wait at least for 20 seconds.
- Clear the DTC stored in memory (See step 5 on page DI-326).
- Turn the ignition switch to LOCK, and wait at least for 20 seconds.
- Turn the ignition switch to ON, and wait at least for 20 seconds.
- Check the DTC (See page DI-326).

OK:

DTC B0137/71 is not output.

HINT:

Codes other than code B0137/71 may be output at this time, but they are not relevant to this check.

NG

Replace airbag sensor assembly.

OK

4 Check P/T squib (LH).

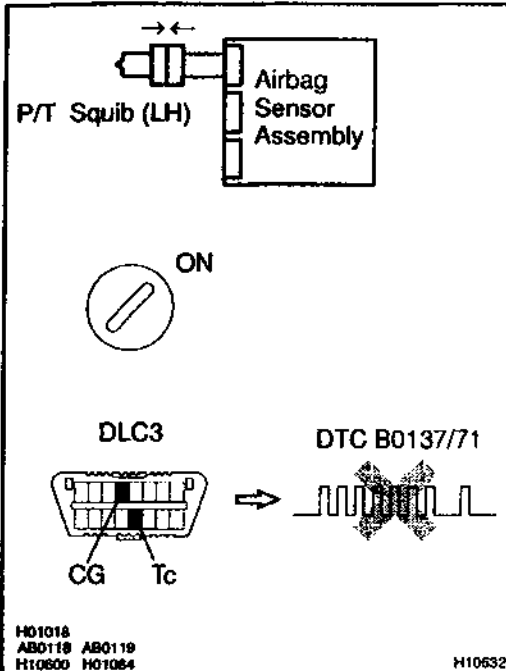

PREPARATION:

- Turn the ignition switch to LOCK.
- Disconnect negative (-) terminal cable from the battery, and wait at least for 90 seconds.
- Connect the seat belt pretensioner (LH) connector.
- Connect negative (-) terminal cable to the battery, and wait at least for 2 seconds.

CHECK:

- Turn the ignition switch to ON, and wait at least for 20 seconds.
- Clear the DTC stored in memory (See step 5 on page DI-326).
- Turn the ignition switch to LOCK, and wait at least for 20 seconds.
- Turn the ignition switch to ON, and wait at least for 20 seconds.
- Check the DTC (See page DI-326).

OK:

DTC B0137/71 is not output.

HINT:

Codes other than code B0137/71 may be output at this time, but they are not relevant to this check.

NG

Replace seat belt pretensioner (LH).

OK

From the results of the above inspection, the malfunctioning part can now be considered normal. To make sure of this, use the simulation method to check. If the malfunctioning part can not be detected by the simulation method, replace all SRS components including the wire harness.

DTC	B0138/72	Short in P/T Squib (LH) Circuit (to B+)
------------	-----------------	------------------------------------------------

CIRCUIT DESCRIPTION

The P/T squib (LH) circuit consists of the airbag sensor assembly and seat belt pretensioner (LH). It causes the SRS to deploy when the SRS deployment conditions are satisfied. For details of the function of each component, see OPERATION on page RS-2. DTC B0138/72 is recorded when a B+ short is detected in the P/T squib (LH) circuit.

DTC No.	DTC Detecting Condition	Trouble Area
B0138/72	<ul style="list-style-type: none"> • Short circuit in seat belt pretensioner (LH) wire harness (to B+) • P/T squib (LH) malfunction • Airbag sensor assembly malfunction 	<ul style="list-style-type: none"> • Seat belt pretensioner (LH) • Airbag sensor assembly • Wire harness

WIRING DIAGRAM

See page DI-408.

INSPECTION PROCEDURE

1	Prepare for inspection (See step 1 on page DI-471).
----------	------------------------------------------------------------



2	Check P/T squib (LH) circuit.
----------	--------------------------------------

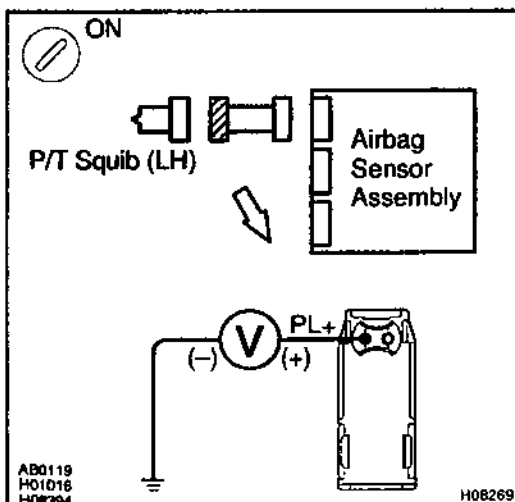

CHECK:

- Turn the ignition switch to ON.
- For the connector (on the seat belt pretensioner side) between the seat belt pretensioner (LH) and the airbag sensor assembly, measure the voltage between PL+ and body ground.

OK:

Voltage: 0 V

NG

Repair or replace harness or connector between seat belt pretensioner (LH) and airbag sensor assembly.



OK

3 Check airbag sensor assembly.

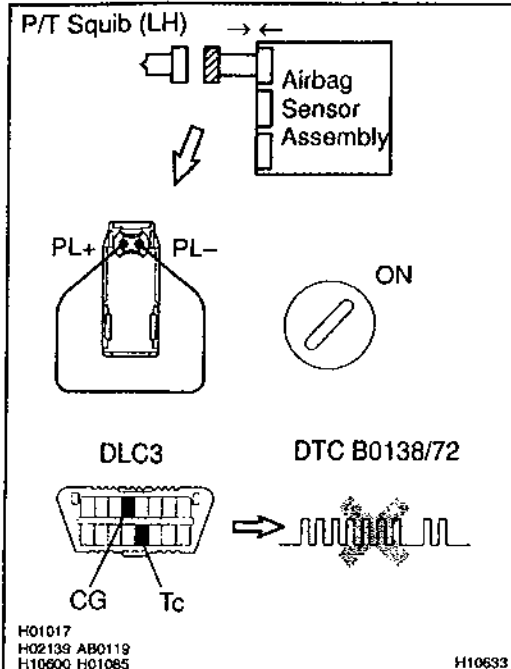

PREPARATION:

- Connect the connector to the airbag sensor assembly.
- Using a service wire, connect PL+ and PL- of the connector (on the seat belt pretensioner side) between the seat belt pretensioner (LH) and the airbag sensor assembly.
- Connect negative (-) terminal cable to the battery, and wait at least for 2 seconds.

CHECK:

- Turn the ignition switch to ON and wait at least for 20 seconds.
- Clear the DTC stored in memory (See step 5 on page DI-326).
- Turn the ignition switch to LOCK, and wait at least for 20 seconds.
- Turn the ignition switch to ON, and wait at least for 20 seconds.
- Check the DTC (See page DI-326).

OK:

DTC B0138/72 is not output.

HINT:

Codes other than code B0138/72 may be output at this time, but they are not relevant to this check.

NG

Replace airbag sensor assembly.

OK

4 Check P/T squib (LH).

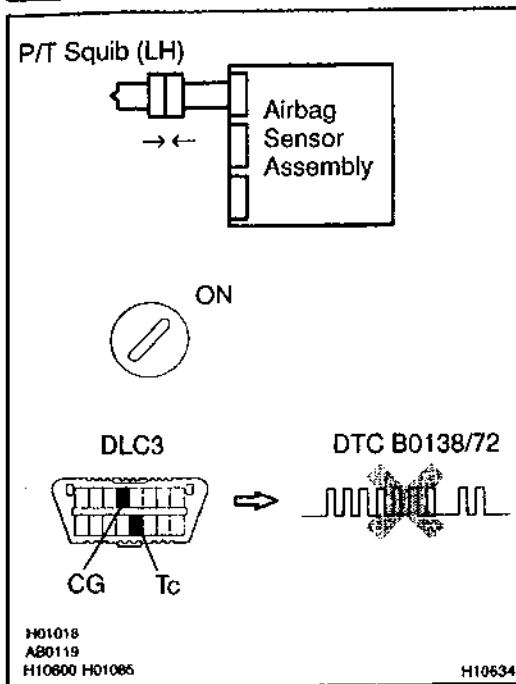

PREPARATION:

- Turn the ignition switch to LOCK.
- Disconnect negative (-) terminal cable from the battery, and wait at least for 90 seconds.
- Connect the seat belt pretensioner (LH) connector.
- Connect negative (-) terminal cable to the battery, and wait at least for 2 seconds.

CHECK:

- Turn the ignition switch to ON, and wait at least for 20 seconds.
- Clear the DTC stored in memory (See step 5 on page DI-326).
- Turn the ignition switch to LOCK, and wait at least for 20 seconds.
- Turn the ignition switch to ON, and wait at least for 20 seconds.
- Check the DTC (See page DI-326).

OK:

DTC B0138/72 is not output.

HINT:

Codes other than code B0138/72 may be output at this time, but they are not relevant to this check.

NG

Replace seat belt pretensioner (LH).

OK

From the results of the above inspection, the malfunctioning part can now be considered normal. To make sure of this, use the simulation method to check. If the malfunctioning part can not be detected by the simulation method, replace all SRS components including the wire harness.

DTC	B1100/31	Airbag Sensor Assembly Malfunction
------------	-----------------	-------------------------------------------

CIRCUIT DESCRIPTION

The airbag sensor assembly consists of a airbag sensor, safing sensor, drive circuit, diagnosis circuit and ignition control, etc.

It receives signals from the airbag sensor, judges whether or not the SRS must be activated, and detects diagnosis system malfunction.

DTC B1100/31 is recorded when occurrence of a malfunction in the airbag sensor assembly is detected.

DTC No.	DTC Detecting Condition	Trouble Area
B1100/31	• Airbag sensor assembly malfunction	• Airbag sensor assembly

INSPECTION PROCEDURE

HINT:

When a malfunction code other than code B1100/31 is displayed at the same time, first repair the malfunction indicated by the malfunction code other than code B1100/31.

1	Prepare for inspection (See step 1 on page DI-471).
----------	------------------------------------------------------------



2	Check voltage at IG1 and IG2 of airbag sensor assembly.
----------	----------------------------------------------------------------

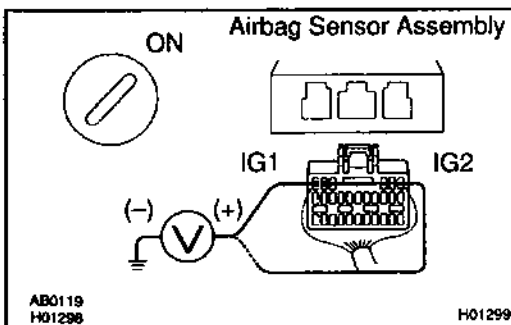

CHECK:

- (a) Turn the ignition switch to ON.
- (b) Measure the voltage between body ground and each of terminals IG1 and IG2 of the airbag sensor assembly connector.

OK:

Voltage: 10 - 14 V

NG	Check that an abnormality occurs on the battery and charging system.
-----------	-----------------------------------------------------------------------------



3

Is DTC B1100/31 output again?

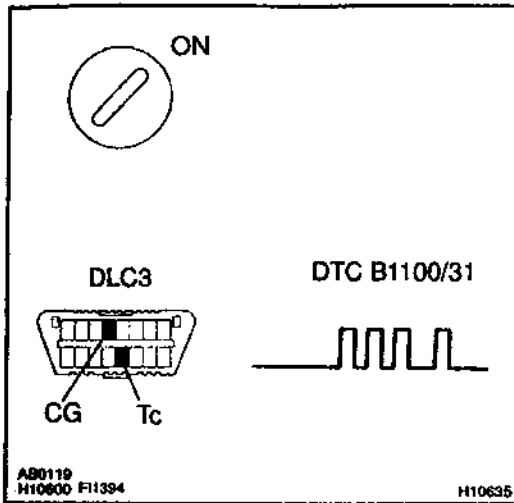
**PREPARATION:**

Clear the DTC (See step 5 on page DI-326).

CHECK:

- Turn the ignition switch to LOCK, and wait at least for 20 seconds.
- Turn the ignition switch to ON, and wait at least for 20 seconds.
- Repeat operation in step (a) and (b) at least 5 times.
- Check the DTC (See page DI-326).

HINT:

Codes other than code B1100/31 may be output at this time, but they are not relevant to this check.

NO

Using simulation method, reproduce malfunction symptoms (See page IN-20).

YES

Replace airbag sensor assembly.

DTC	B1140/32	Side Airbag Sensor Assembly (RH) Malfunction
------------	-----------------	---------------------------------------------------------

CIRCUIT DESCRIPTION

The side airbag sensor assembly (RH) consists of the safing sensor, diagnosis circuit and lateral deceleration sensor, etc.

It receives signals from the lateral deceleration sensor, judges whether or not the SRS must be activated, and detects diagnosis system malfunction.

DTC B1140/32 is recorded when occurrence of a malfunction in the side airbag sensor assembly (RH) is detected.

DTC No.	DTC Detecting Condition	Trouble Area
B1140/32	•Side airbag sensor assembly (RH) malfunction	<ul style="list-style-type: none"> •Side airbag sensor assembly (RH) •Wire harness •Airbag sensor assembly

WIRING DIAGRAM

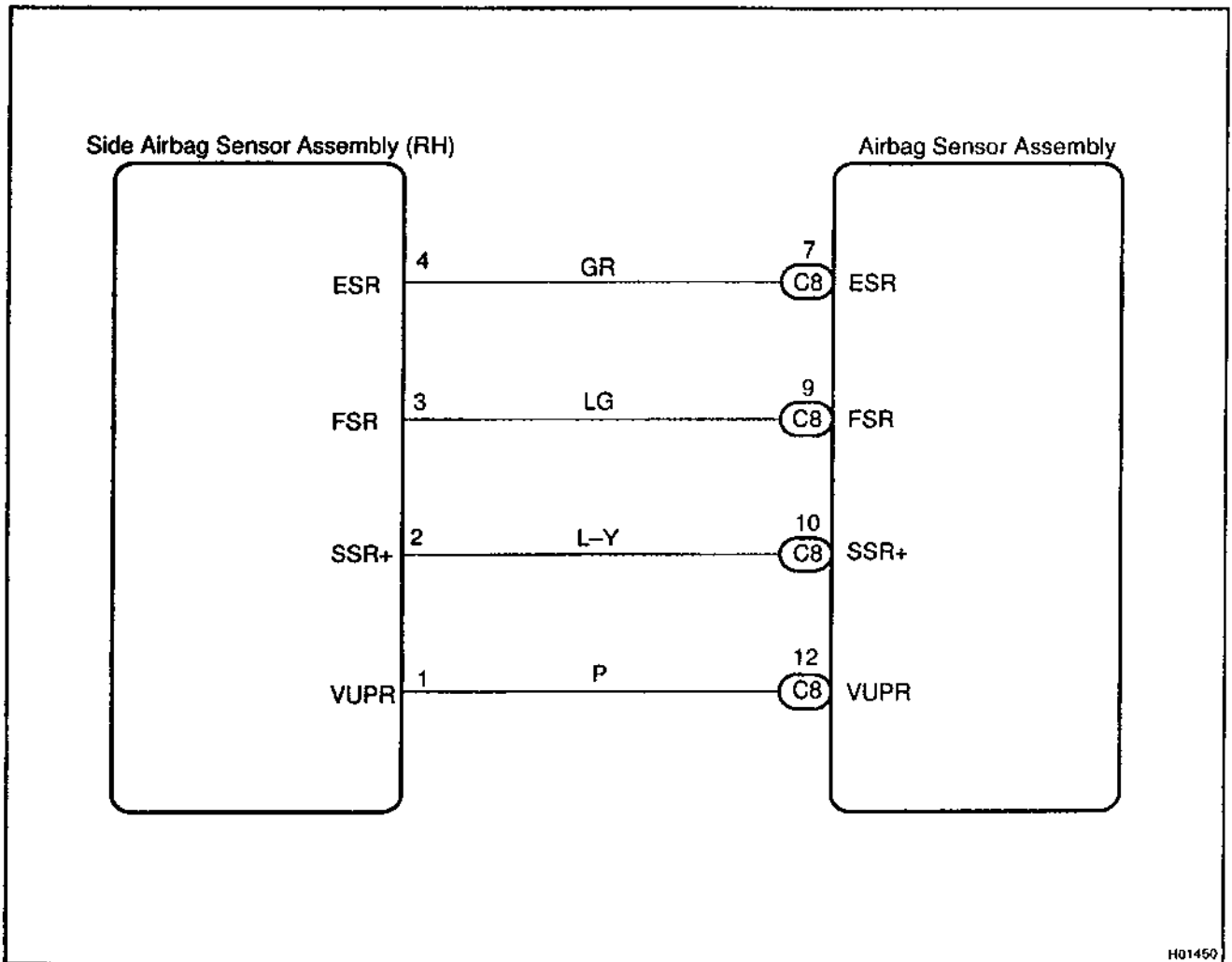

INSPECTION PROCEDURE

1	Is DTC B1140/32 out put?
----------	---------------------------------

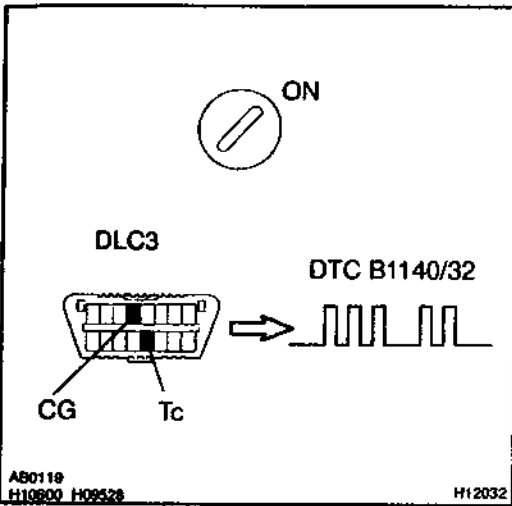

CHECK:

- (a) Turn the ignition switch to ON, and wait at least for 20 seconds.
- (b) Clear the DTC stored in memory (See page DI-326).
- (c) Turn the ignition switch to LOCK, and wait at least for 20 seconds.
- (d) Turn the ignition switch to ON, and wait at least for 20 seconds.
- (e) Check the DTC (See page DI-326).

HINT:

Codes other than code B1140/32 may be output at this time, but they are not relevant to this check.

YES

The malfunctioning part can now be considered normal. To make sure of this, use the simulation method to check.

NO

2	Is connector of side airbag sensor assembly (RH) properly connected?
----------	-----------------------------------------------------------------------------

3	Prepare for inspection (See step 1 on DI-471).
----------	-------------------------------------------------------

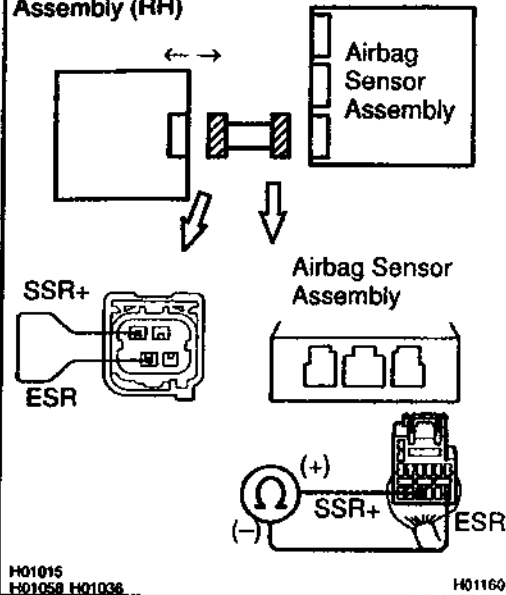
4 Check wire harness.**Side Airbag Sensor Assembly (RH)****PREPARATION:**

- Disconnect the side airbag sensor assembly (RH) connector.
- Using a service wire, connect SSR+ and ESR of the connector (on the side airbag sensor assembly side) between the side airbag sensor assembly (RH) and airbag sensor assembly.

CHECK:

For the connector (on the airbag sensor assembly side) between the side airbag sensor assembly (RH) and the airbag sensor assembly, measure the resistance between SSR+ and ESR.

OK:

Resistance: Below 1 Ω

NG

Repair or replace harness or connector between side airbag sensor assembly (RH) and airbag sensor assembly.

OK

5	Check wire harness.
----------	----------------------------

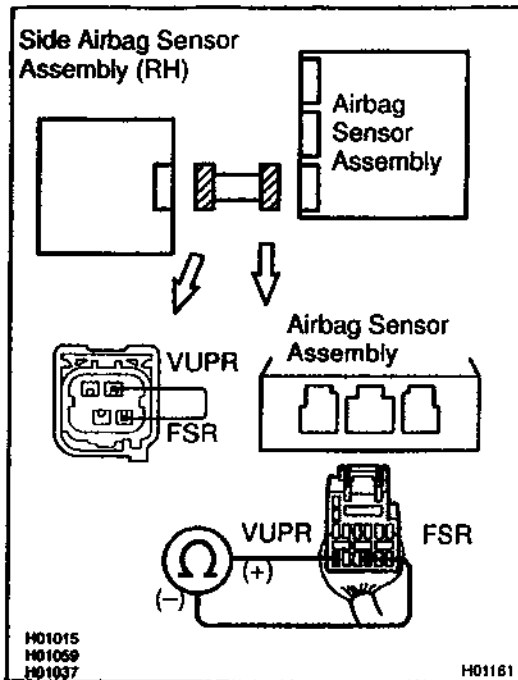
**PREPARATION:**

Using a service wire, connect VUPR and FSR of the connector (on the side airbag sensor assembly side) between the side airbag sensor assembly (RH) and airbag sensor assembly.

CHECK:

For the connector (on the airbag sensor assembly side) between the side airbag sensor assembly (RH) and the airbag sensor assembly, measure the resistance between VUPR and FSR.

OK:

Resistance: Below 1 Ω

NG

Repair or replace harness or connector between side airbag sensor assembly (RH) and airbag sensor assembly.

OK

6 Check wire harness (to ground).

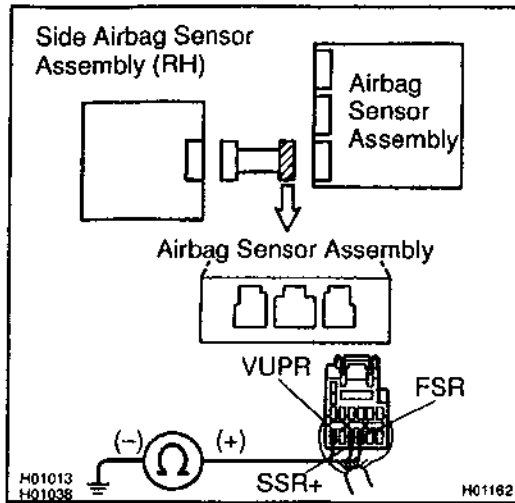

CHECK:

For the connector (on the airbag sensor assembly side) between the side airbag sensor assembly (RH) and the airbag sensor assembly, measure the resistance between body ground and each of SSR+, VUPR and FSR.

OK:

Resistance: Below 1 Ω

NG

Repair or replace harness or connector between side airbag sensor assembly (RH) and airbag sensor assembly.

OK

7 Check wire harness (to B+).

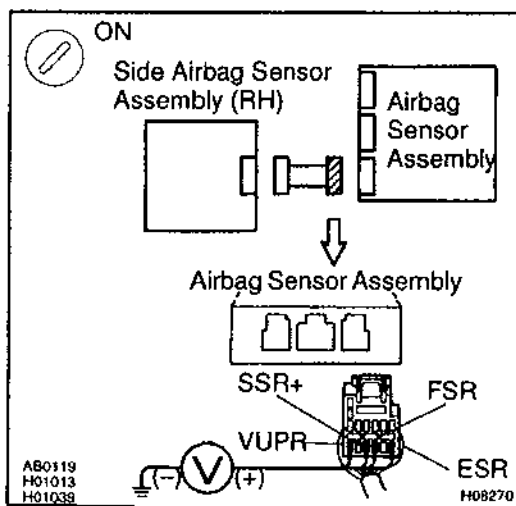

CHECK:

- Turn ignition switch to ON.
- For the connector (on the airbag sensor assembly side) between the side airbag sensor assembly (RH) and the airbag sensor assembly, measure the voltage between the body ground and each of SSR+, VUPR, ESR and FSR.

OK:

Voltage: 0 V

NG

Repair or replace harness or connector between side airbag sensor assembly (RH) and airbag sensor assembly.

OK

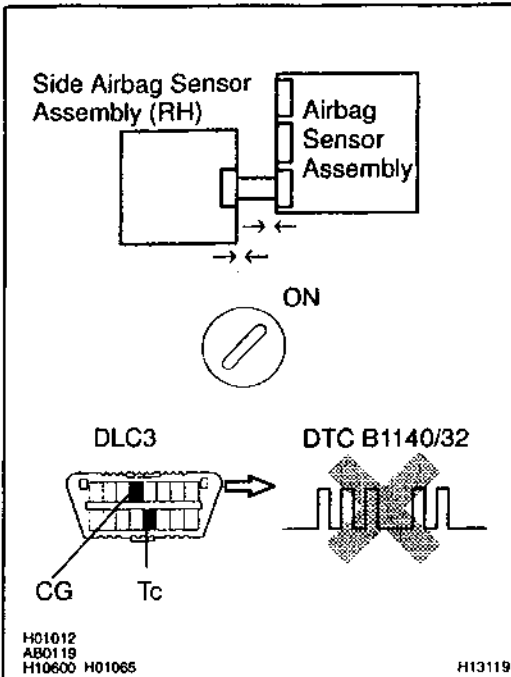
8 Is DTC B1140/32 out put again?
**PREPARATION:**

- Connect the connector to the side airbag sensor assembly (RH).
- Connect the connector to the airbag sensor assembly.
- Connect negative (-) terminal cable to the battery, and wait at least for 2 seconds.

CHECK:

- Turn the ignition switch to ON, and wait at least for 20 seconds.
- Clear the DTC stored in memory (See step 5 on page DI-326).
- Turn the ignition switch to LOCK, and wait at least for 20 seconds.
- Turn the ignition switch to ON, and wait at least for 20 seconds.
- Check the DTC (See page DI-326).

OK:

DTC B1140/32 is not output.

HINT:

Codes other than code B1140/32 may be output at this time, but they are not relevant to this check.

NG

Go to step 9.

OK

From the results of the above inspection, the malfunctioning part can now be considered normal. To make sure of this, use the simulation method to check.

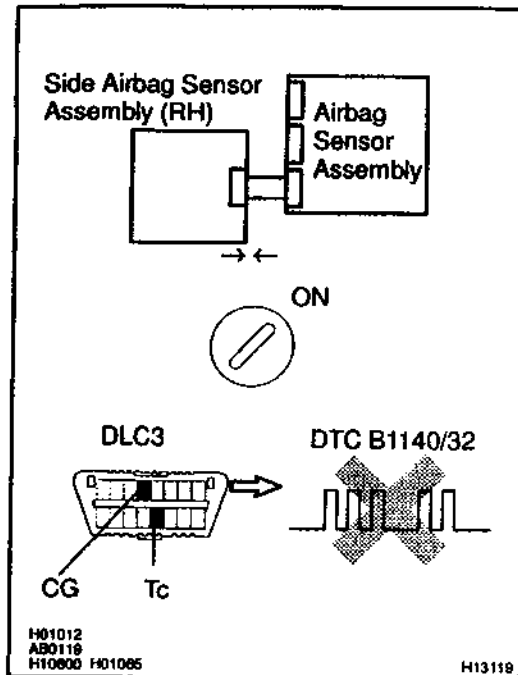
9 Check airbag sensor assembly.
**PREPARATION:**

- Turn the ignition switch to LOCK.
- Disconnect negative (-) terminal cable from the battery, and wait at least for 90 seconds.
- Disconnect the side airbag sensor (RH) from the connector and connect the side airbag sensor (LH) to the connector.
- Connect negative (-) terminal cable to the battery, and wait at least for 2 seconds.

CHECK:

- Turn the ignition switch to ON, and wait at least for 20 seconds.
- Clear the DTC stored in memory (See step 5 on page DI-326).
- Turn the ignition switch to LOCK, and wait at least for 20 seconds.
- Turn the ignition switch to ON, and wait at least for 20 seconds.
- Check the DTC (See page DI-326).

OK:

DTC B1140/32 is not output.

HINT:

Codes other than code B1140/32 may be output at this time, but they are not relevant to this check.

NG

Replace airbag sensor assembly.

OK

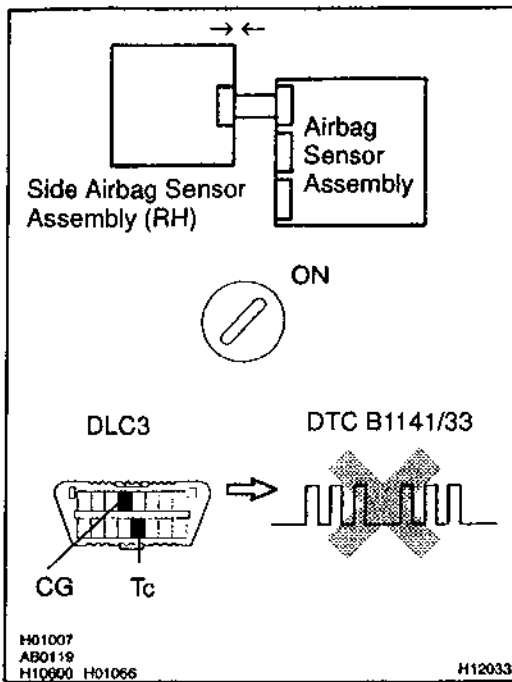
10 Check side airbag sensor assembly (RH).
**PREPARATION:**

- Turn the ignition switch to LOCK.
- Disconnect negative (-) terminal cable from the battery, and wait at least for 90 seconds.
- Connect the side airbag sensor (RH) to the connector that the side airbag sensor (LH) was connected to.
- Connect negative (-) terminal cable to the battery, and wait at least for 2 seconds.

CHECK:

- Turn the ignition switch to ON, and wait at least for 20 seconds.
- Clear the DTC stored in memory (See step 5 on page DI-326).
- Turn the ignition switch to LOCK, and wait at least for 20 seconds.
- Turn the ignition switch to ON, and wait at least for 20 seconds.
- Check the DTC (See page DI-326).

OK:

DTC B1141/33 is not output.

HINT:

Codes other than code B1141/33 may be output at this time, but they are not relevant to this check.

NG

Replace side airbag sensor assembly (RH).

OK

From the results of the above inspection, the malfunctioning part can now be considered normal. To make sure of this, use the simulation method to check.

DTC	B1141/33	Side Airbag Sensor Assembly (LH) Malfunction
------------	-----------------	---------------------------------------------------------

CIRCUIT DESCRIPTION

The side airbag sensor assembly (LH) consists of the safing sensor, diagnosis circuit and lateral deceleration sensor, etc.

It receives signals from the lateral deceleration sensor, judges whether or not the SRS must be activated, and detects diagnosis system malfunction.

DTC B1141/33 is recorded when occurrence of a malfunction in the side airbag sensor assembly (LH) is detected.

DTC No.	DTC Detecting Condition	Trouble Area
B1141/33	• Side airbag sensor assembly (LH) malfunction	<ul style="list-style-type: none"> • Side airbag sensor assembly (LH) • Wire harness • Airbag sensor assembly

WIRING DIAGRAM

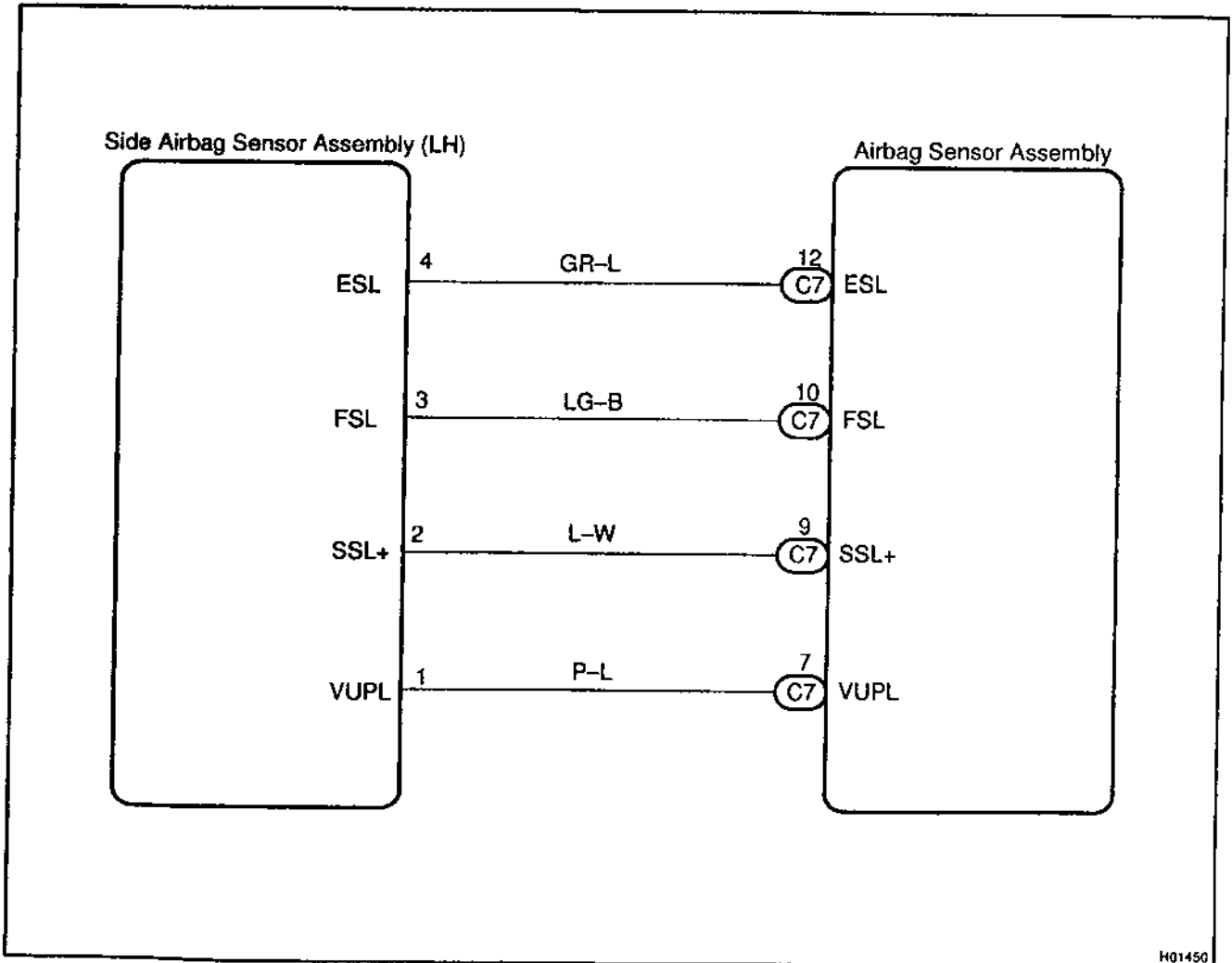

INSPECTION PROCEDURE

1 Is DTC B1141/33 out put?

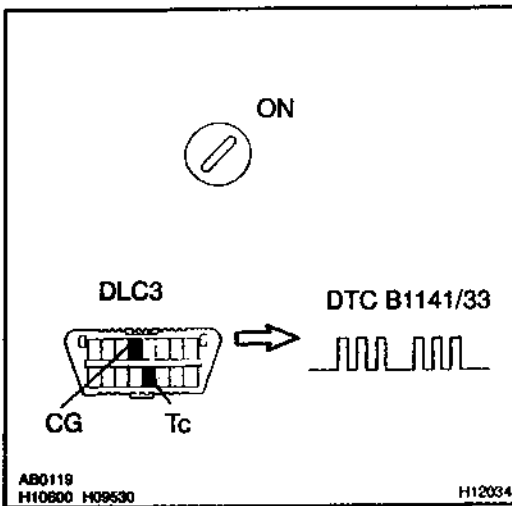
**CHECK:**

- Turn the ignition switch to ON, and wait at least for 20 seconds.
- Clear the DTC stored in memory (See step 5 on page DI-326).
- Turn the ignition switch to LOCK, and wait at least for 20 seconds.
- Turn the ignition switch to ON, and wait at least for 20 seconds.
- Check the DTC (See page DI-326).

HINT:

Codes other than code B1141/33 may be output at this time, but they are not relevant to this check.

YES

The malfunctioning part can now be considered normal. To make sure of this, use the simulation method to check.

NO

2 Is connector of side airbag sensor assembly (LH) properly connected?

3 Prepare for inspection (See step 1 on page DI-471).

4 Check wire harness.

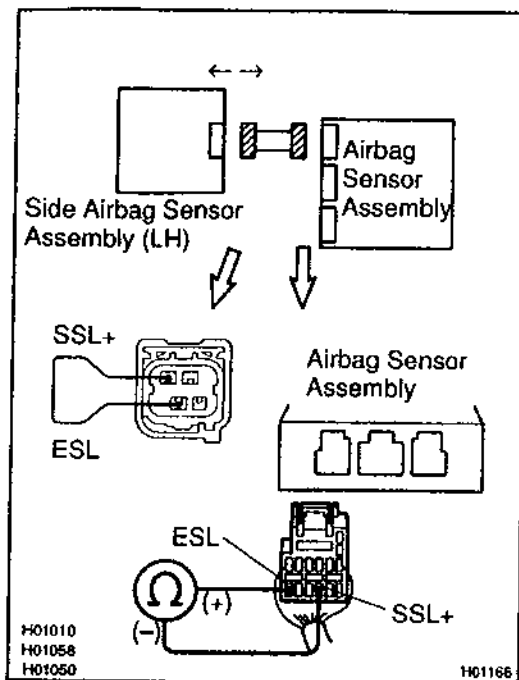

PREPARATION:

- Disconnect the side airbag sensor assembly (LH).
- Using a service wire, connect SSL+ and ESL of the connector (on the side airbag sensor assembly side) between the side airbag sensor assembly (LH) and the airbag sensor assembly.

CHECK:

For the connector (on the airbag sensor assembly side) between the side airbag sensor assembly (LH) and the airbag sensor assembly, measure the resistance between SSL+ and ESL.

OK:

Resistance: Below 1 Ω

NG

Repair or replace harness or connector between side airbag sensor assembly (LH) and airbag sensor assembly.

OK

5

Check wire harness.

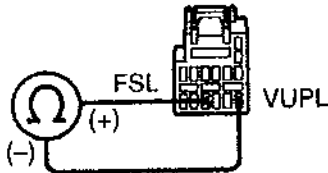
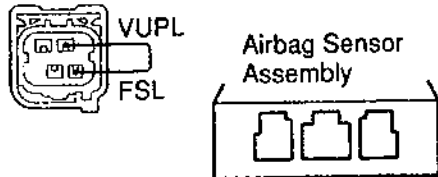
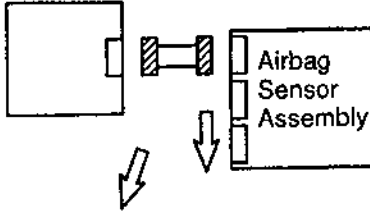
Side Airbag Sensor
Assembly (LH)H01010
H01059
H01051

H01167

PREPARATION:

Using a service wire, connect VUPL and FSL of the connector (on the side airbag sensor assembly side) between the side airbag sensor assembly (LH) and the airbag sensor assembly.

CHECK:

For the connector (on the airbag sensor assembly side) between the side airbag sensor assembly (LH) and the airbag sensor assembly, measure the resistance between VUPL and FSL.

OK:

Resistance: Below 1 Ω

NG

Repair or replace harness or connector between side airbag sensor assembly (LH) and airbag sensor assembly.

OK

6 Check wire harness (to ground).

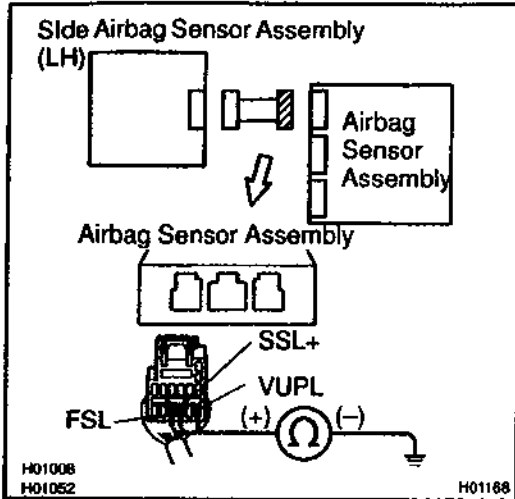

CHECK:

For the connector (on the airbag sensor assembly side) between the side airbag sensor assembly (LH) and the airbag sensor assembly, measure the resistance between body ground and each of SSL+, VUPL and FSL.

OK:

Resistance: 1 MΩ or Higher



Repair or replace harness or connector between side airbag sensor assembly (LH) and airbag sensor assembly.



7 Check wire harness (to B+).

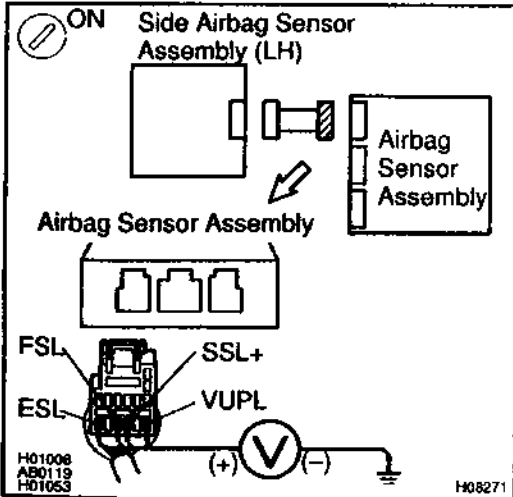

CHECK:

- (a) Turn ignition switch to ON.
- (b) For the connector (on the airbag sensor assembly side) between the side airbag sensor assembly (LH) and the airbag sensor assembly, measure the voltage between body ground and each of SSL+, ESL, VUPL and FSL.

OK:

Voltage: 0 V



Repair or replace harness or connector between side airbag sensor assembly (LH) and airbag sensor assembly.



8 Is DTC B1141/33 out put again?

Side Airbag Sensor Assembly (LH)

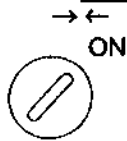
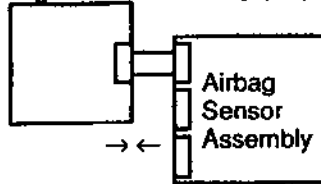

DLC3

DTC B1141/33

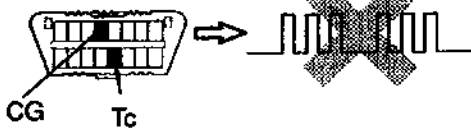

H01007
AB0119
H10800 H01086

H12033

PREPARATION:

- Connect the connector to the side airbag sensor assembly (LH).
- Connect the connector to the airbag sensor assembly.
- Connect negative (-) terminal cable to the battery, and wait at least for 2 seconds.

CHECK:

- Turn the ignition switch to ON, and wait at least for 20 seconds.
- Clear the DTC stored in memory (See step 5 on page DI-326).
- Turn the ignition switch to LOCK, and wait at least for 20 seconds.
- Turn the ignition switch to ON, and wait at least for 20 seconds.
- Check the DTC (See page DI-326).

OK:

DTC B1141/33 is not output.

HINT:

Codes other than code B1141/33 may be output at this time, but they are not relevant to this check.

NO

Go to step 9.

YES

From the results of the above inspection, the malfunctioning part can now be considered normal. To make sure of this, use the simulation method to check.

9 Check airbag sensor assembly.

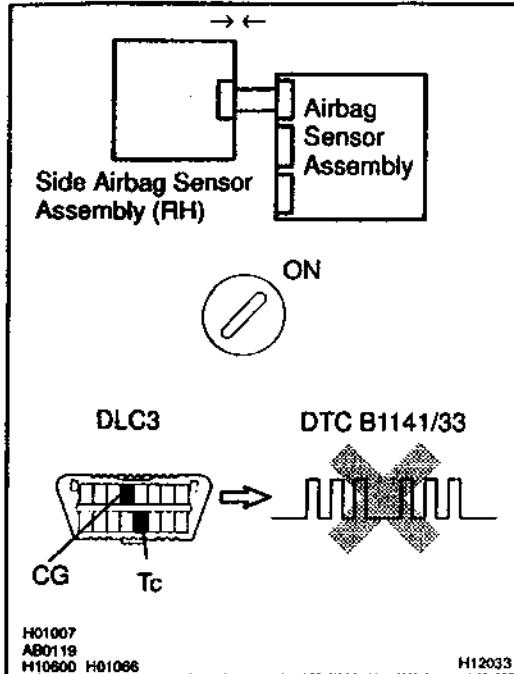

PREPARATION:

- Turn the ignition switch to LOCK.
- Disconnect negative (-) terminal cable from the battery, and wait at least for 90 seconds.
- Disconnect the side airbag sensor (LH) from the connector and connect the side airbag sensor (RH) to the connector.
- Connect negative (-) terminal cable to the battery, and wait at least for 2 seconds.

CHECK:

- Turn the ignition switch to ON, and wait at least for 20 seconds.
- Clear the DTC stored in memory (See step 5 on page DI-326).
- Turn the ignition switch to LOCK, and wait at least for 20 seconds.
- Turn the ignition switch to ON, and wait at least for 20 seconds.
- Check the DTC (See page DI-326).

OK:

DTC B1141/33 is not output.

HINT:

Codes other than code B1141/33 may be output at this time, but they are not relevant to this check.

NG

Replace airbag sensor assembly.

OK

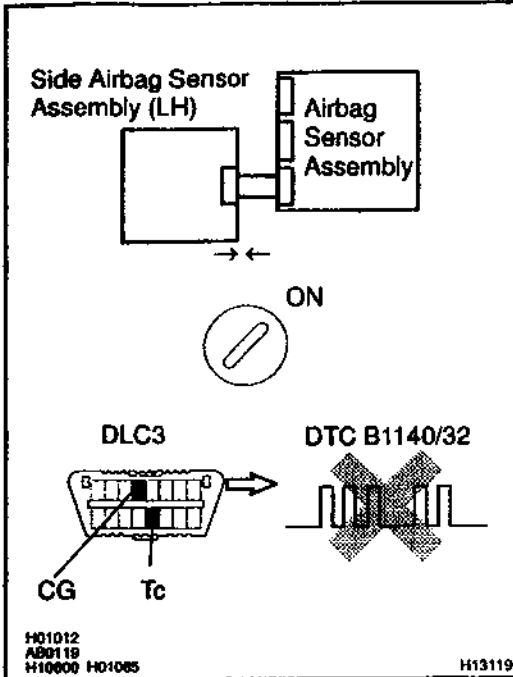
10 Check side airbag sensor assembly (LH).**PREPARATION:**

- Turn the ignition switch to LOCK.
- Disconnect negative (-) terminal cable from the battery, and wait at least for 90 seconds.
- Connect the side airbag sensor (LH) to the connector that the side airbag sensor (RH) was connected to.
- Connect negative (-) terminal cable to the battery, and wait at least for 2 seconds.

CHECK:

- Turn the ignition switch to ON, and wait at least for 20 seconds.
- Clear the DTC stored in memory (See step 5 on page DI-326).
- Turn the ignition switch to LOCK, and wait at least for 20 seconds.
- Turn the ignition switch to ON, and wait at least for 20 seconds.
- Check the DTC (See page DI-326).

OK:

DTC B1140/32 is not output.

HINT:

Codes other than code B1140/32 may be output at this time, but they are not relevant to this check.

NG

Replace side airbag sensor assembly (LH).

OK

From the results of the above inspection, the malfunctioning part can now be considered normal. To make sure of this, use the simulation method to check.

DTC	B1142/B1143/34	Door Side Airbag Sensor (RH) Malfunction
------------	-----------------------	-------------------------------------------------

CIRCUIT DESCRIPTION

The door side airbag sensor (RH) circuit consists of the airbag sensor assembly and door side airbag sensor (RH).

For details of the function of each component, see OPERATION on page RS-2.

DTC B1142/B1143/34 is recorded when a malfunction is detected in the door side airbag sensor (RH) circuit.

DTC No.	DTC Detecting Condition	Trouble Area
B1142/B1143/34	• Door side airbag sensor (RH) malfunction	<ul style="list-style-type: none"> • Door side airbag sensor (RH) • Airbag sensor assembly • Instrument panel wire harness • RH front door wire harness

WIRING DIAGRAM

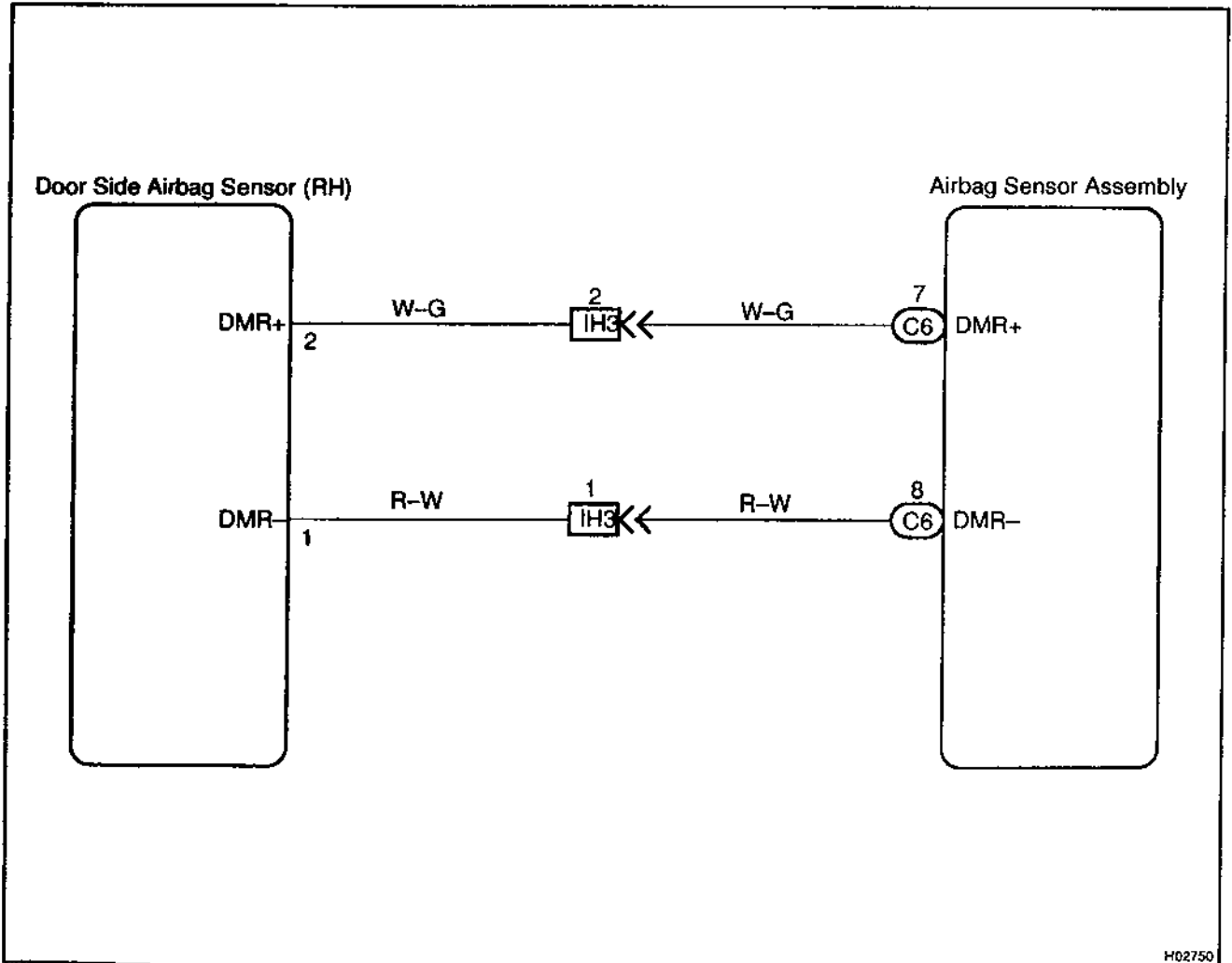

INSPECTION PROCEDURE

1 Prepare for inspection (See step 1 on page DI-471).

2 Check wire harness (to B+).

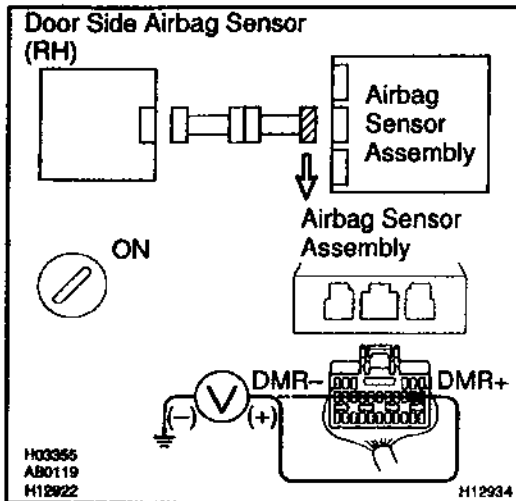
**CHECK:**

- Turn the ignition switch to ON.
- For the connector (on the airbag sensor assembly side) between the door side airbag sensor (RH) and the airbag sensor assembly, measure the voltage between body ground and each of DMR+ and DMR-.

OK:

Voltage: Below 1 V

NG

Go to step 8.

OK

3 Check wire harness (to ground).

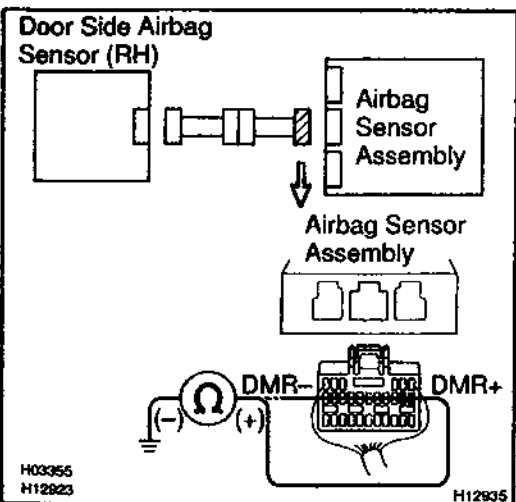
**CHECK:**

For the connector (on the airbag sensor assembly side) between the door side airbag sensor (RH) and the airbag sensor assembly, measure the resistance between body ground and each of DMR+ and DMR-.

OK:

Resistance: 1 MΩ or Higher

NG

Go to step 9.

OK

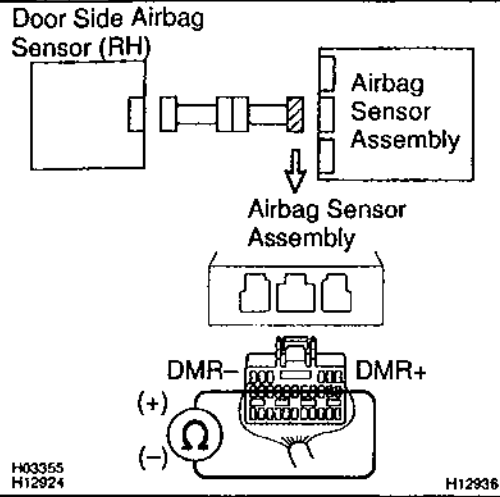
4 Check wire harness.**CHECK:**

For the connector (on the airbag sensor assembly side) between the door side airbag sensor (RH) and the airbag sensor assembly, measure the resistance between DMR+ and DMR-.

OK:

Resistance: 1 M Ω or Higher

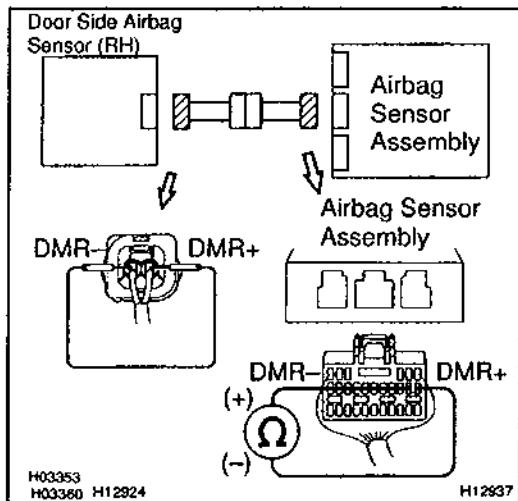
NG**Go to step 10.****OK****5 Check wire harness.****PREPARATION:**

Using a service wire, connect DMR+ and DMR- of the connector (on the door side airbag sensor (RH) side) between the airbag sensor assembly and the door side airbag sensor (RH).

CHECK:

For the connector (on the airbag sensor assembly side) between the door side airbag sensor (RH) and the airbag sensor assembly, measure the resistance between DMR+ and DMR-.

OK:

Resistance: Below 1 Ω

NG**Go to step 11.****OK**

6 Check door side airbag sensor (RH).

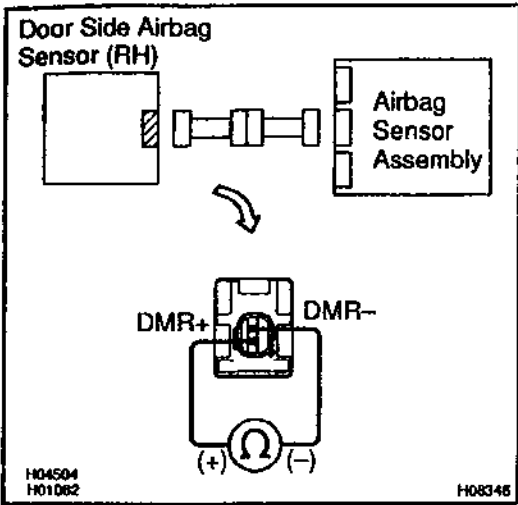

CHECK:
For the connector of the door side airbag sensor (RH), measure the resistance between DMR+ and DMR-.

OK:
Resistance: 300 – 1500 Ω

OK

NG Replace door side airbag sensor (RH).

7 Check airbag sensor assembly.

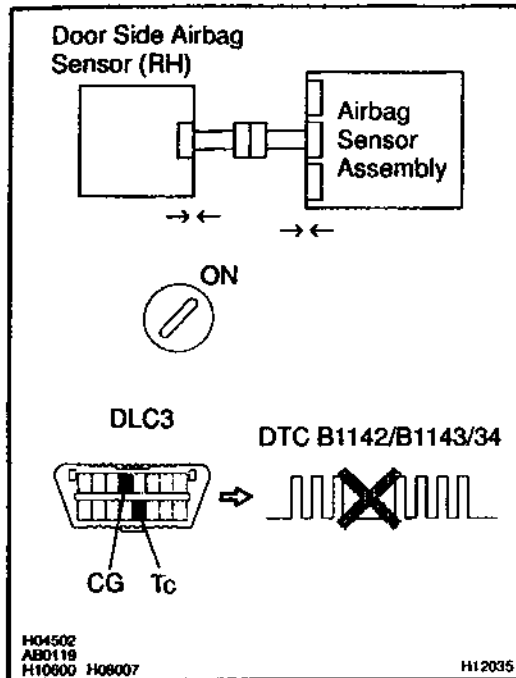

PREPARATION:

- Turn the ignition switch to LOCK.
- Disconnect negative (-) terminal cable from the battery, and wait at least for 90 seconds.
- Connect the door side airbag sensor (RH) connector and airbag sensor assembly connector.
- Connect negative (-) terminal cable to the battery, and wait at least for 2 seconds.

CHECK:

- Turn the ignition switch to ON, and wait at least for 20 seconds.
- Clear the DTC stored in memory (See page DI-326).
- Turn the ignition switch to LOCK, and wait at least for 20 seconds.
- Turn the ignition switch to ON, and wait at least for 20 seconds.
- Check the DTC (See page DI-326).

OK:

DTC 34 is not output.

HINT:

Codes other than code 34 may be output at this time, but they are not relevant to this check.

NG

Replace airbag sensor assembly.

OK

From the results of the above inspection, the malfunctioning part can now be considered normal. To make sure of this, use the simulation method to check.

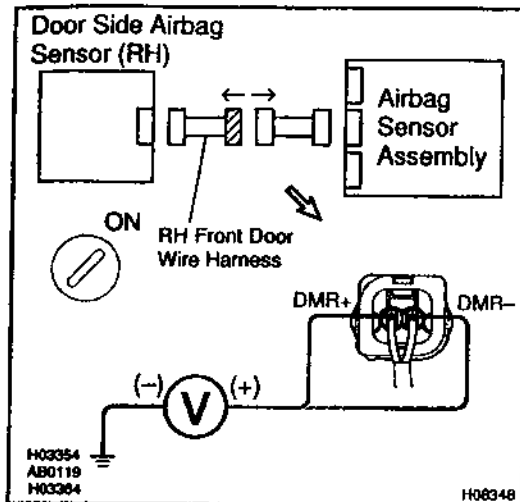
8 Check RH front door wire harness (to B+).**PREPARATION:**

Disconnect the RH front door wire harness connector on the airbag sensor assembly side.

CHECK:

- Turn the ignition switch to ON.
- For the connector (on the RH front door wire harness side) between the airbag sensor assembly and the RH front door wire harness, measure the voltage between body ground and each of DMR+ and DMR-.

OK:

Voltage: Below 1 V

NG

Repair or replace RH front door wire harness.

OK

Repair or replace harness or connector between airbag sensor assembly and RH front door wire harness.

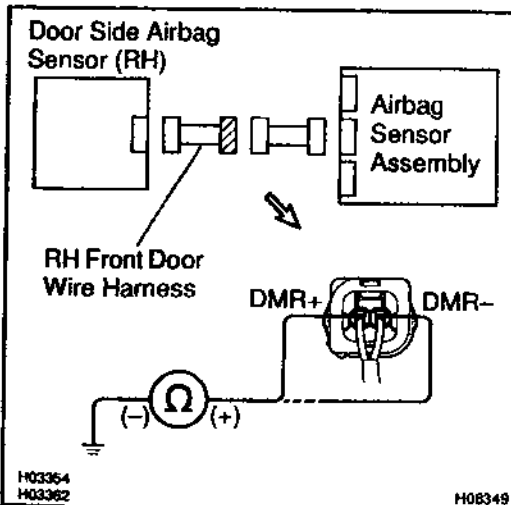
9 Check RH front door wire harness (to ground).**PREPARATION:**

Disconnect the RH front door wire harness connector on the airbag sensor assembly side.

CHECK:

For the connector (on the RH front door wire harness side) between the airbag sensor assembly and the RH front door wire harness, measure the resistance between body ground and each of DMR+ and DMR-.

OK:

Resistance: 1 MΩ or Higher

NG

Repair or replace RH front door wire harness.

OK

Repair or replace harness or connector between airbag sensor assembly and RH front door wire harness.

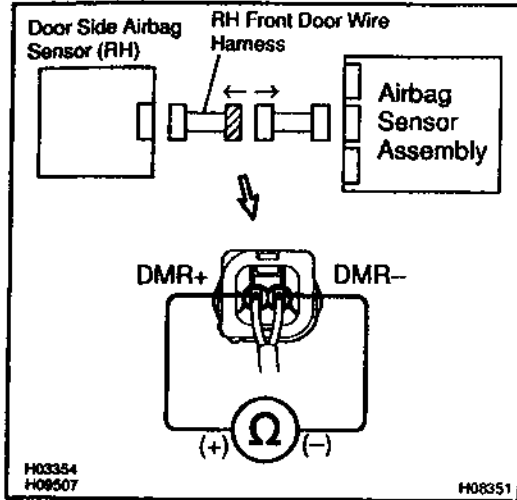
10 Check RH front door wire harness.**PREPARATION:**

Disconnect the RH front door wire harness connector on the airbag sensor assembly side.

CHECK:

For the connector (on the RH front door wire harness side) between the airbag sensor assembly and the RH front door wire harness, measure the resistance between DMR+ and DMR-.

OK:

Resistance: 1 M Ω or Higher

NG**Repair or replace RH front door wire harness.****OK**

Repair or replace harness or connector between airbag sensor assembly and RH front door wire harness.

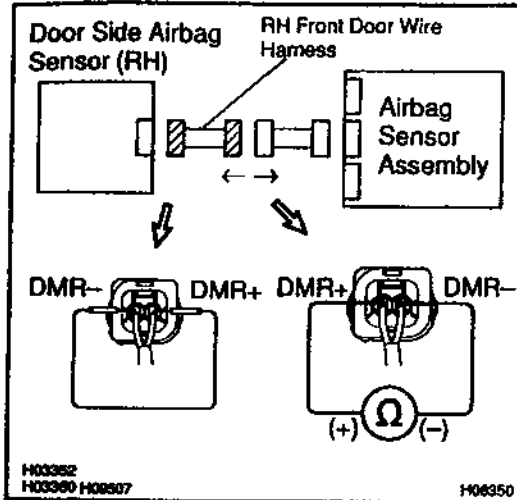
11 Check RH front door wire harness.

PREPARATION:

- Disconnect the RH front door wire harness connector on the airbag sensor assembly side.
- Using a service wire, connect DMR+ and DMR- of the connector (on the RH front door wire harness side) between the RH front door wire harness and the door side airbag sensor (RH).

CHECK:

For the connector (on the RH front door wire harness side) between the airbag sensor assembly and the RH front door wire harness, measure the resistance between DMR+ and DMR-.

OK:

Resistance: Below 1 Ω

NG
Repair or replace RH front door wire harness.
OK
Repair or replace harness or connector between airbag sensor assembly and RH front door wire harness.

DTC	B1144/B1145/35	Door Side Airbag Sensor (LH) Malfunction
------------	-----------------------	-------------------------------------------------

CIRCUIT DESCRIPTION

The door side airbag sensor (LH) circuit consists of the airbag sensor assembly and door side airbag sensor (LH).

For details of the function of each component, see OPERATION on page RS-2.

DTC B1144/B1145/35 is recorded when malfunction is detected in the door side airbag sensor (LH) circuit.

DTC No.	DTC Detecting Condition	Trouble Area
B1144/B1145/35	• Door side airbag sensor (LH) malfunction	<ul style="list-style-type: none"> • Door side airbag sensor (LH) • Airbag sensor assembly • Instrument panel wire harness • LH front door wire harness

WIRING DIAGRAM

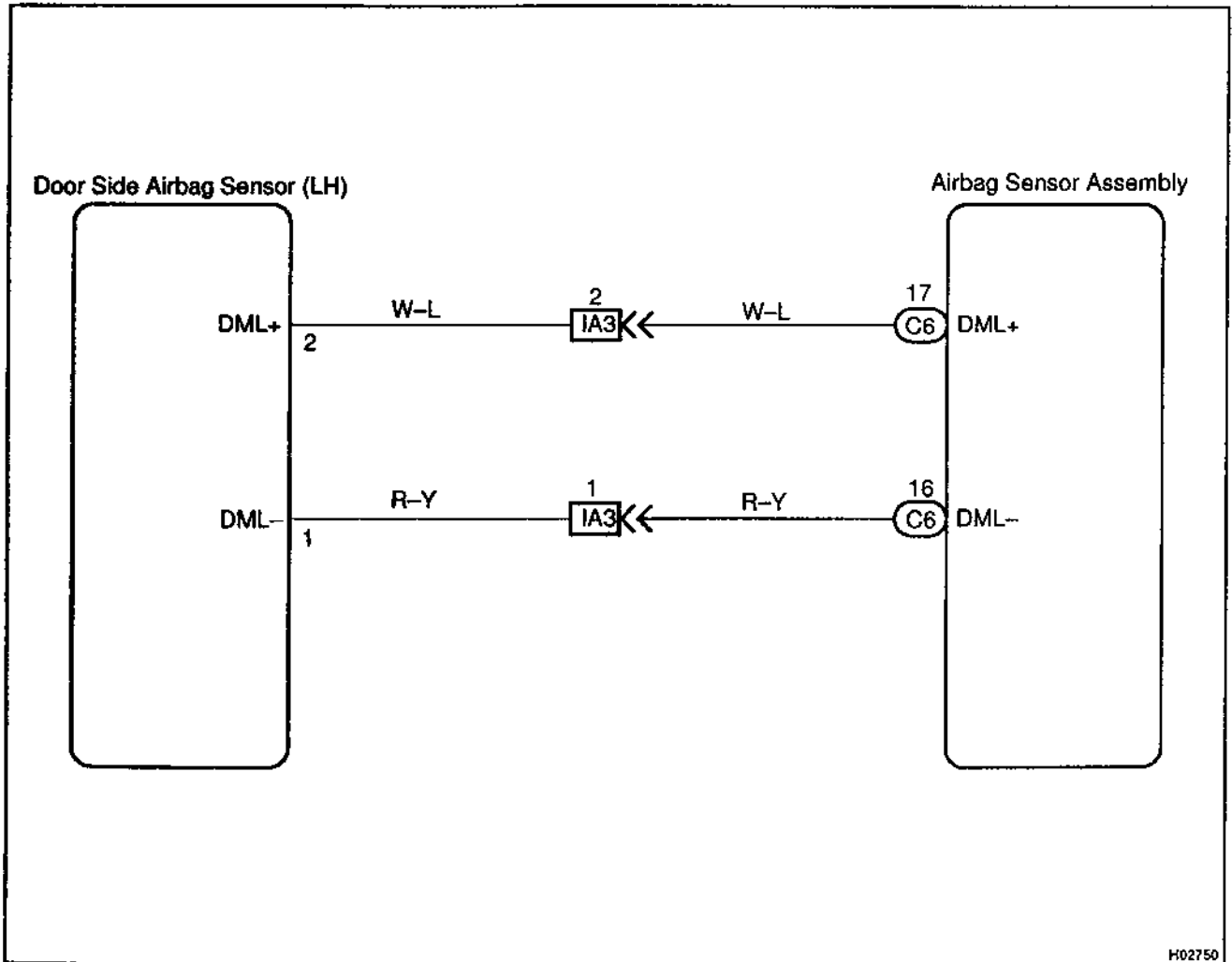

INSPECTION PROCEDURE

1 Prepare for inspection (See step 1 on page DI-471).

2 Check wire harness (to B+).

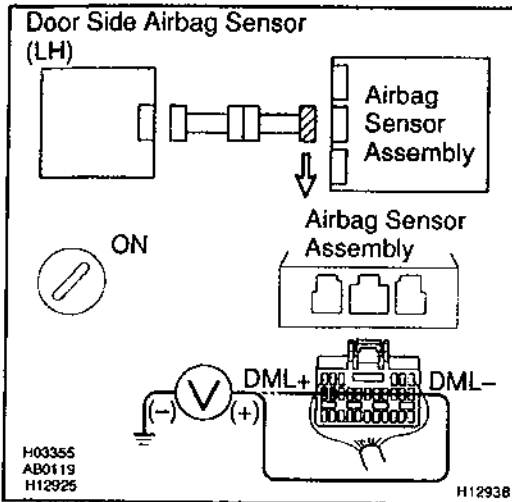
**CHECK:**

- Turn the ignition switch to ON.
- For the connector (on the airbag sensor assembly side) between the door side airbag sensor (LH) and the airbag sensor assembly, measure the voltage between body ground and each of DML+ and DML-.

OK:

Voltage: Below 1 V

NG

Go to step 8.

OK

3 Check wire harness (to ground).

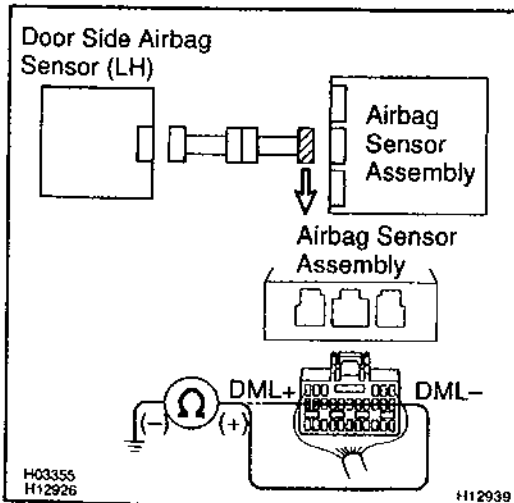
**CHECK:**

For the connector (on the airbag sensor assembly side) between the door side airbag sensor (LH) and the airbag sensor assembly, measure the resistance between body ground and each of DML+ and DML-.

OK:

Resistance: 1 MΩ or Higher

NG

Go to step 9.

OK

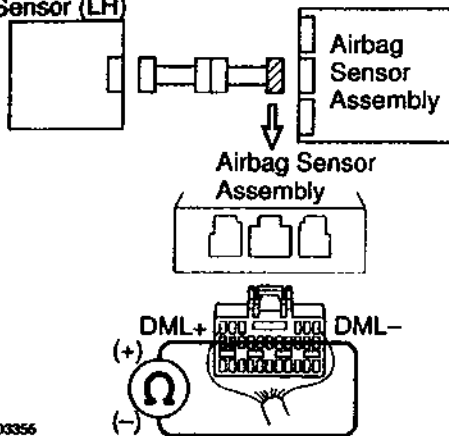
4 Check wire harness.Door Side Airbag
Sensor (LH)**CHECK:**

For the connector (on the airbag sensor assembly side) between the door side airbag sensor (LH) and the airbag sensor assembly, measure the resistance between DML+ and DML-.

OK:

Resistance: 1 M Ω or Higher

NG

Go to step 10.

OK

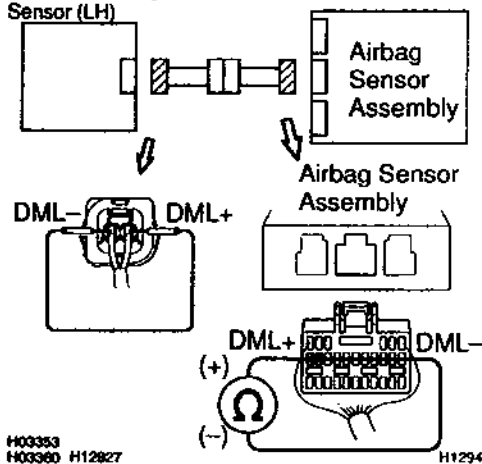
5 Check wire harness.Door Side Airbag
Sensor (LH)**PREPARATION:**

Using a service wire, connect DML+ and DML- of the connector (on the door side airbag sensor (LH) side) between the airbag sensor assembly and the door side airbag sensor (LH).

CHECK:

For the connector (on the airbag sensor assembly side) between the door side airbag sensor (LH) and the airbag sensor assembly, measure the resistance between DML+ and DML-.

OK:

Resistance: Below 1 Ω

NG

Go to step 11.

OK

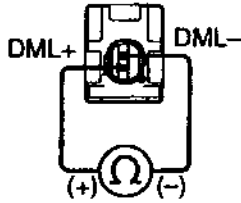
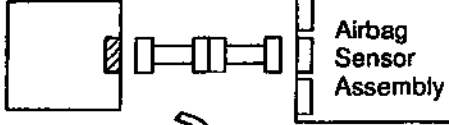
6 Check door side airbag sensor (LH).Door Side Airbag
Sensor (LH)H04504
H01062

H08346

CHECK:

For the connector of the door side airbag sensor (LH), measure the resistance between DML+ and DML-.

OK:**Resistance: 300 – 1500 Ω****NG****Replace door side airbag sensor (LH).****OK**

7 Check airbag sensor assembly.

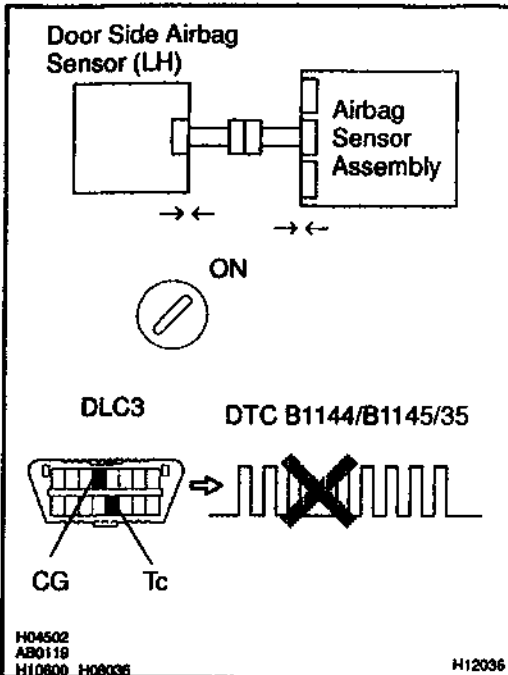

PREPARATION:

- Turn the ignition switch to LOCK.
- Disconnect negative (-) terminal cable from the battery, and wait at least for 90 seconds.
- Connect the door side airbag sensor (LH) connector and airbag sensor assembly connector.
- Connect negative (-) terminal cable to the battery, and wait at least for 2 seconds.

CHECK:

- Turn the ignition switch to ON, and wait at least for 20 seconds.
- Clear the DTC stored in memory (See page DI-326).
- Turn the ignition switch to LOCK, and wait at least for 20 seconds.
- Turn the ignition switch to ON, and wait at least for 20 seconds.
- Check the DTC (See page DI-326).

OK:

DTC 35 is not output.

HINT:

Codes other than code 35 may be output at this time, but they are not relevant to this check.

NG

Replace airbag sensor assembly.

OK

From the results of the above inspection, the malfunctioning part can now be considered normal. To make sure of this, use the simulation method to check.

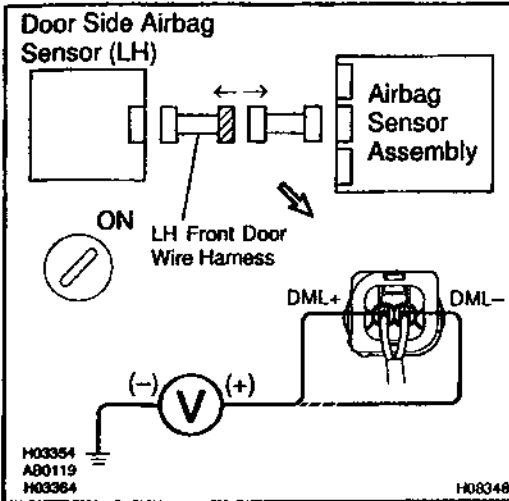
8 Check LH front door wire harness (to B+).

OK

PREPARATION:

Disconnect the LH front door wire harness connector on the airbag sensor assembly side.

CHECK:

- Turn the Ignition switch to ON.
- For the connector (on the LH front door wire harness side) between the airbag sensor assembly and the LH front door wire harness, measure the voltage between body ground and each of DML+ and DML-.

OK:

Voltage: Below 1 V

NG

Repair or replace LH front door wire harness.

Repair or replace harness or connector between airbag sensor assembly and LH front door wire harness.

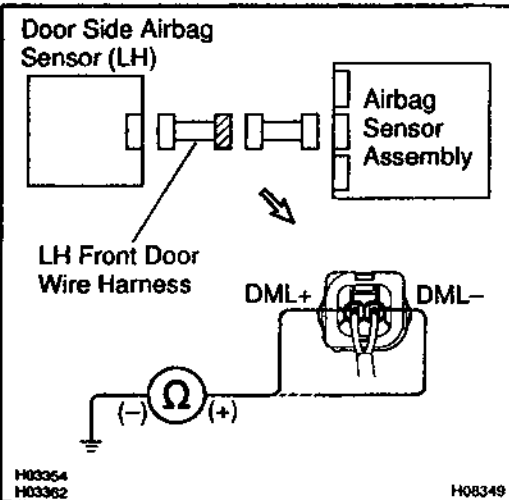
9 Check LH front door wire harness (to ground).

OK

PREPARATION:

Disconnect the LH front door wire harness connector on the airbag sensor assembly side.

CHECK:

For the connector (on the LH front door wire harness side) between the airbag sensor assembly and the LH front door wire harness, measure the resistance between body ground and each of DML+ and DML-.

OK:

Resistance: 1 MΩ or Higher

NG

Repair or replace LH front door wire harness.

Repair or replace harness or connector between airbag sensor assembly and LH front door wire harness.

10

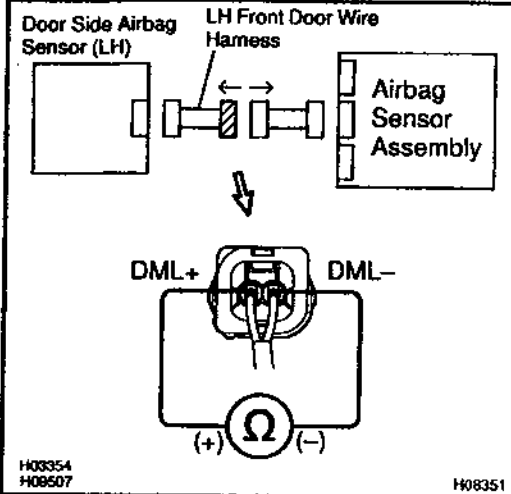
Check LH front door wire harness.**PREPARATION:**

Disconnect the LH front door wire harness connector on the airbag sensor assembly side.

CHECK:

For the connector (on the LH front door wire harness side) between the airbag sensor assembly and the LH front door wire harness, measure the resistance between DML+ and DML-.

OK:

Resistance: 1 M Ω or Higher

NG

Repair or replace LH front door wire harness.

OK

Repair or replace harness or connector between airbag sensor assembly and LH front door wire harness.

11

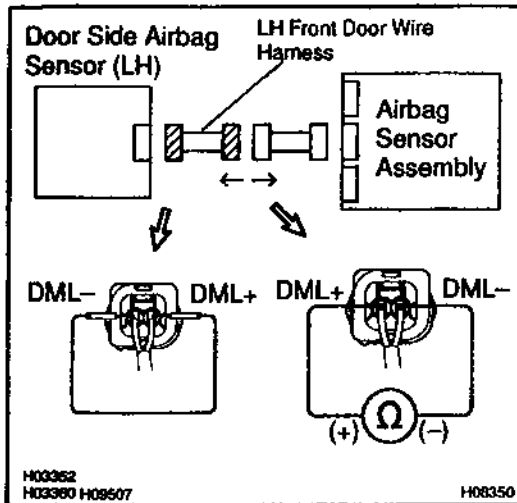
Check LH front door wire harness.**PREPARATION:**

- Disconnect the LH front door wire harness connector on the airbag sensor assembly side.
- Using a service wire, connect DML+ and DML- of the connector (on the LH front door wire harness side) between the LH front door wire harness and the door side airbag sensor (LH).

CHECK:

For the connector (on the LH front door wire harness side) between the airbag sensor assembly and the LH front door wire harness, measure the resistance between DML+ and DML-.

OK:

Resistance: Below 1 Ω

NG

Repair or replace LH front door wire harness.

OK

Repair or replace harness or connector between airbag sensor assembly and LH front door wire harness.

DTC	B1156/B1157/15	Front Airbag Sensor (RH) Malfunction
------------	-----------------------	---------------------------------------------

CIRCUIT DESCRIPTION

The front airbag sensor (RH) circuit consists of the airbag sensor assembly and front airbag sensor (RH). For details of the function of each component, see OPERATION on page RS-2.

DTC B1156/B1157/15 is recorded when a malfunction is detected in the front airbag sensor (RH) circuit.

DTC No.	DTC Detecting Condition	Trouble Area
B1156/B1157/15	• Front airbag sensor (RH) malfunction	<ul style="list-style-type: none"> • Front airbag sensor (RH) • Airbag sensor assembly • Wire harness • Engine room No. 2 wire harness

WIRING DIAGRAM

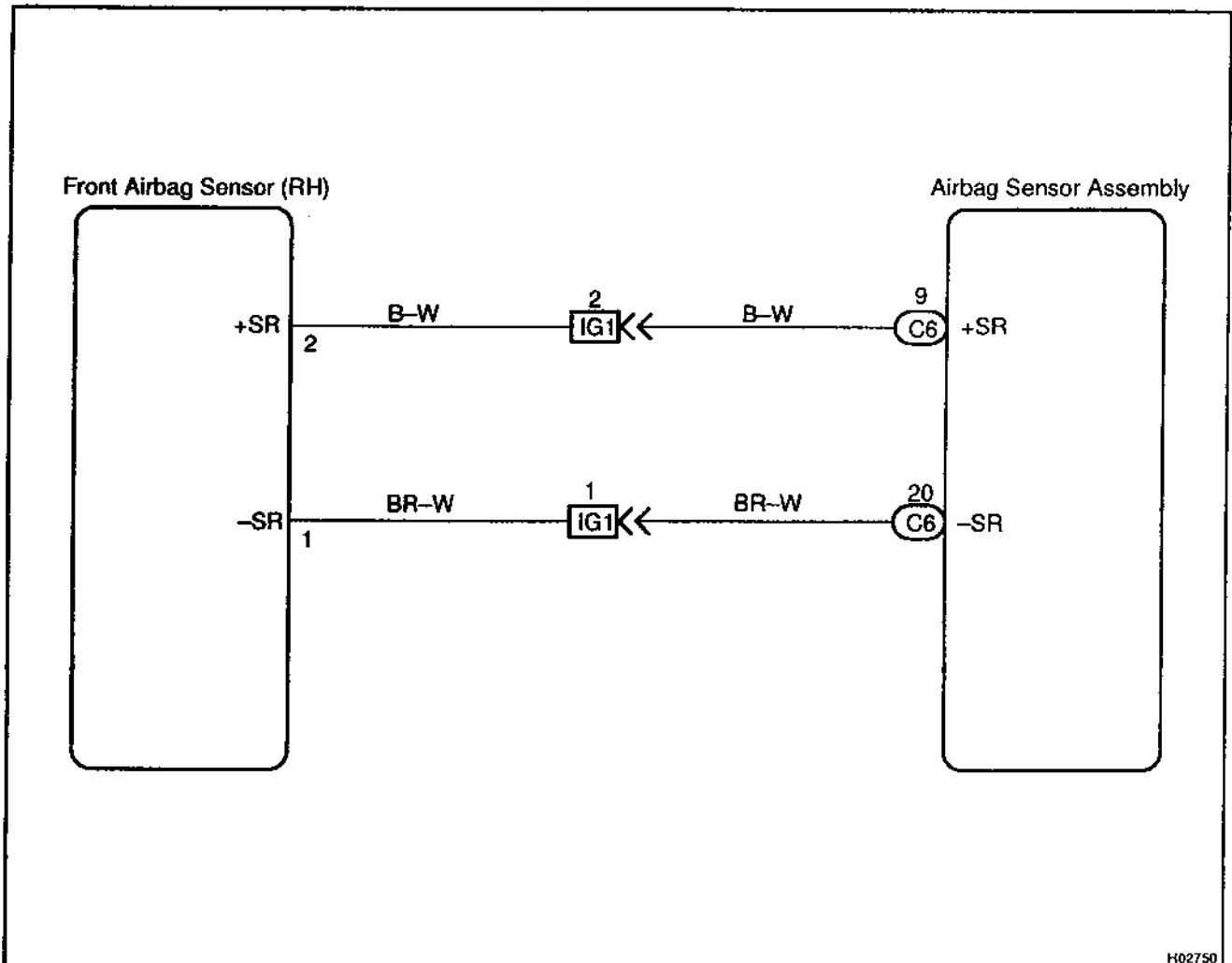

INSPECTION PROCEDURE

1 Prepare for inspection (See step 1 on page DI-471).

2 Check wire harness (to B+).

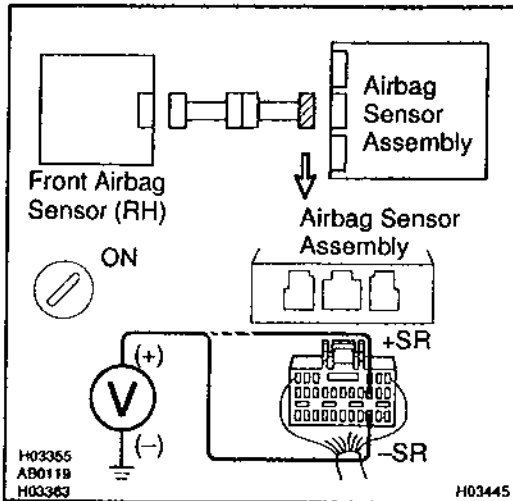
**CHECK:**

- Turn the ignition switch to ON.
- For the connector (on the airbag sensor assembly side) between the front airbag sensor (RH) and the airbag sensor assembly, measure the voltage between body ground and each of +SR and -SR.

OK:

Voltage: Below 1 V

NG

Go to step 8.

OK

3 Check wire harness (to ground).

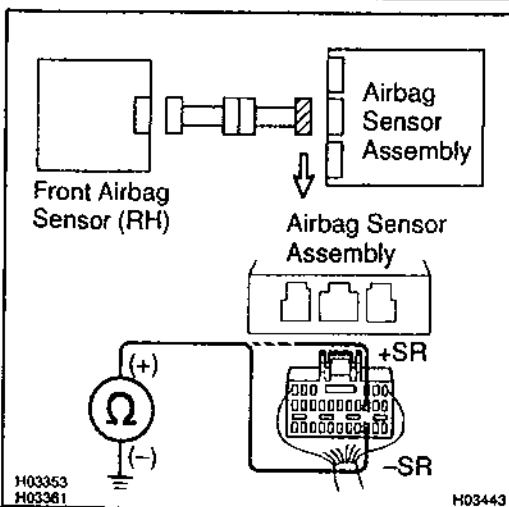
**CHECK:**

For the connector (on the airbag sensor assembly side) between the front airbag sensor (RH) and the airbag sensor assembly, measure the resistance between body ground and each of +SR and -SR.

OK:

Resistance: 1 MΩ or Higher

NG

Go to step 9.

OK

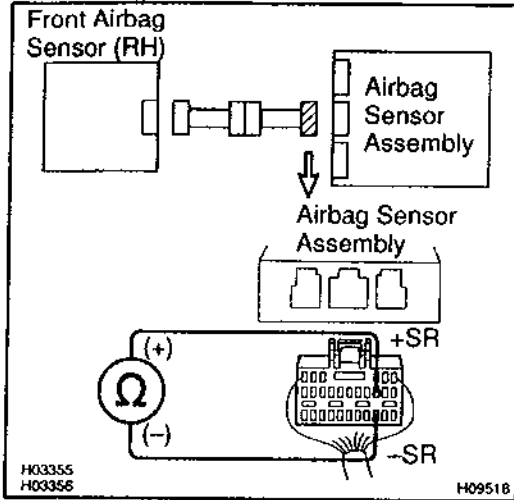
4 Check wire harness.**CHECK:**

For the connector (on the airbag sensor assembly side) between the front airbag sensor (RH) and the airbag sensor assembly, measure the resistance between +SR and -SR.

OK:

Resistance: 1 M Ω or Higher

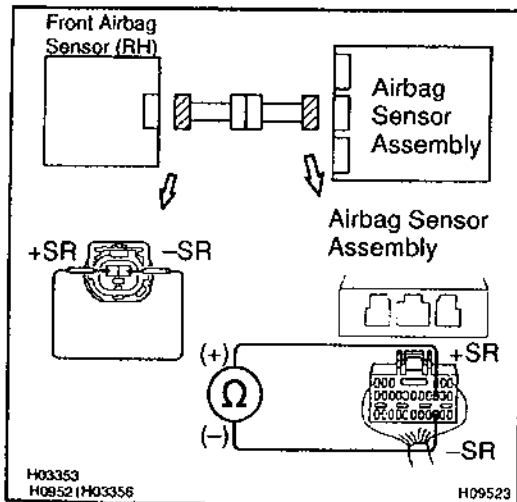
NG**Go to step 10.****OK****5 Check wire harness.****PREPARATION:**

Using a service wire, connect +SR and -SR of the connector (on the front airbag sensor (RH) side) between the airbag sensor assembly and the front airbag sensor (RH).

CHECK:

For the connector (on the airbag sensor assembly side) between the front airbag sensor (RH) and the airbag sensor assembly, measure the resistance between +SR and -SR.

OK:

Resistance: Below 1 Ω

NG**Go to step 11.****OK**

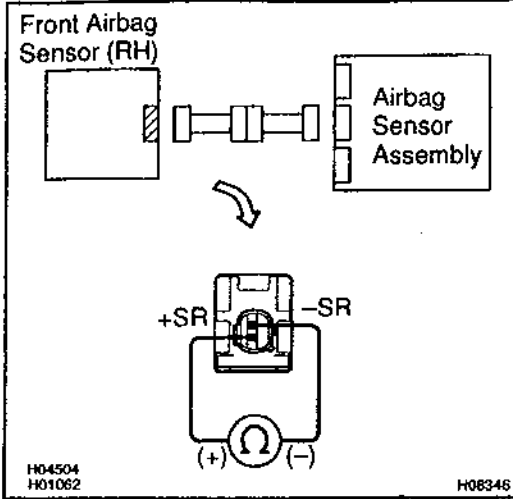
6 Check front airbag sensor (RH).**CHECK:**

For the connector of the front airbag sensor (RH), measure the resistance between +SR and -SR.

OK:

Resistance: 300 – 1500 Ω

NG**Replace front airbag sensor (RH).****OK**

7 Check airbag sensor assembly.

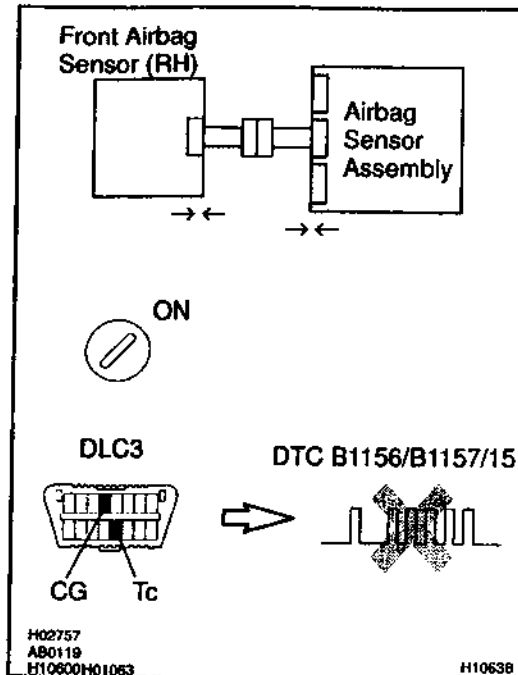

PREPARATION:

- Turn the ignition switch to LOCK.
- Disconnect negative (-) terminal cable from the battery, and wait at least for 90 seconds.
- Connect the front airbag sensor (RH) connector and airbag sensor assembly connector.
- Connect negative (-) terminal cable to the battery, and wait at least for 2 seconds.

CHECK:

- Turn the ignition switch to ON, and wait at least for 20 seconds.
- Clear the DTC stored in memory (See page DI-326).
- Turn the ignition switch to LOCK, and wait at least for 20 seconds.
- Turn the ignition switch to ON, and wait at least for 20 seconds.
- Check the DTC (See page DI-326).

OK:

DTC B1156/B1157/15 is not output.

HINT:

Codes other than code B1156/B1157/15 may be output at this time, but they are not relevant to this check.

NG

Replace airbag sensor assembly.

OK

From the results of the above inspection, the malfunctioning part can now be considered normal. To make sure of this, use the simulation method to check.

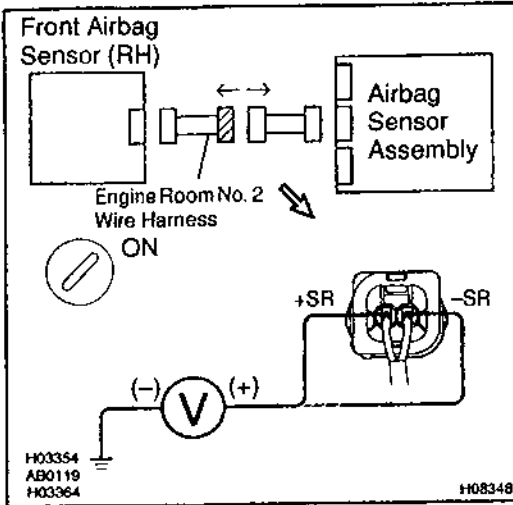
8 Check engine room No. 2 wire harness (to B+).**PREPARATION:**

Disconnect the engine room No. 2 wire harness connector on the airbag sensor assembly side.

CHECK:

- Turn the ignition switch to ON.
- For the connector (on the RH front door wire harness side) between the airbag sensor assembly and the engine room No. 2 wire harness, measure the voltage between body ground and each of +SR and -SR.

OK:

Voltage: Below 1 V

NG

Repair or replace engine room No. 2 wire harness.

OK

Repair or replace harness or connector between airbag sensor assembly and engine room No. 2 wire harness.

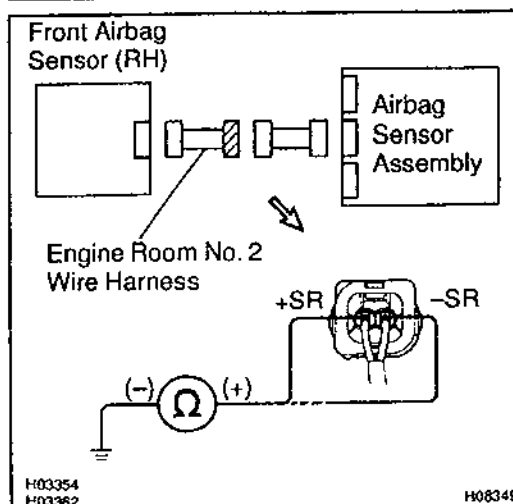
9 Check engine room No. 2 wire harness (to ground).**PREPARATION:**

Disconnect the engine room No. 2 wire harness connector on the airbag sensor assembly side.

CHECK:

For the connector (on the engine room No. 2 wire harness side) between the airbag sensor assembly and the engine room No. 2 wire harness, measure the resistance between body ground and each of +SR and -SR.

OK:

Resistance: 1 MΩ or Higher

NG

Repair or replace engine room No. 2 wire harness.

OK

Repair or replace harness or connector between airbag sensor assembly and engine room No. 2 wire harness.

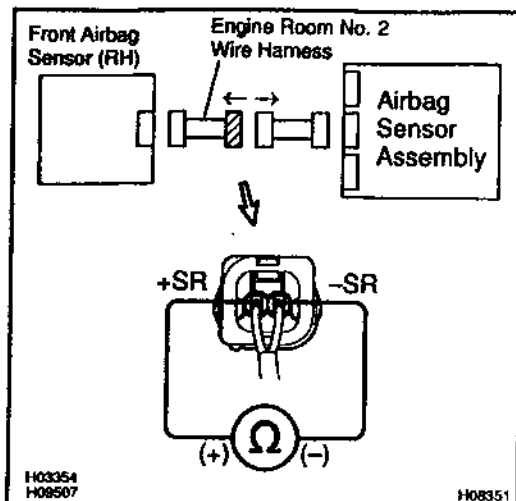
10 Check engine room No. 2 wire harness.**PREPARATION:**

Disconnect the engine room No. 2 wire harness connector on the airbag sensor assembly side.

CHECK:

For the connector (on the engine room No. 2 wire harness side) between the airbag sensor assembly and the engine room No. 2 wire harness, measure the resistance between +SR and -SR.

OK:

Resistance: 1 MΩ or Higher

NG

Repair or replace engine room No. 2 wire harness.

OK

Repair or replace harness or connector between airbag sensor assembly and engine room No. 2 wire harness.

11

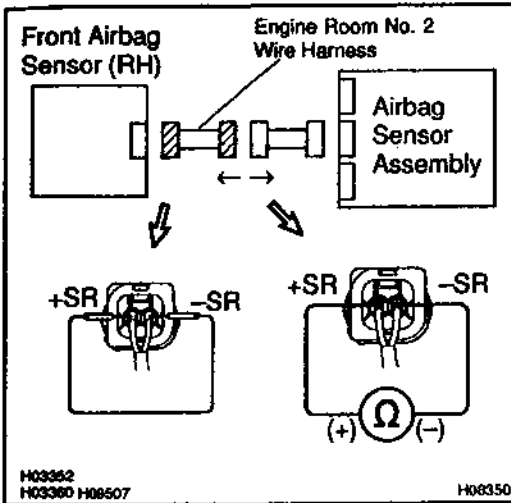
Check engine room No. 2 wire harness.**PREPARATION:**

- Disconnect the engine room No. 2 wire harness connector on the airbag sensor assembly side.
- Using a service wire, connect +SR and -SR of the connector (on the engine room No. 2 wire harness side) between the engine room No. 2 wire harness and the front airbag sensor (RH).

CHECK:

For the connector (on the engine room No. 2 wire harness side) between the airbag sensor assembly and the engine room No. 2 wire harness, measure the resistance between +SR and -SR.

OK:

Resistance: Below 1 Ω

NG

Repair or replace engine room No. 2 wire harness.

OK

Repair or replace harness or connector between airbag sensor assembly and engine room No. 2 wire harness.

DTC	B1158/B1159/16	Front Airbag Sensor (LH) Malfunction
------------	-----------------------	---------------------------------------------

CIRCUIT DESCRIPTION

The front airbag sensor (LH) circuit consists of the airbag sensor assembly and front airbag sensor (LH). For details of the function of each component, see OPERATION on page RS-2.

DTC B1158/B1159/16 is recorded when malfunction is detected in the front airbag sensor (LH) circuit.

DTC No.	DTC Detecting Condition	Trouble Area
B1158/B1159/16	• Front airbag sensor (LH) malfunction	<ul style="list-style-type: none"> • Front airbag sensor (LH) • Airbag sensor assembly • Wire harness • Engine room main wire harness

WIRING DIAGRAM

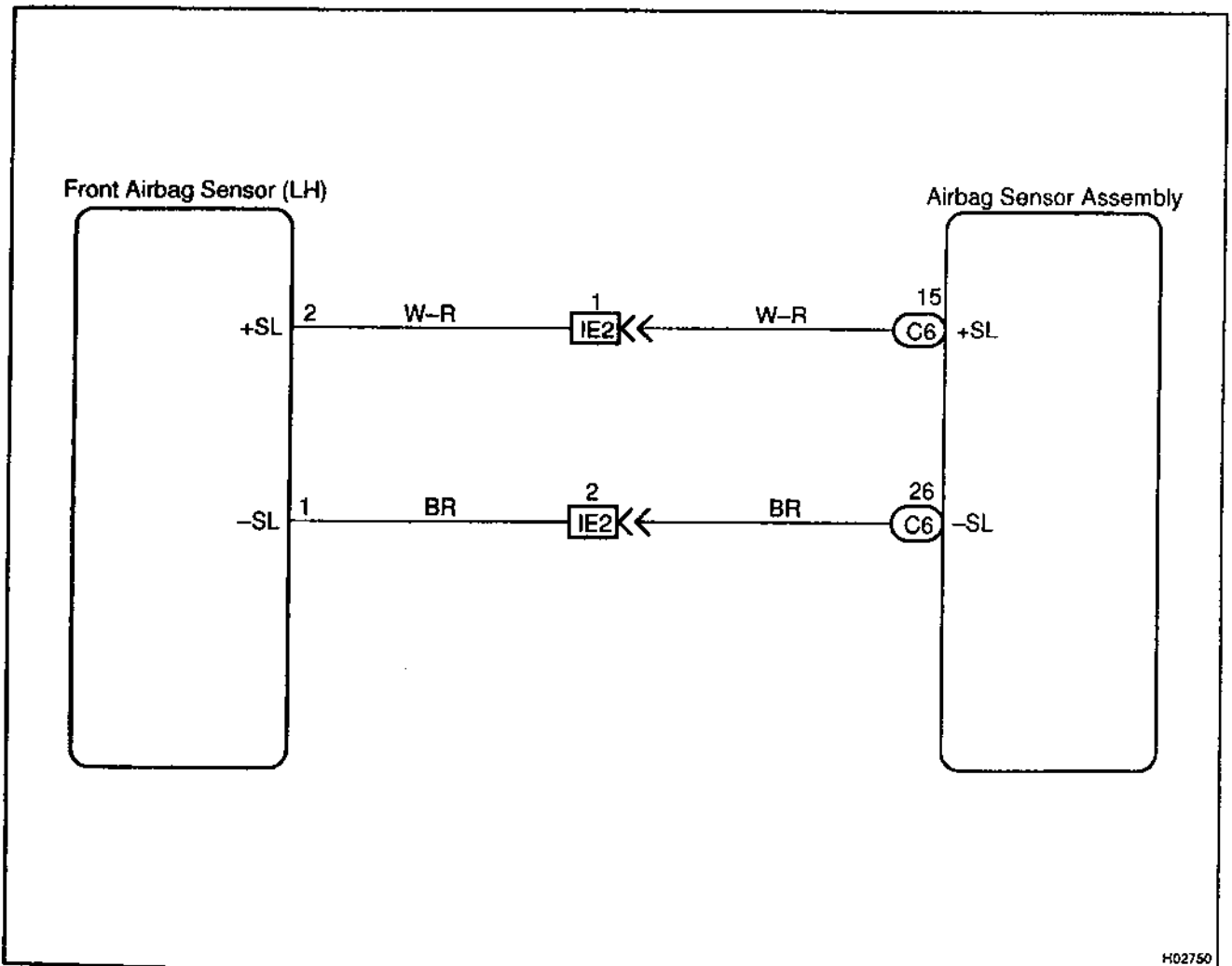

INSPECTION PROCEDURE

1 Prepare for inspection (See step 1 on page DI-471).

2 Check wire harness (to B+).

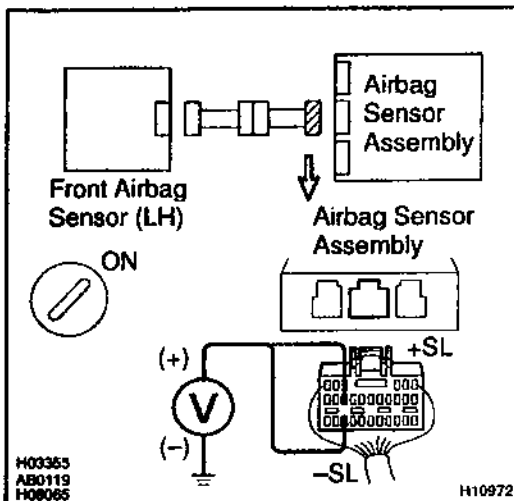
**CHECK:**

- (a) Turn the ignition switch to ON.
- (b) For the connector (on the airbag sensor assembly side) between the front airbag sensor (LH) and the airbag sensor assembly, measure the voltage between body ground and each of +SL and -SL.

OK:

Voltage: Below 1 V

NG

Go to step 8.

OK

3 Check wire harness (to ground).

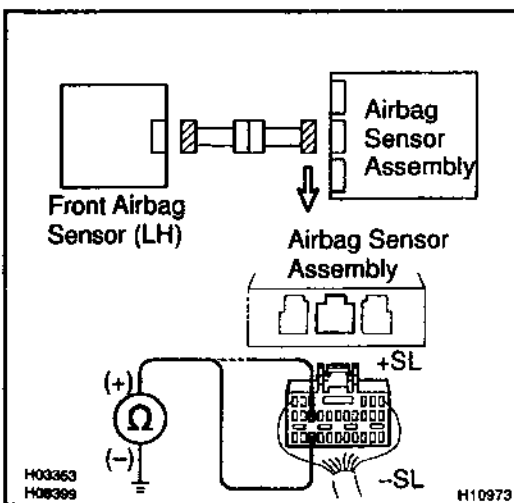
**CHECK:**

For the connector (on the airbag sensor assembly side) between the front airbag sensor (LH) and the airbag sensor assembly, measure the resistance between body ground and each of +SL and -SL.

OK:

Resistance: 1 MΩ or Higher

NG

Go to step 9.

OK

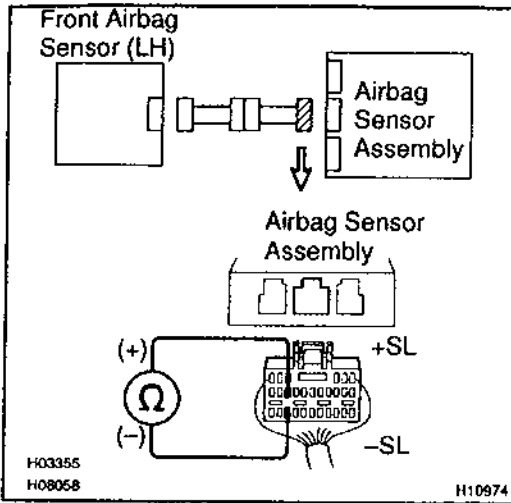
4 Check wire harness.**CHECK:**

For the connector (on the airbag sensor assembly side) between the front airbag sensor (LH) and the airbag sensor assembly, measure the resistance between +SL and -SL.

OK:

Resistance: 1 MΩ or Higher

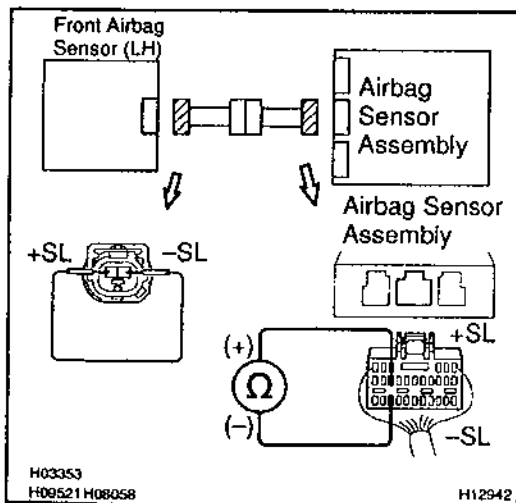
NG**Go to step 10.****OK****5 Check wire harness.****PREPARATION:**

Using a service wire, connect +SL and -SL of the connector (on the front airbag sensor (LH) side) between the airbag sensor assembly and the front airbag sensor (LH).

CHECK:

For the connector (on the airbag sensor assembly side) between the front airbag sensor (LH) and the airbag sensor assembly, measure the resistance between +SL and -SL.

OK:

Resistance: Below 1 Ω

NG**Go to step 11.****OK**

6

Check front airbag sensor (LH).

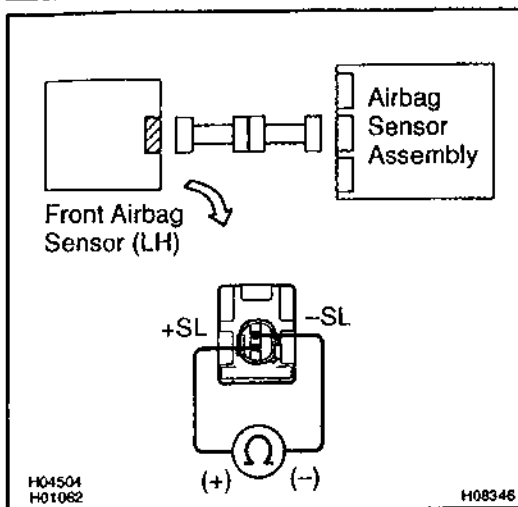
**CHECK:**

For the connector (on the front airbag sensor (LH)), measure the resistance between +SL and -SL.

OK:

Resistance: 300 – 1500 Ω

NG**Replace front airbag sensor (LH).****OK**

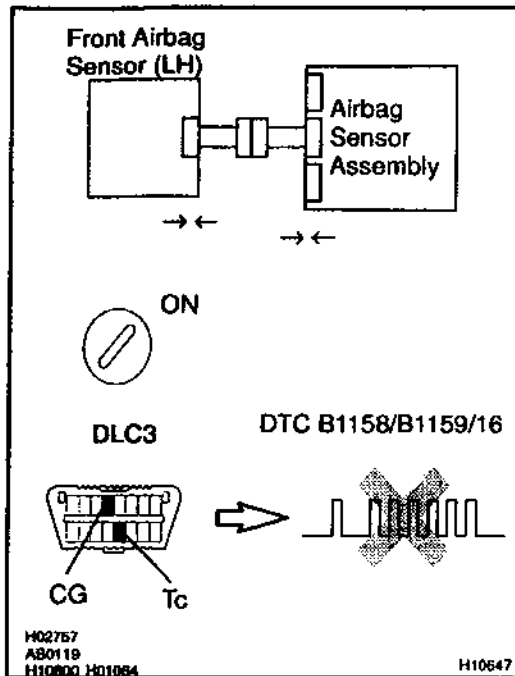
7 Check airbag sensor assembly.**PREPARATION:**

- Turn the ignition switch to LOCK.
- Disconnect negative (-) terminal cable from the battery, and wait at least for 90 seconds.
- Connect the front airbag sensor (LH) connector and airbag sensor assembly connector.
- Connect negative (-) terminal cable to the battery, and wait at least for 2 seconds.

CHECK:

- Turn the ignition switch to ON, and wait at least for 20 seconds.
- Clear the DTC stored in memory (See page DI-326).
- Turn the ignition switch to LOCK, and wait at least for 20 seconds.
- Turn the ignition switch to ON, and wait at least for 20 seconds.
- Check the DTC (See page DI-326).

OK:

DTC B1158/B1159/16 is not output.

HINT:

Codes other than code B1158/B1159/16 may be output at this time, but they are not relevant to this check.

NG

Replace airbag sensor assembly.

OK

From the results of the above inspection, the malfunctioning part can now be considered normal. To make sure of this, use the simulation method to check.

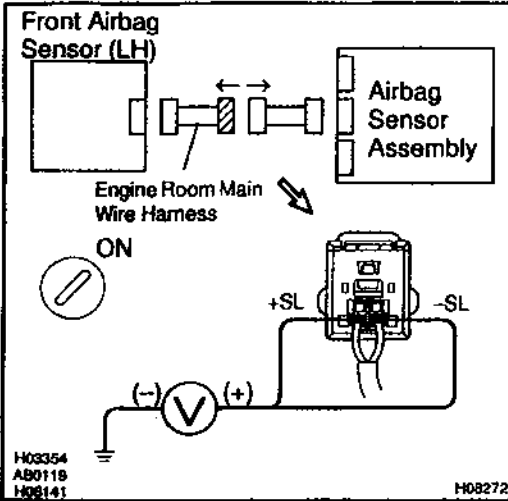
8 Check engine room main wire harness (to B+).**PREPARATION:**

Disconnect the engine room main wire harness connector on the airbag sensor assembly side.

CHECK:

- (a) Turn the ignition switch to ON.
- (b) For the connector (on the LH front door wire harness side) between the airbag sensor assembly and the engine room main wire harness, measure the voltage between body ground and each of +SL and -SL.

OK:

Voltage: Below 1 V

NG

Repair or replace engine room main wire harness.

OK

Repair or replace harness or connector between airbag sensor assembly and engine room main wire harness.

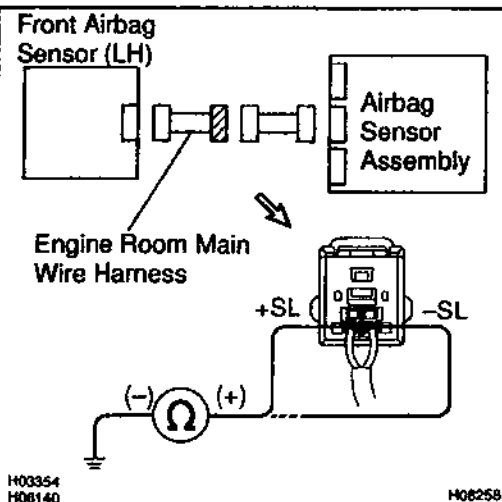
9 Check engine room main wire harness (to ground).**PREPARATION:**

Disconnect the engine room main wire harness connector on the airbag sensor assembly side.

CHECK:

For the connector (on the engine room main wire harness side) between the airbag sensor assembly and the engine room main wire harness, measure the resistance between body ground and each of +SL and -SL.

OK:

Resistance: 1 MΩ or Higher

NG

Repair or replace engine room main wire harness.

OK

Repair or replace harness or connector between airbag sensor assembly and engine room main wire harness.

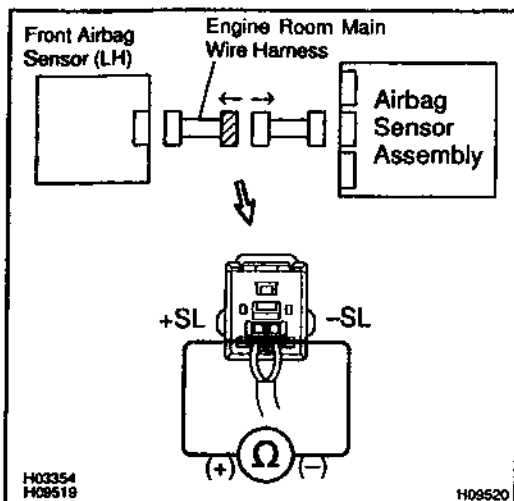
10 Check engine room main wire harness.**PREPARATION:**

Disconnect the engine room main wire harness connector on the airbag sensor assembly side.

CHECK:

For the connector (on the engine room main wire harness side) between the airbag sensor assembly and the engine room main wire harness, measure the resistance between +SL and -SL.

OK:

Resistance: 1 MΩ or Higher

NG

Repair or replace engine room main wire harness.

OK

Repair or replace harness or connector between airbag sensor assembly and engine room main wire harness.

11 Check engine room main wire harness.

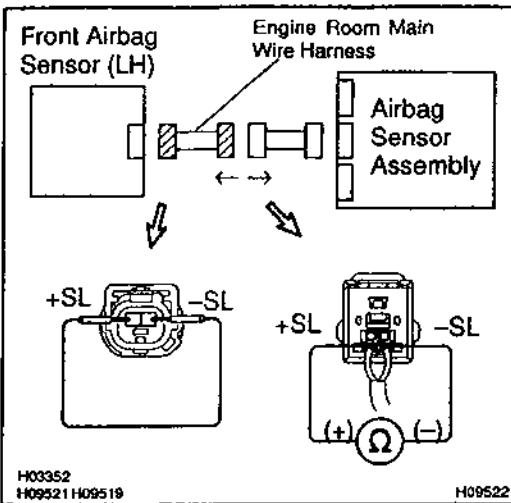

PREPARATION:

- Disconnect the engine room main wire harness connector on the airbag sensor assembly side.
- Using a service wire, connect +SL and -SL of the connector (on the engine room main wire harness side) between the engine room main wire harness and the front airbag sensor (LH).

CHECK:

For the connector (on the engine room main wire harness side) between the airbag sensor assembly and the engine room main wire harness, measure the resistance between +SL and -SL.

OK:

Resistance: Below 1 Ω

NG

Repair or replace engine room main wire harness.

OK

Repair or replace harness or connector between airbag sensor assembly and engine room main wire harness.

DTC	Normal	Source Voltage Drop
------------	---------------	----------------------------

CIRCUIT DESCRIPTION

The SRS is equipped with a voltage-increase circuit (DC-DC converter) in the airbag sensor assembly in case the source voltage drops.

When the battery voltage drops, the voltage-increase circuit (DC-DC converter) functions to increase the voltage of the SRS to normal voltage.

The diagnosis system malfunction display for this circuit is different from other circuits that is when the SRS warning light remains lit up and the DTC is a normal code, source voltage drop is indicated.

Malfunction in this circuit is not recorded in the airbag sensor assembly, and the source voltage returns to normal, the SRS warning light automatically goes off.

DTC No.	Diagnosis
(Normal)	Source voltage drop

WIRING DIAGRAM

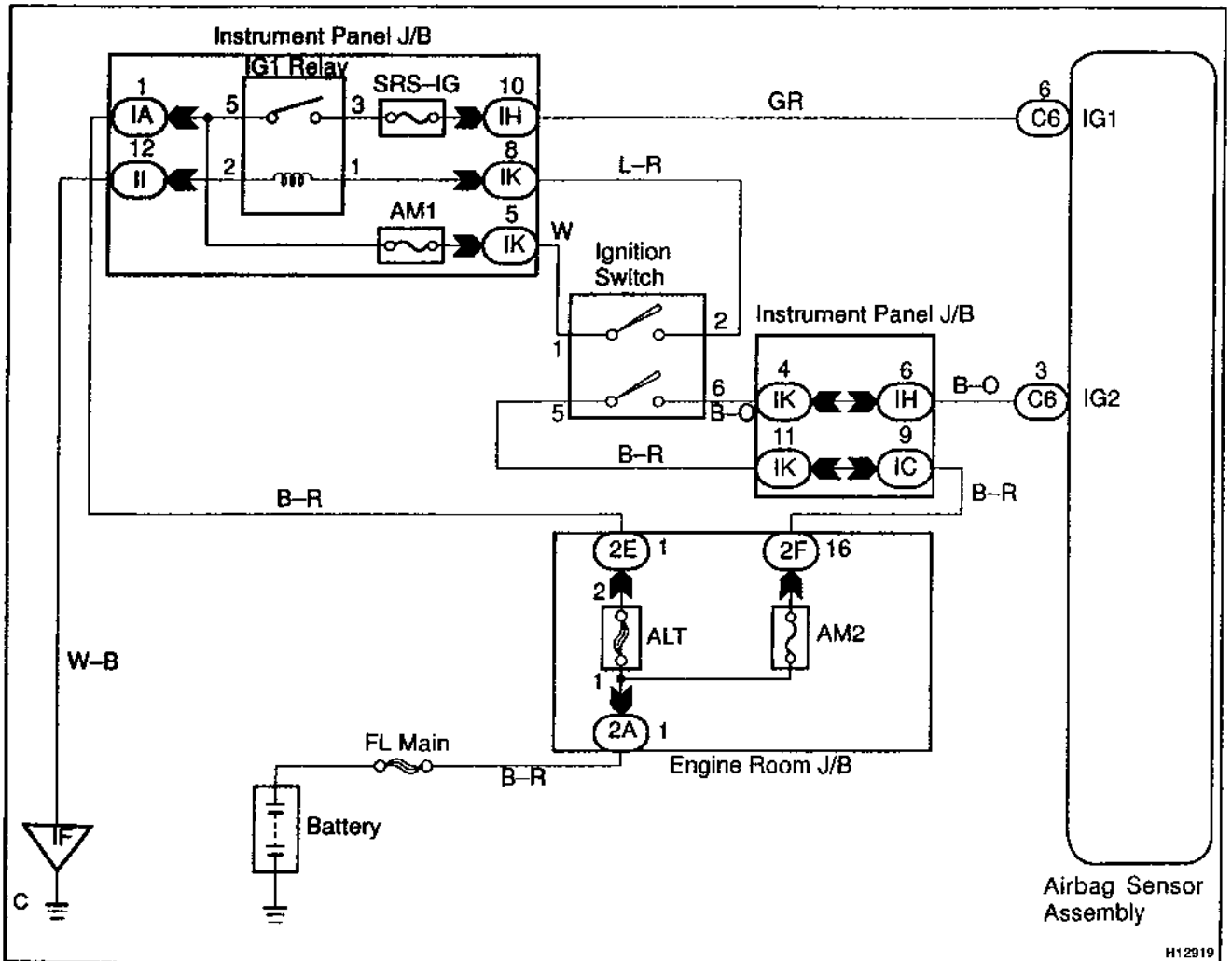

INSPECTION PROCEDURE

1 Prepare for inspection.

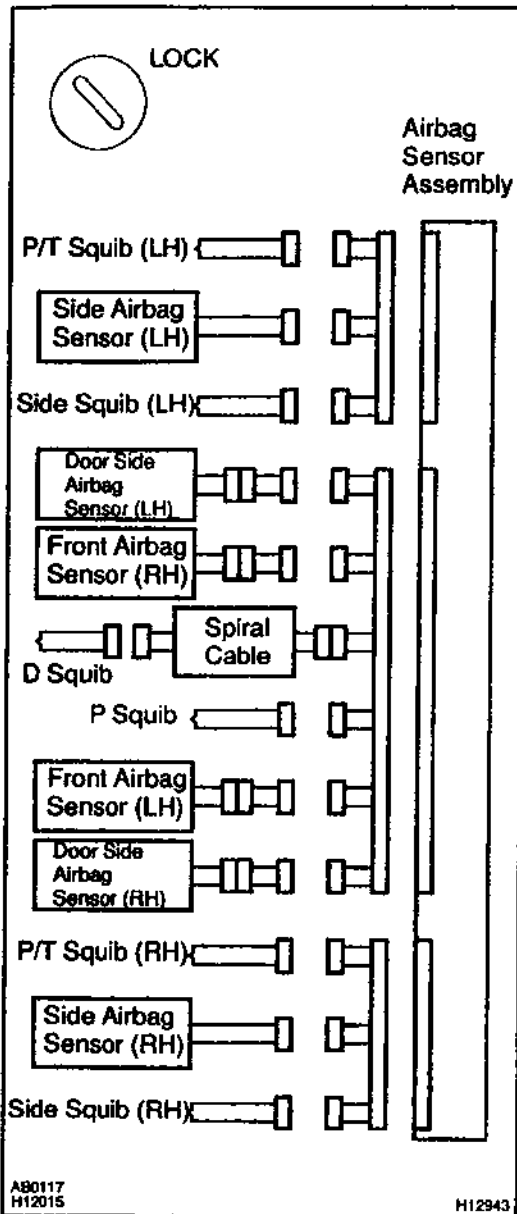
**PREPARATION:**

- Disconnect negative (-) terminal cable from the battery, and wait at least for 90 seconds.
- Remove the steering wheel pad (See page SR-11).
- Disconnect the connector of the front passenger airbag assembly (See page RS-27).
- Disconnect the connector of the side airbag assembly RH and LH (See page RS-40).
- Disconnect the connector of the seat belt pretensioner RH and LH (See page BO-109).
- Disconnect the connectors of the airbag sensor assembly (See page RS-53).
- Disconnect the connector of the front airbag sensor RH and LH (See page RS-58).
- Disconnect the connector of the side airbag sensor assembly RH and LH (See page RS-63).
- Disconnect the connector of the door side airbag sensor RH and LH (See page RS-68).

CAUTION:

Store the steering wheel pad, front passenger airbag assembly and side airbag assembly with the front surface facing upward.

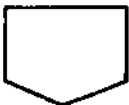

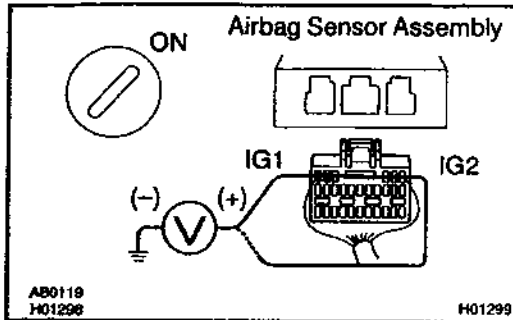
2 Check source voltage.**PREPARATION:**

Connect negative (-) terminal cable to the battery.

CHECK:

- (a) Turn ignition switch ON.
- (b) Measure the voltage between body ground and each of IG1 and IG2 on the sensor and operate electric system (defogger, wiper, headlight, heater blower, etc.).

OK:

Voltage: 10 - 14 V

NG

Check harness between battery and airbag sensor assembly, and check battery and charging system.

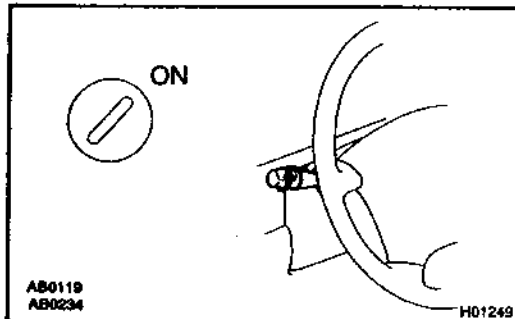
OK**3 Does SRS warning light turn off?****PREPARATION:**

- (a) Turn the ignition switch to LOCK.
- (b) Connect the steering wheel pad connector.
- (c) Connect the front passenger airbag assembly connector.
- (d) Connect the side airbag assembly connectors.
- (e) Connect the seat belt pretensioner connectors.
- (f) Connect the airbag sensor assembly connectors.
- (g) Connect the front airbag sensor connectors.
- (h) Connect the side airbag sensor assembly connectors.
- (i) Connect the door side airbag sensor connectors.
- (j) Turn the ignition switch to ON.

CHECK:

Operate electric system (defogger, wiper, headlight, heater blower, etc.) and check that SRS warning light goes off.

NO

Check for DTCs. If a DTC is output, perform troubleshooting for the DTC. If a normal code is output, replace airbag sensor assembly.

YES

From the results of the above inspection, the malfunctioning part can now be considered normal. To make sure of this, use the simulation method to check.

SRS Warning Light Circuit Malfunction

CIRCUIT DESCRIPTION

The SRS warning light is located on the combination meter.

When the SRS is normal, the SRS warning light lights up for approx. 6 seconds after the ignition switch is turned from the LOCK position to ON position, and then turns off automatically.

If there is a malfunction in the SRS, the SRS warning light lights up to inform the driver of the abnormality. When terminals Tc and CG of the DLC3 are connected, the DTC is displayed by blinking the SRS warning light.

WIRING DIAGRAM

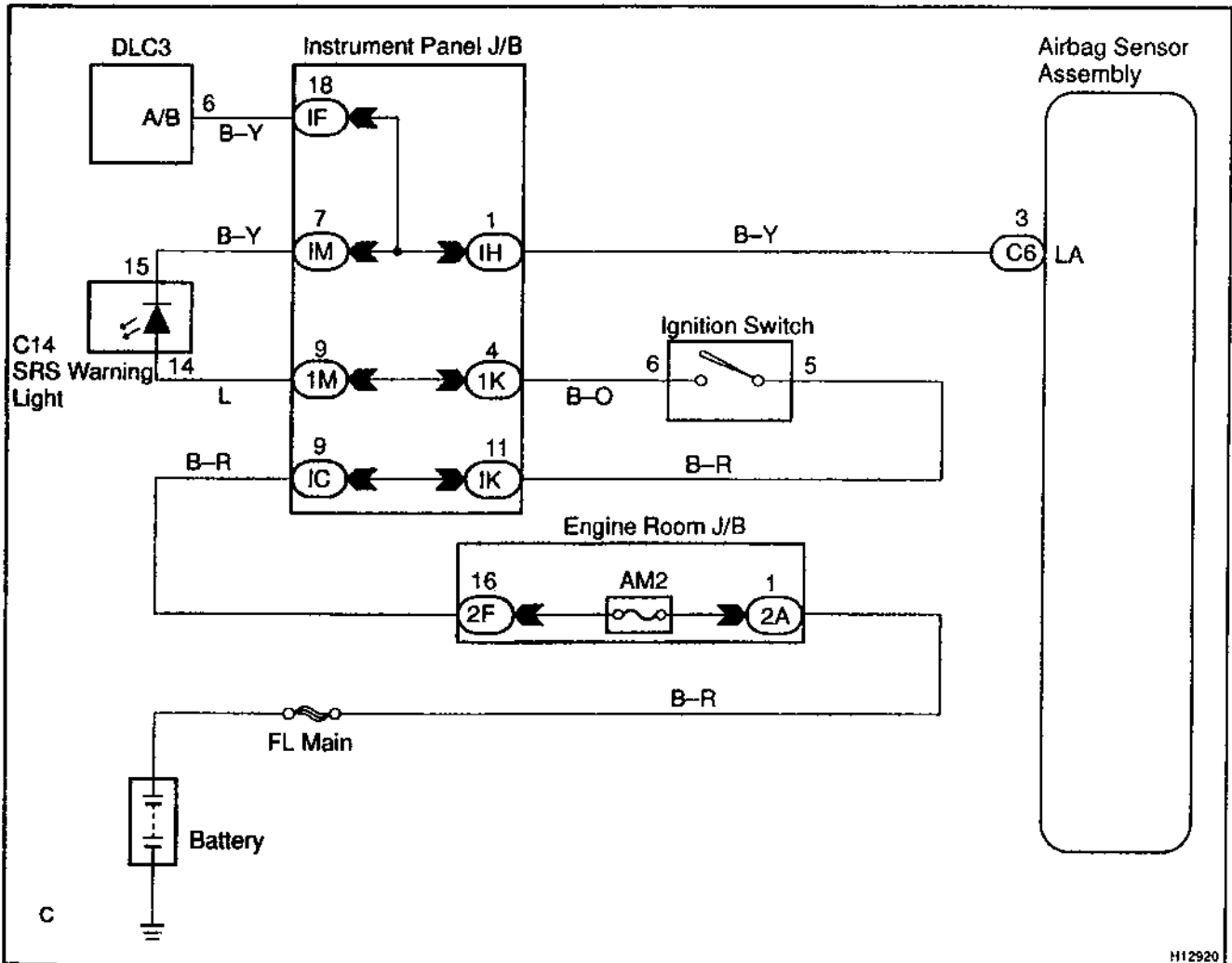

INSPECTION PROCEDURE

Always lights up, when ignition switch is in LOCK position

1 Prepare for inspection (See step 1 on page DI-471).

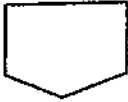

2 Does SRS warning light turn off?

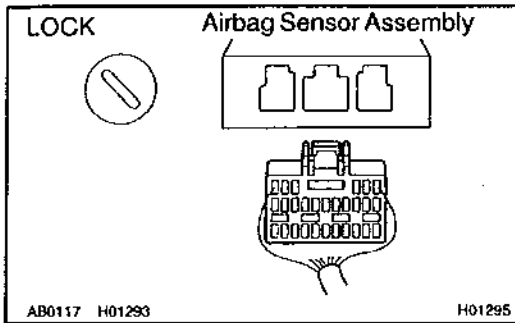

PREPARATION:

- (a) Turn the ignition switch to LOCK.
- (b) Disconnect negative (-) terminal cable from the battery, and wait at least for 90 seconds.
- (c) Disconnect the airbag sensor assembly connector.
- (d) Connect negative (-) terminal cable to the battery.

CHECK:

Check operation of SRS warning light.

NO Check SRS warning light circuit or terminal A/B circuit of DLC3.

YES

Replace airbag sensor assembly.

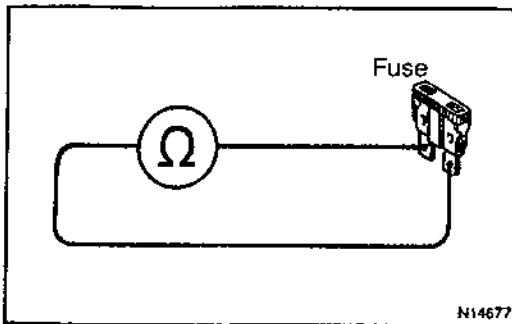
Does not light up, when ignition switch is turned to ON**1 Check AM2 Fuse.****PREPARATION:**

Remove the AM2 fuse.

CHECK:

Check continuity of the AM2 fuse.

OK:**Continuity****HINT:**

- Fuse may be burnt out even if it appears to be OK during visual inspection.
- If fuse is OK, install it.

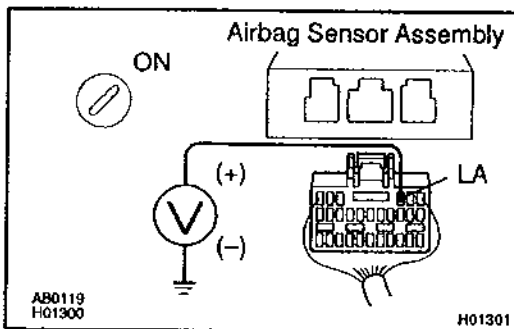
NG**Go to step 5.****OK****2 Prepare for inspection (See step 1 on page DI-471).****3 Check SRS warning light circuit.****PREPARATION:**

(a) Connect negative (-) terminal cable to the battery.

(b) Turn the ignition switch to ON.

CHECK:

Measure the voltage between body ground and LA terminal of the harness side connector of the airbag sensor assembly.

OK:**Voltage: 10 - 14 V****NG****Check combination meter or repair SRS warning light circuit.****OK**

4 Does SRS warning light come on?

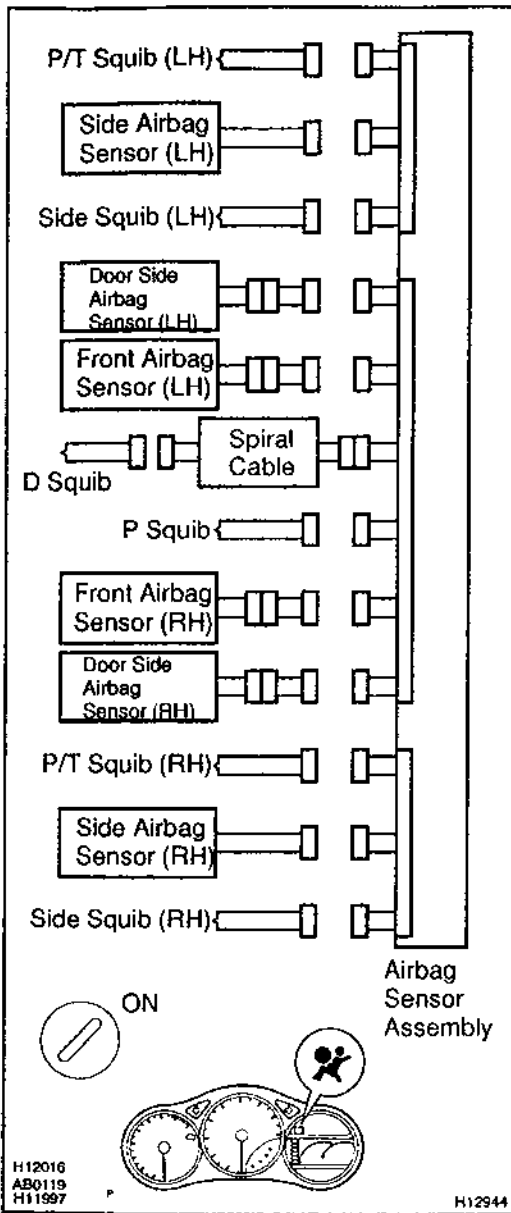

PREPARATION:

- Disconnect negative (-) terminal cable from the battery.
- Connect the airbag sensor assembly connector.
- Connect negative (-) terminal cable to the battery, and wait at least for 2 seconds.
- Turn the ignition switch to ON.

CHECK:

Check operation of the SRS warning light.

NO

Check terminal LA of airbag sensor assembly. If normal, replace airbag sensor assembly.

YES

From the results of the above inspection, the malfunctioning part can now be considered normal. To make sure of this, use simulation method to check.

5	Is new AM2 fuse burnt out again?
---	----------------------------------

NO

Using simulation method, reproduce malfunction symptoms (See page IN-20).

YES

Check harness between AM2 fuse and SRS warning light.

Tc Terminal Circuit

CIRCUIT DESCRIPTION

By connecting terminals Tc and CG of the DLC3 the airbag sensor assembly is set in the DTC output mode. The DTCs are displayed by blinking the SRS warning light.

WIRING DIAGRAM

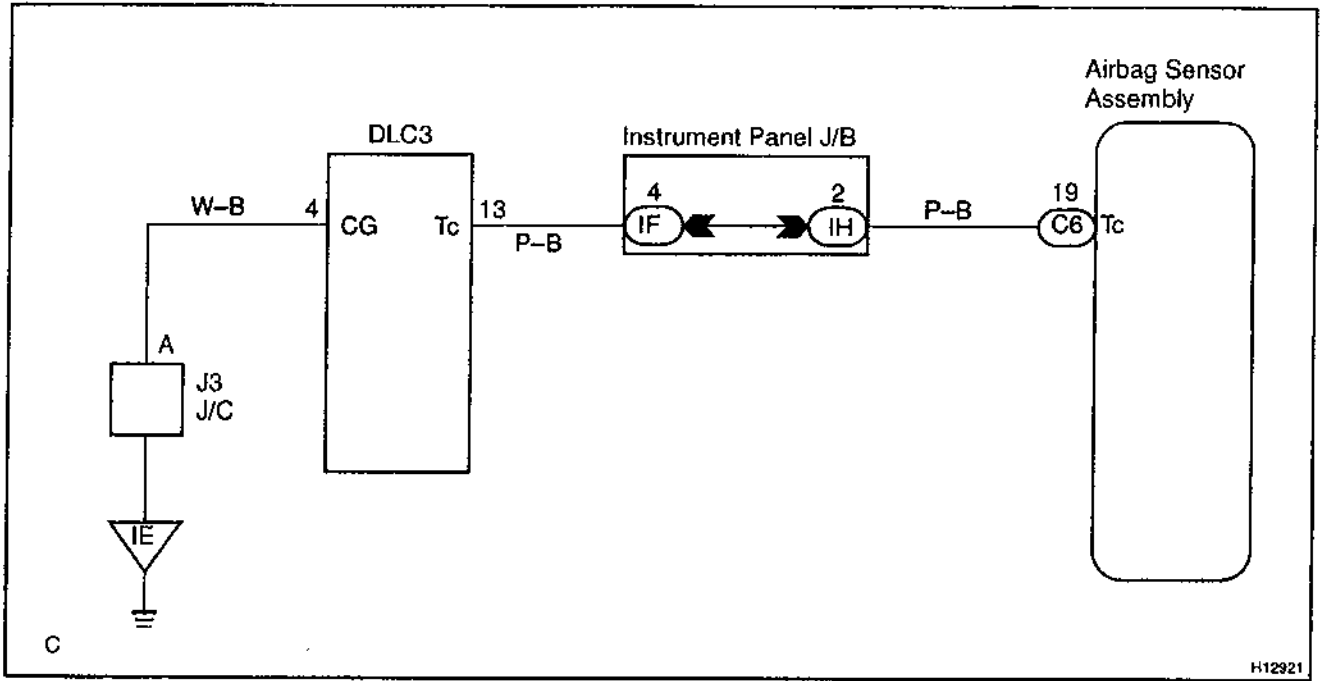

INSPECTION PROCEDURE

If the DTC is not displayed, do the following troubleshooting.

1 Does SRS warning light light up for approx. 6 seconds?

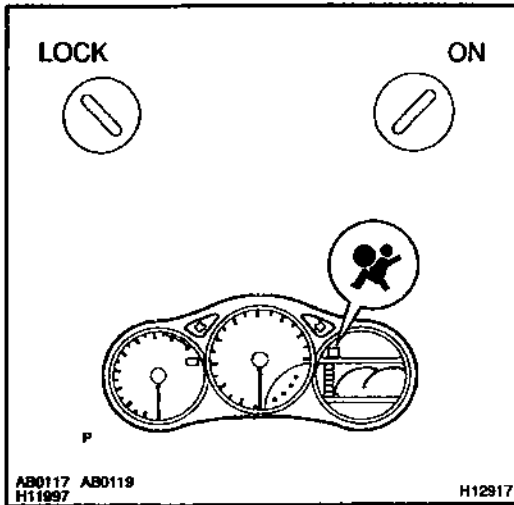

PREPARATION:

Check operation of the SRS warning light after ignition switch is turned from LOCK position to ON position.

NO Check SRS warning light system (See page DI-474).

YES

2 Check voltage between terminals Tc and CG of DLC3.

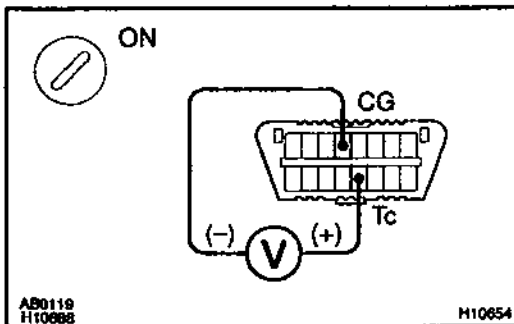

PREPARATION:

Turn the ignition switch to ON.

CHECK:

Measure the voltage between terminals Tc and CG of DLC3.

OK:

Voltage: 10 - 14 V

OK Go to step 4.

NG

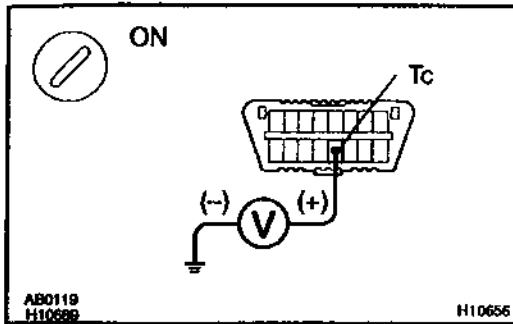
3 Check voltage between terminal Tc of DLC3 and body ground.**CHECK:**

Measure the voltage between terminal Tc of DLC3 and body ground.

OK:

Voltage: 10 - 14 V

OK

Check harness between terminal E1 of DLC3 and body ground.

NG

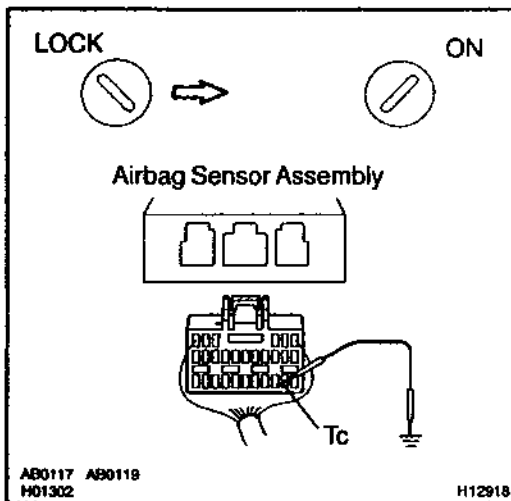
4 Check airbag sensor assembly.**PREPARATION:**

- Turn the ignition switch to LOCK.
- Disconnect negative (-) terminal cable from the battery, and wait at least for 90 seconds.
- Disconnect the airbag sensor assembly connector.
- Insert service wire into terminal Tc from back side as shown in the illustration.
- Connect the airbag sensor assembly connector with service wire.
- Connect negative (-) terminal cable to the battery.
- Turn the ignition switch to ON and wait at least for 20 seconds.
- Connect service wire of terminal Tc to body ground.

CHECK:

Check operation of the SRS warning light.

OK:

SRS warning light comes on.

NOTICE:

Pay due attention to the terminal connecting position to avoid a malfunction.

OK

Check harness between the airbag sensor assembly and DLC3.

NG

Replace airbag sensor assembly.

If the DTC is displayed without a DTC check procedure, perform the following troubleshooting.

- | | |
|----------|----------------------------------------------------------------------------------------|
| 1 | Check resistance between terminal Tc of airbag sensor assembly and body ground. |
|----------|----------------------------------------------------------------------------------------|

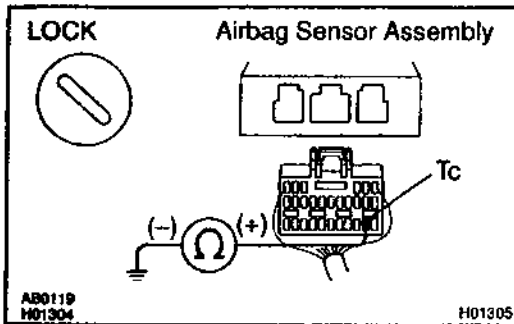
**PREPARATION:**

- (a) Turn the ignition switch to LOCK.
- (b) Disconnect negative (-) terminal cable from the battery, and wait at least for 90 seconds.
- (c) Disconnect the airbag sensor assembly connector.

CHECK:

Check resistance between terminal Tc of the airbag sensor assembly connector and body ground.

OK:

Resistance: 1 MΩ or Higher

NG

Repair or replace harness or connector.

OK

Replace airbag sensor assembly.

CRUISE CONTROL SYSTEM

HOW TO PROCEED WITH TROUBLESHOOTING

068F-14

Troubleshoot in accordance with the procedure on the following page.

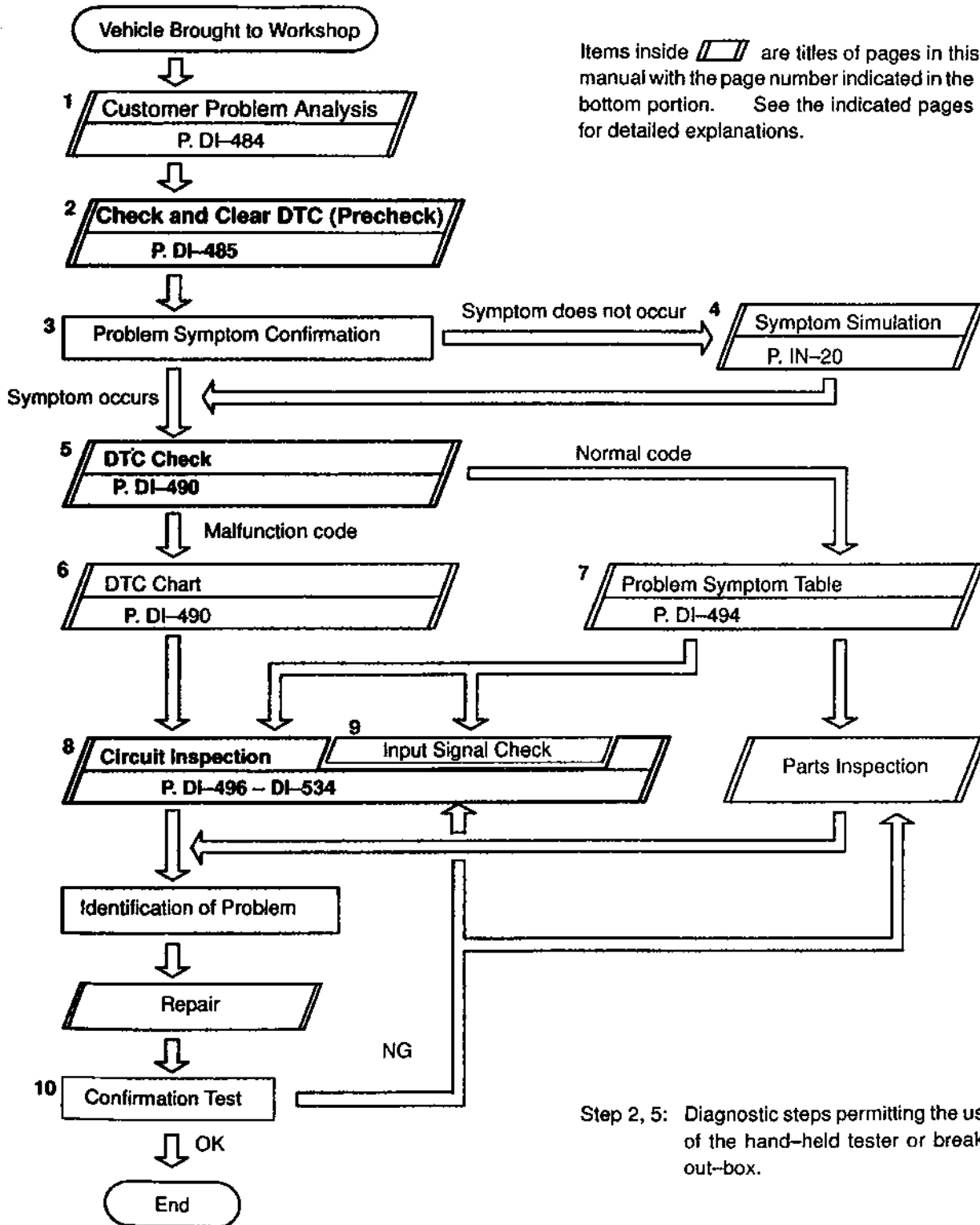

Step 2, 5: Diagnostic steps permitting the use of the hand-held tester or break-out-box.

CUSTOMER PROBLEM ANALYSIS CHECK

CRUISE CONTROL SYSTEM Check Sheet

Inspector's name: _____

Customer's Name		Registration No.	
		Registration Year	
		Frame No.	
Date Vehicle Brought In	/ /	Odometer Reading	km Mile

Condition of Problem Occurrence	Date of Problem Occurrence	/ /
	How Often does Problem Occurs	<input type="checkbox"/> Continuous <input type="checkbox"/> Intermittent (Times a day)
	Vehicle Speed when Problem Occurred	km Mile

Symptoms	<input type="checkbox"/> Auto cancel occurs	<ul style="list-style-type: none"> • Driving condition <ul style="list-style-type: none"> <input type="checkbox"/> City driving <input type="checkbox"/> Freeway <input type="checkbox"/> Up hill <input type="checkbox"/> Down hill • After cancel occurred, did the driver activate cruise control again? <ul style="list-style-type: none"> <input type="checkbox"/> Yes <input type="checkbox"/> No
	<input type="checkbox"/> Cancel does not occur	<input type="checkbox"/> With brake ON <input type="checkbox"/> Except D position shift <input type="checkbox"/> At 40 km/h (25 mph) or less <input type="checkbox"/> When control SW turns to CANCEL position
	<input type="checkbox"/> Cruise control malfunction	<input type="checkbox"/> Slip to acceleration side <input type="checkbox"/> Slip to deceleration side <input type="checkbox"/> Hunting occurs <input type="checkbox"/> O/D cut off does not occur <input type="checkbox"/> O/D does not return
	<input type="checkbox"/> Switch malfunction	<input type="checkbox"/> SET <input type="checkbox"/> ACCEL <input type="checkbox"/> COAST <input type="checkbox"/> RESUME <input type="checkbox"/> CANCEL
	<input type="checkbox"/> Cruise MAIN indicator light	<input type="checkbox"/> Remains ON <input type="checkbox"/> Does not light up <input type="checkbox"/> Blinking

DTC Check	1st Time	<input type="checkbox"/> Normal Code <input type="checkbox"/> Malfunction Code (Code)
	2nd Time	<input type="checkbox"/> Normal Code <input type="checkbox"/> Malfunction Code (Code)

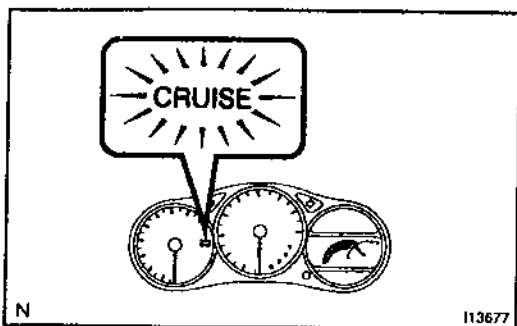

PRE-CHECK

1. DIAGNOSIS SYSTEM

- (a) Check the indicator.
 - (1) Turn the ignition switch ON.
 - (2) Check that the CRUISE MAIN indicator light comes ON when the cruise control main switch is turned ON, and that the indicator light goes OFF when the main switch is turned OFF.

HINT:

If the indicator check result is not normal, proceed to troubleshooting (See page BE-42) for the combination meter section.

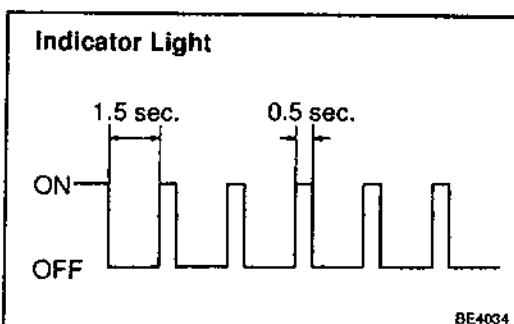

- (b) Check the DTC.

HINT:

If a malfunction occurs in the No. 1 vehicle speed sensor or actuator, etc. during cruise control driving, the ECU actuates AUTO CANCEL of the cruise control and turns on and off the CRUISE MAIN indicator light to inform the driver of a malfunction. At the same time, the malfunction is stored in memory as a DTC.

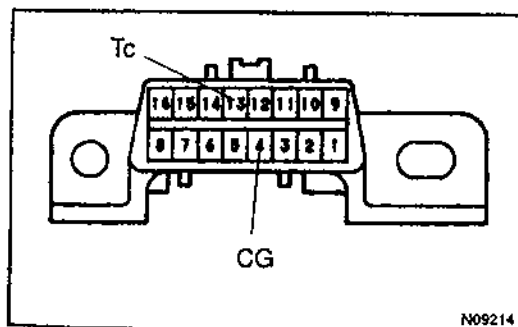

- (c) Output of DTC using diagnosis check wire.

- (1) Turn the ignition switch ON.
- (2) Using SST, connect terminals Tc and CG of DLC3.
SST 09843-18020
- (3) Read the DTC on the CRUISE MAIN indicator light.

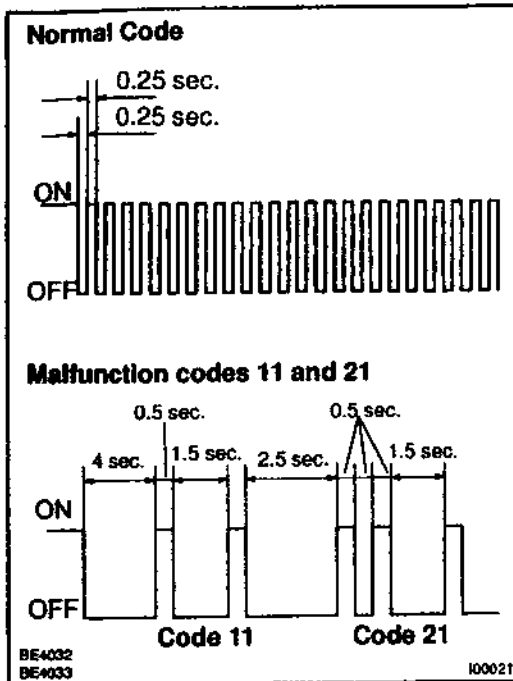
**HINT:**

If the DTC is not output, inspect the diagnosis circuit (See page DI-532).

As an example, the blinking patterns for codes; normal, 11 and 21 are shown in the illustration.

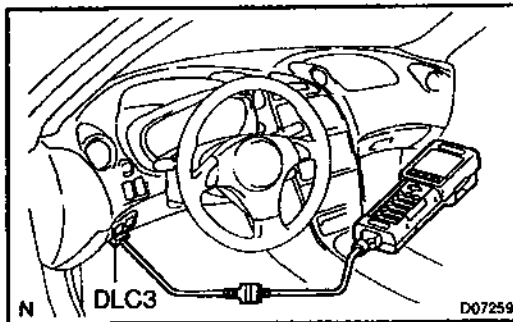
**2. USING HAND-HELD TESTER**

- (a) Hook up the hand-held tester to the DLC3.
- (b) Monitor the ECU data by following the prompts on the tester screen.

HINT:

Hand-held tester has a "Snapshot" function which records the monitored data.

Please refer to the hand-held tester operator's manual for further details.

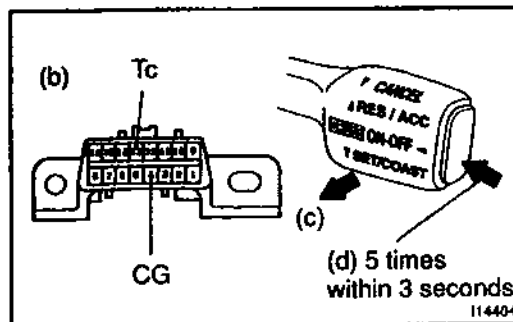
**3. DTC CLEARANCE (ERASE MODE)****HINT:**

During in the erase mode, diag detection does not work.

- (a) Drive at about 15 km/h or below.
- (b) Using SST, connect terminals Tc and E1 of DLC3.
SST 09843-18020
- (c) Pull the cruise control switch to CANCEL.
- (d) On the above mentioned condition, turn on the cruise control main switch 5 times within 3 seconds.

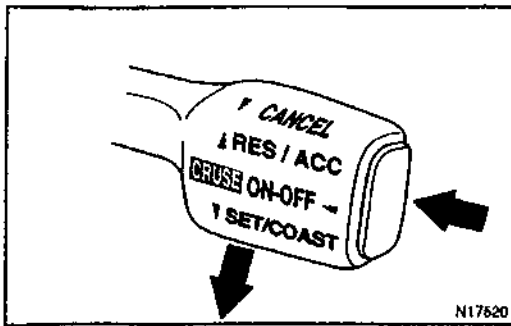

4. PROBLEM SYMPTOM CHECK (ROAD TEST)

- (a) Inspect the SET switch.
- (1) Push the main switch ON.
 - (2) Drive at a desired speed (40 km/h (25 mph) or higher).
 - (3) Press the control switch to the SET/COAST.
 - (4) After releasing the switch, check that the vehicle cruises at the desired speed.

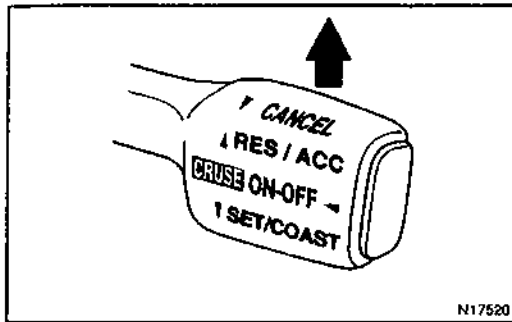

- (b) Inspect the ACCEL switch.
- (1) Push the main switch ON.
 - (2) Drive at a desired speed (40 km/h (25 mph) or higher).
 - (3) Check that the vehicle speed increases while the control switch is turned to RES/ACC, and that the vehicle cruises at the set speed when the switch is released.
 - (4) Momentarily raise the control switch upward to the RES/ACC position and then immediately release it. Check that the vehicle speed increases by approx. 1.5 km/h (Tap-up function).

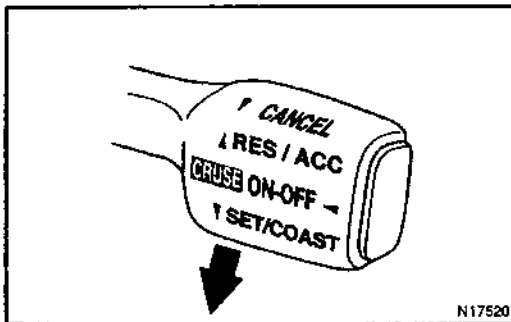

- (c) Inspect the COAST switch.
- (1) Push the main switch ON.
 - (2) Drive at a desired speed (40 km/h (25 mph) or higher).
 - (3) Check that the vehicle speed decreases while the control switch is turned to SET/COAST, and the vehicle cruises at the set speed when the switch is released.
 - (4) Momentarily pull the control switch down to SET/COAST, and then immediately release it. Check that the vehicle speed decreases by about 1.5 km/h (Tap-down function).

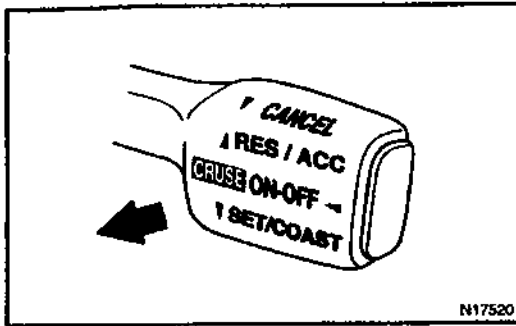

- (d) Inspect the CANCEL switch.
- (1) Push the main switch ON.
 - (2) Drive at a desired speed (40 km/h (25 mph) or higher).
 - (3) When operating one of the following operations, check that the cruise control system is cancelled and that the normal driving mode is reset.
 - Depress the brake pedal
 - Depress the clutch pedal (M/T)
 - Shift to except D position (A/T)
 - Push the main switch OFF
 - Pull the cruise control switch to CANCEL

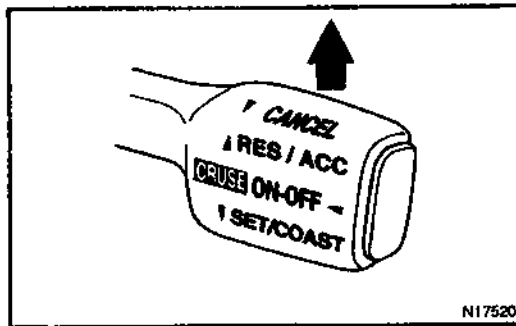

- (e) Inspect the RESUME switch.
- (1) Push the main switch ON.
 - (2) Drive at a desired speed (40 km/h (25 mph) or higher).
 - (3) When operating one of the following operations check that the cruise control system is cancelled and that the normal driving mode is reset.
 - Depress the brake pedal
 - Depress the clutch pedal (M/T)
 - Shift to except D position (A/T)
 - Push the main switch OFF
 - Pull the cruise control switch to CANCEL
 - (4) After the control switch is turned to RES/ACC at the driving speed of more than 40 km/h (25 mph), check that the vehicle restores the speed prior to the cancellation.

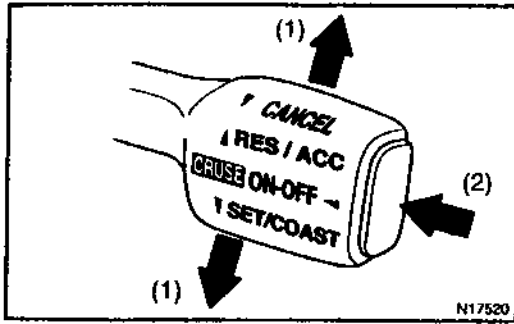

5. INPUT SIGNAL CHECK

HINT:

(1) For check No.1 ~ No.3:

Turn ignition switch ON.

(2) For check No.4:

- Jack up the vehicle.
 - Start the engine.
 - Shift to D position.
- (a) Pull the control switch to SET/COAST or RES/ACC position and hold it down or up (1).
 - (b) Push the main switch ON (2).
 - (c) Check that the CRUISE MAIN indicator light blinks twice or 3 times repeatedly after 3 seconds.
 - (d) Turn the SET/COAST or RES/ACC switch OFF.
 - (e) Operate each switch as listed in the table below.
 - (f) Read the blinking pattern of the CRUISE MAIN indicator light.
 - (g) After performing the check, turn the main switch OFF.

HINT:

When 2 or more signals are input to the ECU, the lowest numbered code will be displayed 1st.

No.	Operation Method	CRUISE MAIN Indicator Light Blinking Pattern	Diagnosis
1	Turn SET/COAST switch ON		SET/COAST switch circuit is normal
2	Turn RES/ACC switch ON		RES/ACC switch circuit is normal
3	Turn CANCEL switch ON		CANCEL switch circuit is normal
	Turn stop light switch ON Depress brake pedal		Stop light switch circuit is normal
	Turn PNP switch OFF (Shift to except D position)		PNP switch circuit is normal
	Turn clutch switch OFF (Depress clutch pedal)		Clutch switch circuit is normal
4	Drive at about 40 km/h (25 mph) or higher		Vehicle Speed Sensor is normal
	Drive at about 40 km/h (25 mph) or below		

DIAGNOSTIC TROUBLE CODE CHART

If a malfunction code is displayed during the DTC check, check the circuit listed for that code in the table below and proceed to the appropriate page.

DTC No. (See Page)	Circuit Inspection	Trouble Area
11, 15 (DI-496)	Actuator Motor Circuit	<ul style="list-style-type: none"> • Actuator motor • Harness or connector between cruise control ECU and actuator motor • Cruise control ECU
12, 43 (DI-498)	Actuator Magnetic Clutch Circuit	<ul style="list-style-type: none"> • STOP Fuse • Stop light switch • Actuator magnetic clutch • Harness or connector between cruise control ECU and actuator magnetic clutch, actuator magnetic clutch and body ground • Cruise control ECU
14 (DI-502)	Actuator Mechanical Malfunction	<ul style="list-style-type: none"> • Actuator motor (actuator lock: motor, arm) • Cruise control ECU
21 (DI-504)	Open in Vehicle Speed Sensor Circuit	<ul style="list-style-type: none"> • Combination meter • Harness or connector between cruise control ECU and combination meter, combination meter and vehicle speed sensor • Vehicle speed sensor • Cruise control ECU
23 (DI-508)	Vehicle Speed Signal Abnormal	<ul style="list-style-type: none"> • Vehicle speed sensor • Cruise control ECU
41	Cruise control ECU	<ul style="list-style-type: none"> • Cruise control ECU
42	Source voltage drop	<ul style="list-style-type: none"> • Power source

PARTS LOCATION

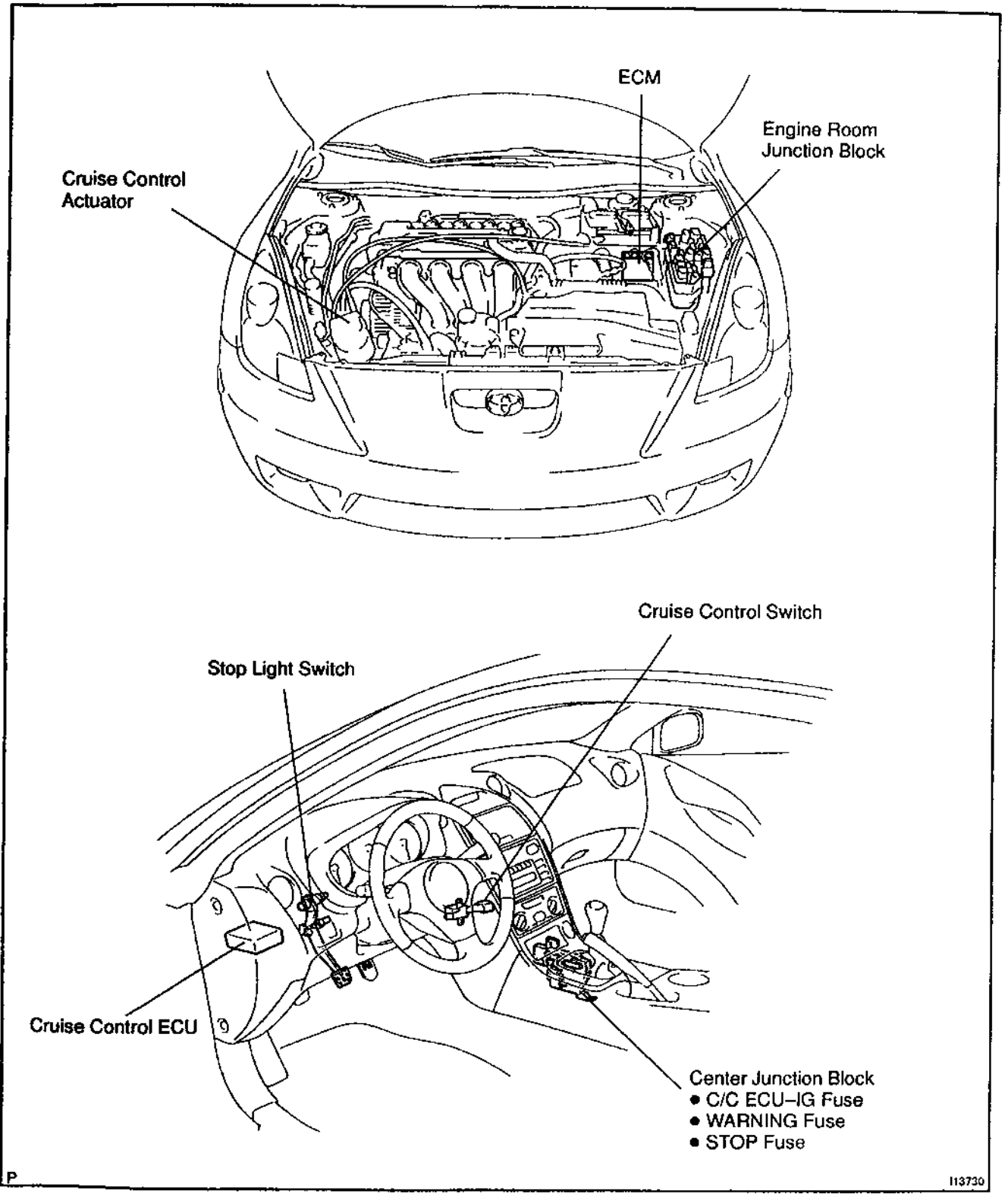

TERMINALS OF ECU

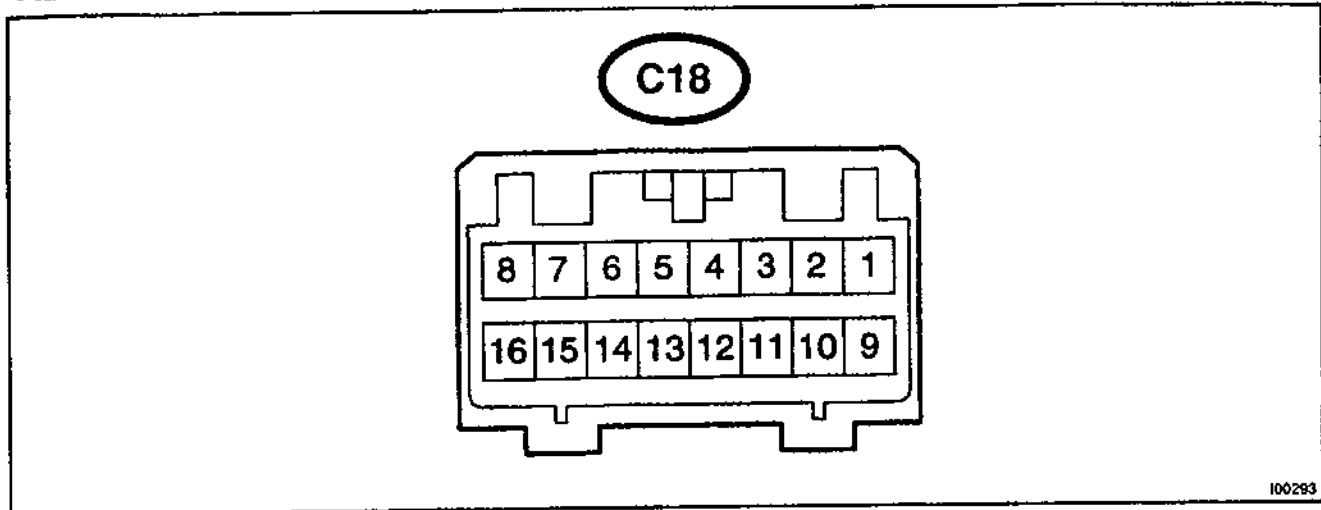

100283

Symbols (Terminals No.)	Wiring Color	Condition	STD Voltage (V)
STP ↔ GND (C18-2 ↔ C18-16)	G-W ↔ W-B	Depress brake pedal	10 - 16 V
		Release brake pedal	Below 1 V
D ↔ GND (C18-3 ↔ C18-16)	B-Y ↔ W-B	Shift to positions except D	Below 1 V
		Shift to D position	10 - 16 V
PI ↔ GND (C18-4 ↔ C18-16)	Y-B ↔ W-B	Ignition switch ON Cruise control main switch ON	Below 1.2 V
		Ignition switch ON Cruise control main switch OFF	10 - 16 V
TC ↔ GND (C18-5 ↔ C18-16)	P-B ↔ W-B	Ignition switch ON	10 - 16 V
		Ignition switch ON Connect terminals Tc and E1 of diagnostic check connector	Below 1 V
ECT ↔ GND (C18-6 ↔ C18-16)	Y ↔ W-B	During driving Gear position 3rd	10 - 16 V
		During driving Gear position O/D	Below 1 V
MC ↔ GND (C18-7 ↔ C18-16)	R-W ↔ W-B	During cruise control driving COAST switch held ON	9 - 15 V
		During cruise control driving ACC switch held ON	Below 1 V
L ↔ GND (C18-8 ↔ C18-16)	G-B ↔ W-B	During cruise control driving	9 - 15 V
		Except during cruise control driving	Below 1 V
B ↔ GND (C18-9 ↔ C18-16)	B-O ↔ W-B	Ignition switch ON	10 - 16 V
CCS ↔ GND (C18-10 ↔ C18-16)	W ↔ W-B	Ignition switch ON	10 - 16 V
		Ignition switch ON MAIN switch held ON	4.2 - 8.8 V
		Ignition switch ON SET/COAST switch held ON	2.5 - 6.3 V
		Ignition switch ON RES/ACC switch held ON	0.8 - 3.7 V

DIAGNOSTICS - CRUISE CONTROL SYSTEM

SPD ↔ GND (C18-12 ↔ C18-16)	W-R ↔ W-B	Engine start Car stoppage.	Below 1.5 V or 4.7 - 16 V
		During driving (Pulse generated).	3 - 7 V
IDL ↔ GND (C18-13 ↔ C18-16)	L-W ↔ W-B	Ignition switch ON Throttle valve fully opened.	10 - 16 V
		Ignition switch ON Throttle valve fully closed.	Below 1.5 V
OD ↔ GND (C18-14 ↔ C18-16)	B ↔ W-B	During cruise control driving OD switch ON.	10 - 16 V
		During cruise control driving OD switch OFF (3rd driving)	Below 1 V
MO ↔ GND (C18-15 ↔ C18-16)	R-L ↔ W-B	During cruise control driving ACC switch hold ON	9 - 15 V
		During cruise control driving COAST switch hold ON	Below 1 V
GND ↔ Body Ground (C18-16 ↔ Body Ground)	W-B ↔ Body Ground	Constant	Below 1 V

PROBLEM SYMPTOMS TABLE

Symptom	Suspect Area	See page
SET not occurring or CANCEL occurring. (DTC is Normal)	<ol style="list-style-type: none"> 1. Main Switch Circuit (Cruise control switch) 2. Vehicle Speed Sensor 3. Control Switch Circuit (Cruise control switch) 4. Stop Light Switch Circuit 5. Park/Neutral Position Switch Circuit 6. Clutch Switch 7. Actuator Motor Circuit 8. Cruise Control Cable 9. Cruise Control ECU 	DI-509 DI-504 DI-509 DI-515 DI-522 DI-525 DI-496 DI-534 IN-30
SET not occurring or CANCEL occurring. (DTC does not output)	<ol style="list-style-type: none"> 1. ECU Power Source Circuit 2. Cruise Control ECU 	DI-527 IN-30
Actual vehicle speed deviates above or below the set speed.	<ol style="list-style-type: none"> 1. Cruise Control Cable 2. Vehicle Speed Signal Abnormal 3. Electronically Controlled Transmission Communication Circuit 4. Actuator Motor Circuit 5. Idle Signal Circuit (Main throttle position sensor) 6. Cruise Control ECU 	DI-534 DI-504 DI-519 DI-496 DI-512 IN-30
Gear shifting frequent between 3rd O/D when driving on uphill road. (Hunting)	<ol style="list-style-type: none"> 1. Electronically Controlled Transmission Communication Circuit 2. Cruise Control ECU 	DI-519 IN-30
Cruise control not cancelled, even when brake pedal is depressed.	<ol style="list-style-type: none"> 1. Cruise Control Cable 2. Stop Light Switch Circuit 3. Actuator Motor Circuit 4. Cruise Control ECU 	DI-534 DI-515 DI-496 IN-30
Cruise control not cancelled, even when transmission is shifted to "N" position.	<ol style="list-style-type: none"> 1. Cruise Control Cable 2. Park/Neutral Position Switch Circuit 3. Actuator Motor Circuit 4. Cruise Control ECU 	DI-534 DI-522 DI-496 IN-30
Cruise control not cancelled, even when clutch pedal is depressed.	<ol style="list-style-type: none"> 1. Cruise Control Cable 2. Clutch Switch Circuit 3. Actuator Motor Circuit 4. Cruise Control ECU 	DI-534 DI-525 DI-496 IN-30
Control switch does not operate. (SET/COAST, ACC/RES, CANCEL not possible)	<ol style="list-style-type: none"> 1. Cruise Control Cable 2. Control Switch Circuit 3. Actuator Motor Circuit 4. Cruise Control ECU 	DI-534 DI-525 DI-496 IN-30
SET possible at 40 km/h (25 mph) or less, or CANCEL does not operate at 40 km/h (25 mph) or less.	<ol style="list-style-type: none"> 1. Cruise Control Cable 2. Vehicle Speed Signal Abnormal 3. Actuator Motor Circuit 4. Cruise Control ECU 	DI-534 DI-508 DI-496 IN-30
Poor response is in ACCEL and RESUME modes.	<ol style="list-style-type: none"> 1. Cruise Control Cable 2. Electronically Controlled Transmission Communication Circuit 3. Actuator Motor Circuit 4. Cruise Control ECU 	DI-534 DI-519 DI-496 IN-30
O/D does not resume, even though the road is not uphill.	<ol style="list-style-type: none"> 1. Electronically Controlled Transmission Communication Circuit 2. Cruise Control ECU 	DI-519 IN-30
DTC memory is erased.	<ol style="list-style-type: none"> 1. Cruise Control ECU 	IN-30

DIAGNOSTICS - CRUISE CONTROL SYSTEM

DTC is not output, or is output when should not be.	1. Diagnosis Circuit 2. Cruise Control ECU	DI-532 IN-30
Cruise MAIN indicator light remains ON or fails to light up.	1. Cruise MAIN Indicator Light Switch Circuit	DI-530

CIRCUIT INSPECTION

DTC	11, 15	Actuator Motor Circuit
------------	---------------	-------------------------------

CIRCUIT DESCRIPTION

The actuator motor is operated by signals from the ECU. Acceleration and deceleration signals are transmitted according to changes in the Duty Ratio (See below).

Duty Ratio

The duty ratio is the ratio of the period of continuity in one cycle. For example, if A is the period of continuity in one cycle, and B is the period of non-continuity.

$$\text{Duty Ratio} = \frac{A}{A + B} \times 100 (\%)$$

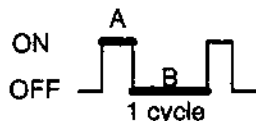

DTC No.	Detection Item	Trouble Area
11	Short in actuator motor circuit.	<ul style="list-style-type: none"> • Actuator motor • Harness or connector between cruise control ECU and actuator motor • Cruise control ECU
15	Open in actuator motor circuit.	<ul style="list-style-type: none"> • Actuator motor

WIRING DIAGRAM

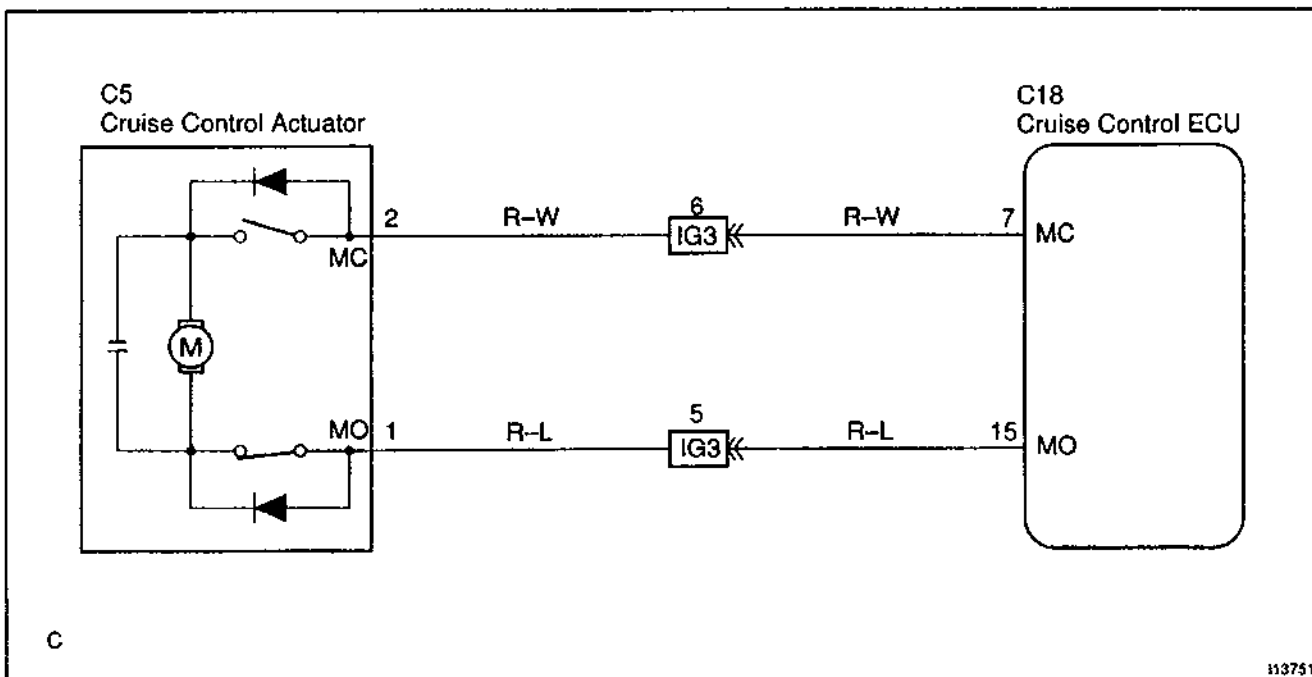

C

INSPECTION PROCEDURE

- 1** Check resistance between terminals MO and MC of actuator motor.

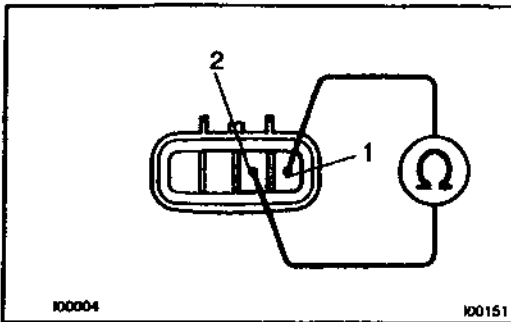
**PREPARATION:**

- (a) Turn ignition switch OFF.
 (b) Disconnect the actuator connector.

CHECK:

Measure resistance between terminals 1 and 2.

HINT:

If control plate is in fully opened or fully closed positions, resistance can not be measured.

OK:

Resistance: more than 4.2 Ω

NG

Replace cruise control actuator.

OK

- 2** Check for open and short in harness and connectors between cruise control ECU and actuator motor (See page IN-30).

NG

Repair or replace harness or connector.

OK

Check and replace cruise control ECU (See page IN-30).

DTC	12, 43	Actuator Magnetic Clutch Circuit
------------	---------------	-----------------------------------------

CIRCUIT DESCRIPTION

This circuit turns on the magnetic clutch inside the actuator during cruise control operation according to the signal from the ECU. If a malfunction occurs in the actuator or speed sensor, etc. during cruise control operation, the rotor shaft between the motor and control plate is released.

When the brake pedal is depressed, the stop light switch turns on, supplying electrical power to the stop light. Power supply to the magnetic clutch is mechanically cut and the magnetic clutch is turned OFF.

When driving downhill, if the vehicle speed exceeds the set speed by 15 km/h (9 mph), the ECU turns the safety magnet clutch OFF. If the vehicle speed later drops to within 10 km/h (6 mph), cruise control at the set speed is resumed.

DTC No.	Detection Item	Trouble Area
12	Short in actuator magnetic clutch circuit. Open (0.8 sec.) in actuator magnetic clutch circuit.	<ul style="list-style-type: none"> • STOP Fuse • Stop light switch • Actuator magnetic clutch • Harness or connector between cruise control ECU and actuator magnetic clutch, actuator magnetic clutch and body ground • Cruise control ECU

WIRING DIAGRAM

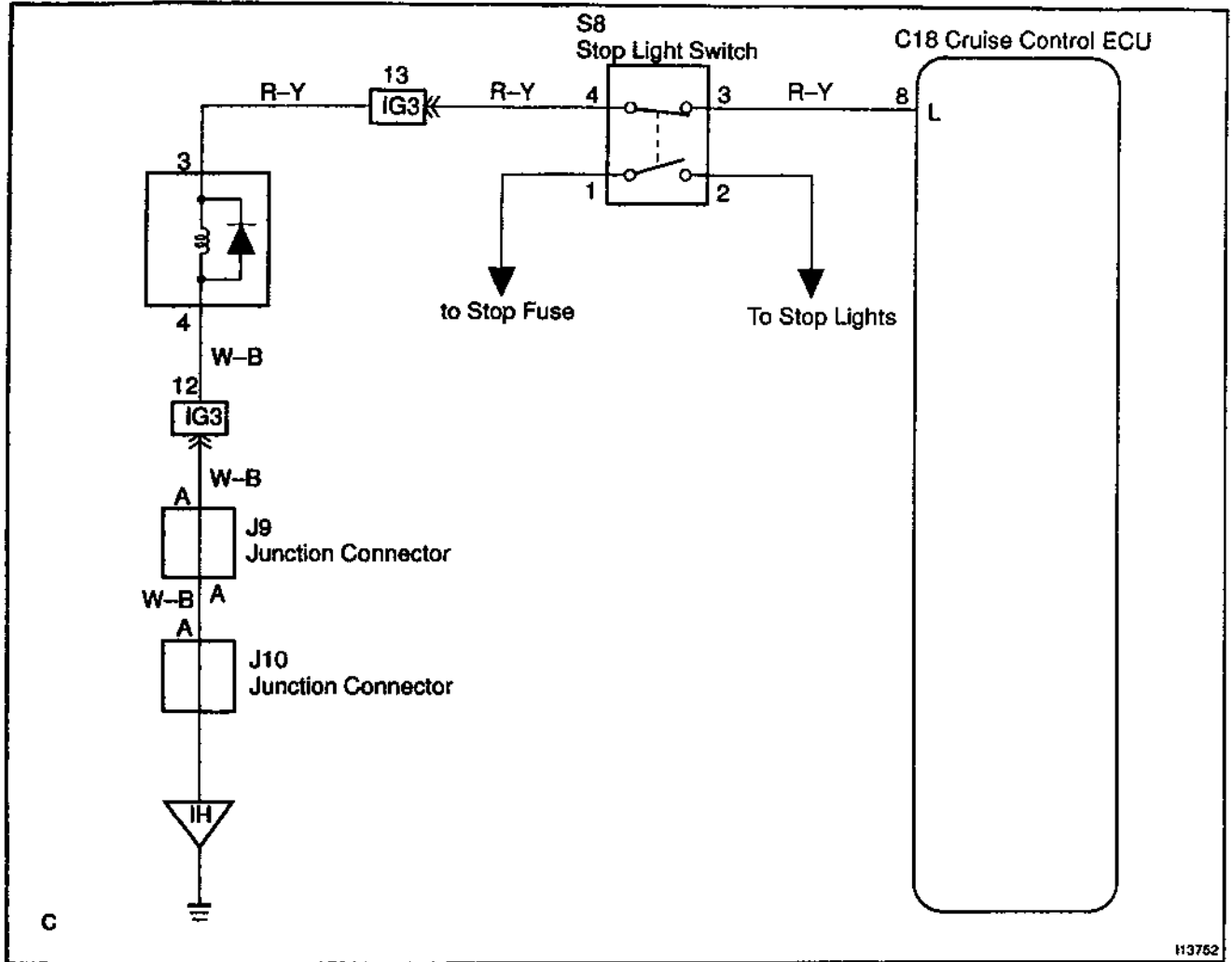

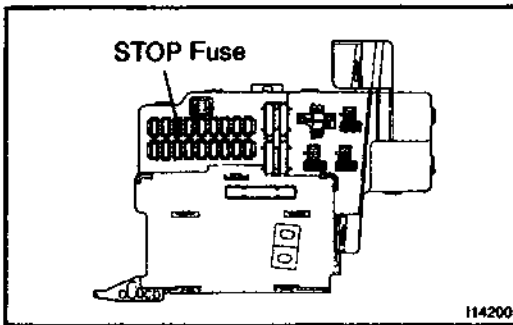
INSPECTION PROCEDURE**1 Check STOP fuse.****PREPARATION:**

- (a) Turn ignition switch OFF.
- (b) Remove the STOP fuse from instrument panel junction block.

CHECK:

Check fuse continuity.

OK:

There is continuity.

NG

Replace STOP fuse.

OK

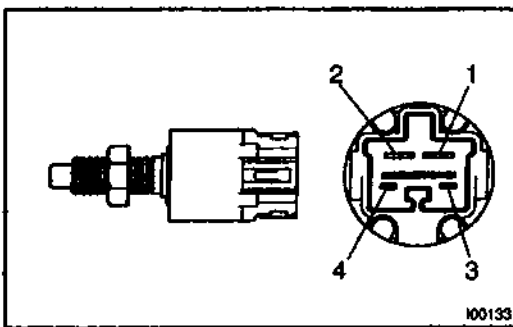
2 Check stop light switch.**PREPARATION:**

Disconnect the stop light switch connector.

CHECK:

Check continuity between terminals.

Switch position	Continuity
Switch pln free (Brake pedal depressed)	1 - 2
Switch pln pushed in (Brake pedal released)	3 - 4

NG

Replace stop light switch.

OK

3 Check resistance between terminals L and GND of actuator magnetic clutch.

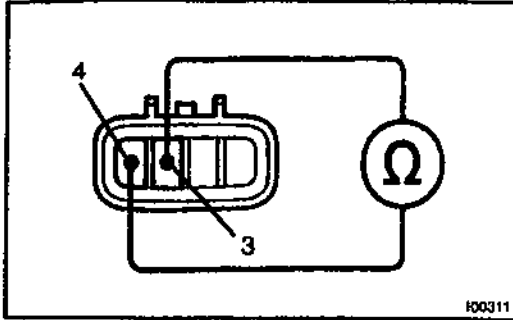
**PREPARATION:**

- (a) Turn ignition switch OFF.
- (b) Disconnect the actuator connector.

CHECK:

Measure resistance between terminals 3 and 4.

OK:

Resistance: 34.65 – 42.35 Ω

NG

Replace cruise control actuator.

OK

4 Check for open and short in harness and connectors between cruise control ECU and actuator magnetic clutch, actuator magnetic clutch and body ground (See page IN-30).

NG

Repair or replace harness or connector.

OK

Check and replace cruise control ECU (See page IN-30).

DTC	14	Actuator Mechanical Malfunction
------------	-----------	----------------------------------------

CIRCUIT DESCRIPTION

The circuit detects the rotation position of the actuator control plate and sends a signal to the ECU.

DTC No.	Detection Item	Trouble Area
14	Cruise control actuator mechanical malfunction.	<ul style="list-style-type: none"> • Actuator lock: (motor, arm) • Actuator motor • Cruise control ECU

WIRING DIAGRAM

See page DI-498.

INSPECTION PROCEDURE

1	Check cruise control actuator arm locking operation
----------	------------------------------------------------------------

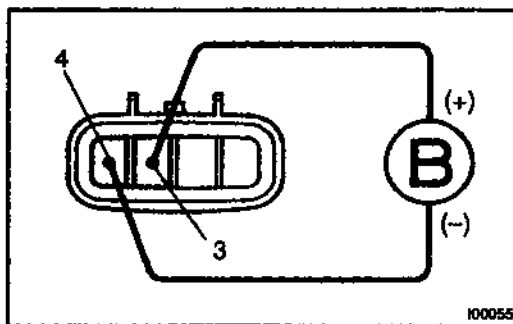

PREPARATION:

- (a) Turn ignition switch OFF.
- (b) Disconnect the actuator connector.

CHECK:

- (a) Connect the positive (+) lead from the battery to the terminal 3 of actuator and the negative (-) lead to terminal 4.

NOTICE:

Do not connect the high tension cables to the wrong battery terminal. The cruise control actuator will be damaged.

- (b) Move the control plate by hand.

OK:

Control plate doesn't move.

NG

Replace cruise control actuator.

OK

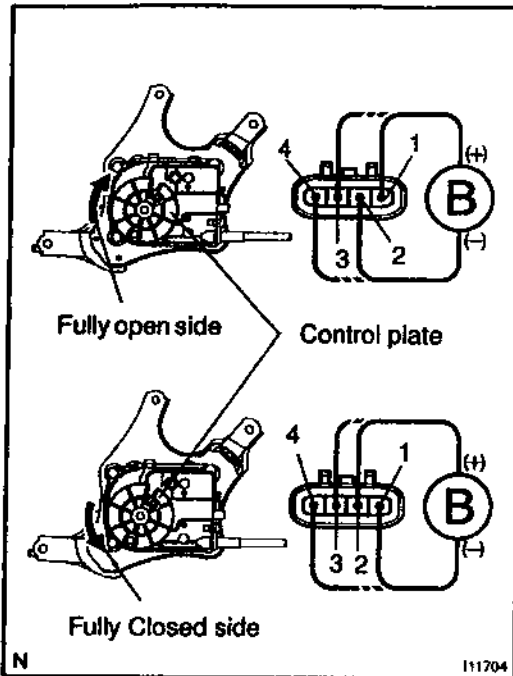
2 Check cruise control actuator operation.**PREPARATION:**

- (a) Turn ignition switch OFF.
- (b) Disconnect the actuator connector.

CHECK:

Connect the positive (+) lead from the battery to terminals 1 and 3 of actuator, connect the negative (-) lead to terminals 2 and 4 of actuator.

OK:

Control arm moves to fully open side

CHECK:

Connect the positive (+) lead from the battery to terminals 2 and 3 of actuator, connect the negative (-) lead to terminals 1 and 4 of actuator.

OK:

Control arm moves to fully closed side

NG

Replace cruise control actuator.

OK

3 Check harness and connector between cruise control ECU and cruise control actuator (See page IN-30).

NG

Repair or replace harness or connector.

OK

Check and replace cruise control ECU (See page IN-30).

DTC	21	Open in Vehicle Speed Sensor Circuit
------------	-----------	---------------------------------------------

CIRCUIT DESCRIPTION

The signal from the vehicle speed sensor circuit is sent to cruise control ECU as vehicle speed signal.

The rotor shaft is driven by the gear of the transmission.

For each rotation of the shaft, the vehicle speed sensor sends a 4-pulse signal through the combination meter to the cruise control ECU (See the following installation).

This signal is converted inside the combination meter and sent as a 4-pulse signal to the cruise control ECU. The ECU calculates the vehicle speed from this pulse frequency.

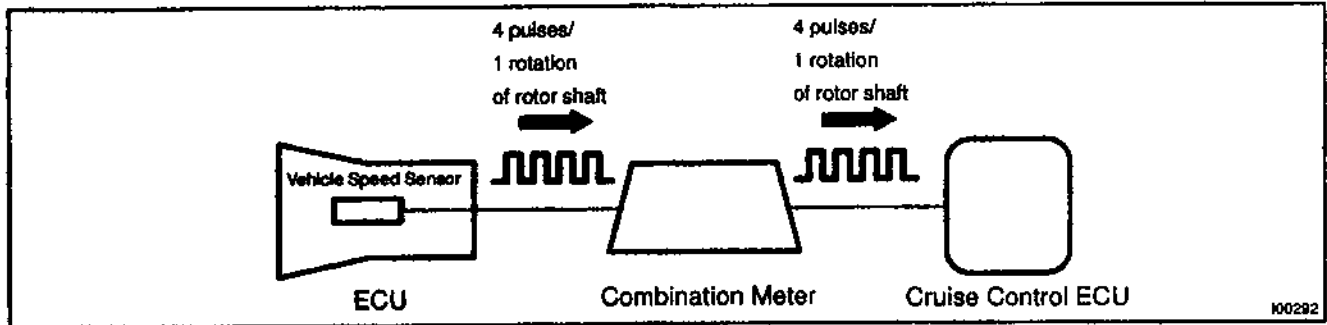



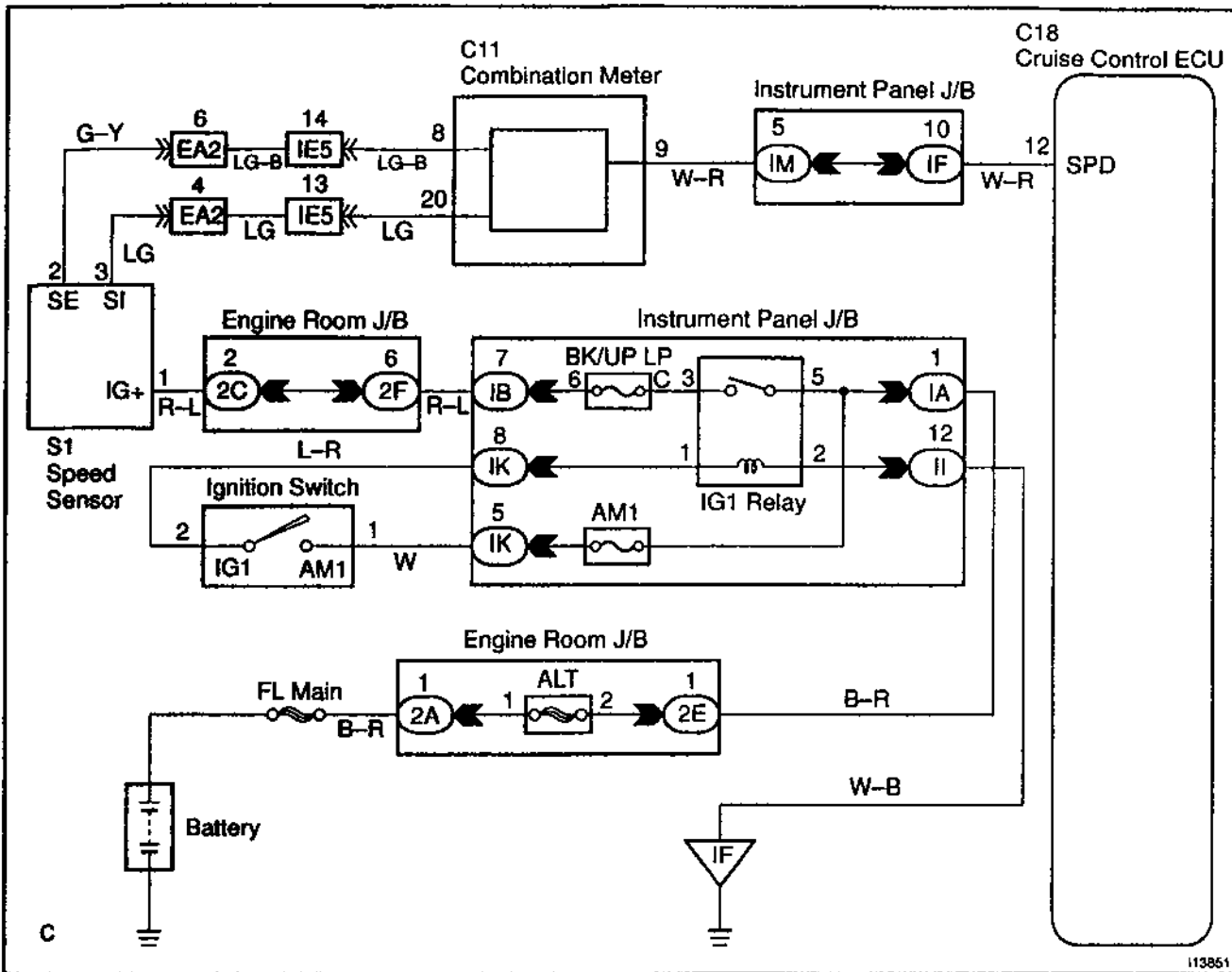

DTC No.	Detection Item	Trouble Area
21	Speed signal is not input to the cruise control ECU while cruise control is set.	<ul style="list-style-type: none"> • Combination meter • Harness or connector between cruise control ECU and combination meter, combination meter and vehicle speed sensor • Vehicle speed sensor • Cruise control ECU

WIRING DIAGRAM



INSPECTION PROCEDURE

1	Input signal check.
----------	----------------------------

Input Signal	Indicator Light Blinking Pattern
Drive at about 40 km/h (25 mph) or below	Light ON  OFF 
Drive at about 40 km/h (25 mph) or higher	Light ON  OFF 

CHECK:

- (a) See input signal check on page DI-485.
 (b) Check indicator light operation when driving with vehicle speed above 40 km/h (25 mph), and with vehicle speed below 40 km/h (25 mph).

OK:

Vehicle speed above 40 km/h (25 mph):
 Indicator light blinks
 Vehicle speed below 40 km/h (25 mph):
 Indicator light stays on

OK

Check and replace cruise control ECU (See page IN-30).

NG

2	Check speedometer circuit (See Combination meter troubleshooting on page BE-42).
----------	-----------------------------------------------------------------------------------------

NG

Repair or replace harness, connector or combination meter assembly.

OK

3	Check harness and connector between cruise control ECU and combination meter, combination meter and vehicle speed sensor (See page IN-30).
----------	---------------------------------------------------------------------------------------------------------------------------------------------------

NG

Repair or replace harness or connector.

OK

4 Check vehicle speed sensor (See page BE-46).

NG Replace vehicle speed sensor.

OK

Check and replace cruise control ECU (See page IN-30).

DTC	23	Vehicle Speed Signal Abnormal
------------	-----------	--------------------------------------

CIRCUIT DESCRIPTION

See page DI-504.

DTC No.	Detection Item	Trouble Area
23	Vehicle speed sensor pulse is abnormal.	<ul style="list-style-type: none"> • Vehicle speed sensor • Cruise control ECU

WIRING DIAGRAM

See page DI-504.

INSPECTION PROCEDURE

1	Check vehicle speed sensor (See page BE-46).
----------	-----------------------------------------------------

NG

Replace vehicle speed sensor.

OK

Check and replace cruise control ECU (See page IN-30).

Control Switch Circuit (Cruise Control Switch)

CIRCUIT DESCRIPTION

This circuit carries the SET/COAST, RESUME/ACCEL and CANCEL signals (each voltage) to the ECU.

WIRING DIAGRAM

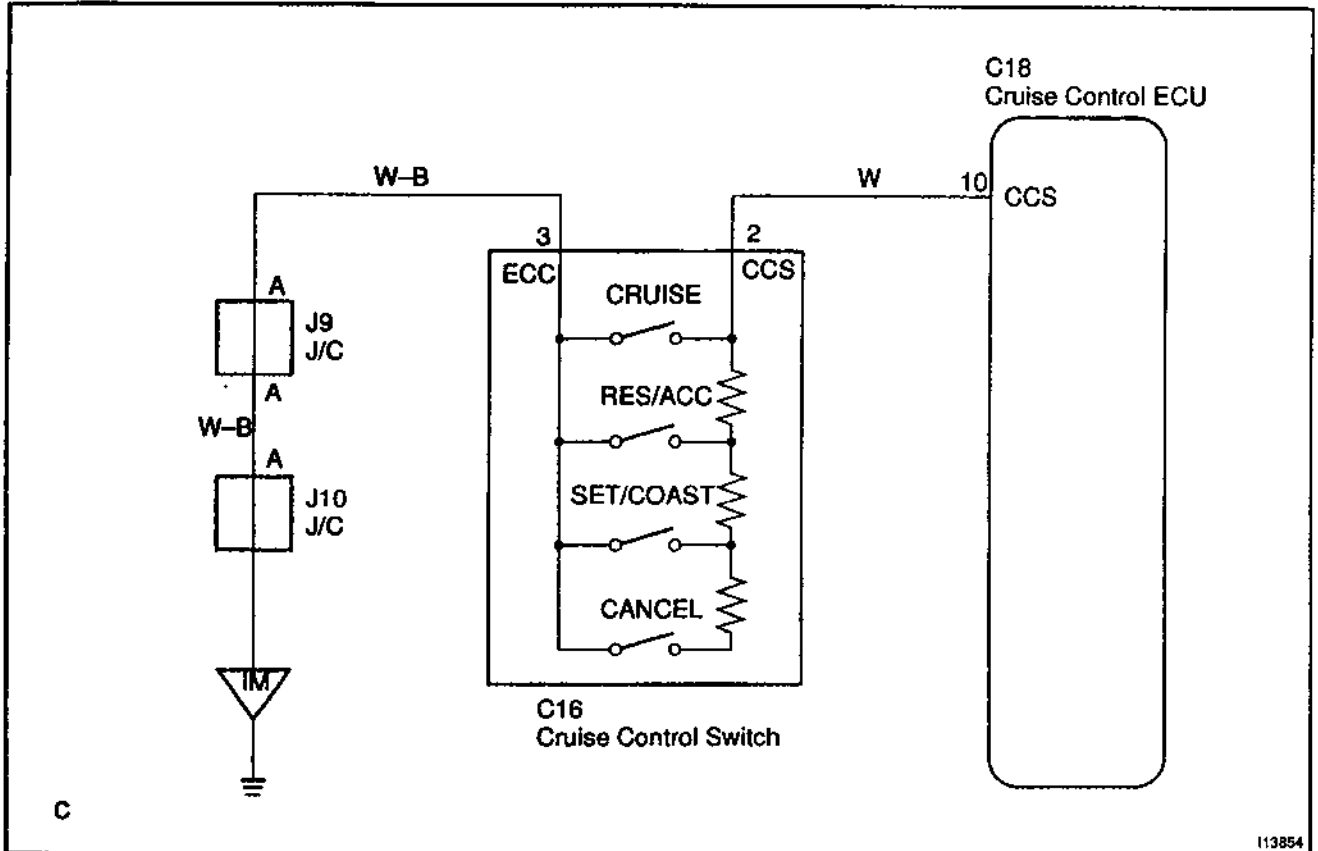

C

INSPECTION PROCEDURE

1 Input signal check.

Input Signal	Indicator Light Blinking Pattern
SET/COAST switch	ON OFF 2 Pulses
RESUME/ACCEL switch	ON OFF 3 Pulses
CANCEL switch	ON OFF SW OFF SW ON

PREPARATION:

See input signal check on page DI-485.

CHECK:

Check the indicator light operation when each of the SET/COAST, RESUME/ACCEL and CANCEL is turned on.

OK:

SET/COAST, RESUME/ACCEL switch

The signals shown in the table on the left should be output when each switch is ON. The signal should disappear when the switch is turned OFF.

CANCEL switch

The indicator light goes off when the cancel switch is turned ON.

OK Wait and see.

NG

2 Check voltage between terminals CCS of cruise control ECU connector and body ground.

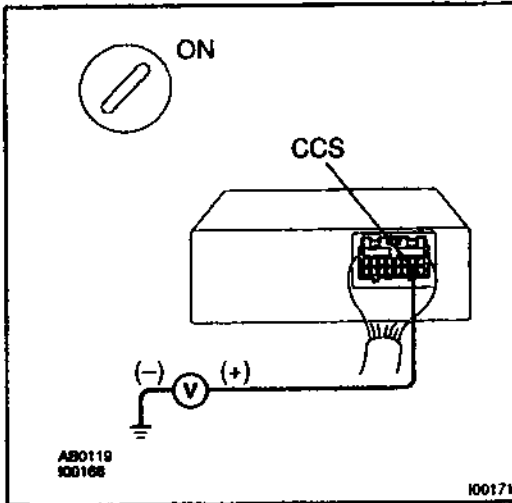

PREPARATION:

- (a) Remove the ECU with connector still connected.
- (b) Turn ignition switch ON.

CHECK:

Measure voltage between terminals 18 of ECU connector and body ground, when each of the SET/COAST, RESUME/ACCEL and CANCEL is turned ON.

Switch position	Resistance (V)
Neutral	10 - 16 V
RES/ACC	0.8 - 3.7 V
SET/COAST	2.5 - 6.3 V
CANCEL	4.2 - 8.8 V

NG Proceed to next circuit inspection shown in problem symptom table (See page DI-494).

OK

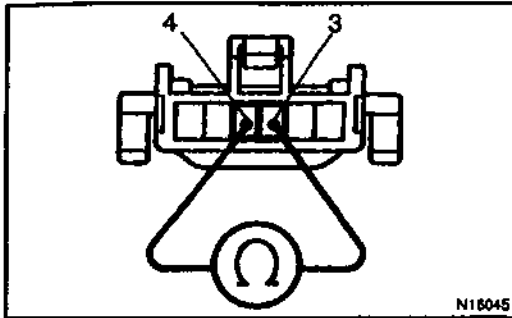
3 Check control switch.**PREPARATION:**

- (a) Remove steering wheel center pad.
- (b) Disconnect the control switch connector.

CHECK:

Measure resistance between terminals 3 and 4 of control switch connector when control switch is operated.

Switch position	Resistance (Ω)
Neutral	∞ (No continuity)
RES/ACC	50 - 80
SET/COAST	180 - 220
CANCEL	400 - 440

NG**Replace control switch.****OK****4 Check harness and connector between cruise control ECU and cruise control switch, cruise control switch and body ground (See page IN-30).****NG****Repair or replace harness or connector.****OK****5 Input signal check (See step 1).****OK****Wait and see.****NG**

Check and replace cruise control ECU (See page IN-30).

Idle Signal Circuit

CIRCUIT DESCRIPTION

When the idle switch is turned ON, a signal is sent to the ECU. The ECU uses this signal to correct the discrepancy between the throttle valve position and the actuator position sensor value to enable accurate cruise control at the set speed. If the idle switch is malfunctioning, problem symptoms also occur in the engine, so also inspect the engine.

WIRING DIAGRAM

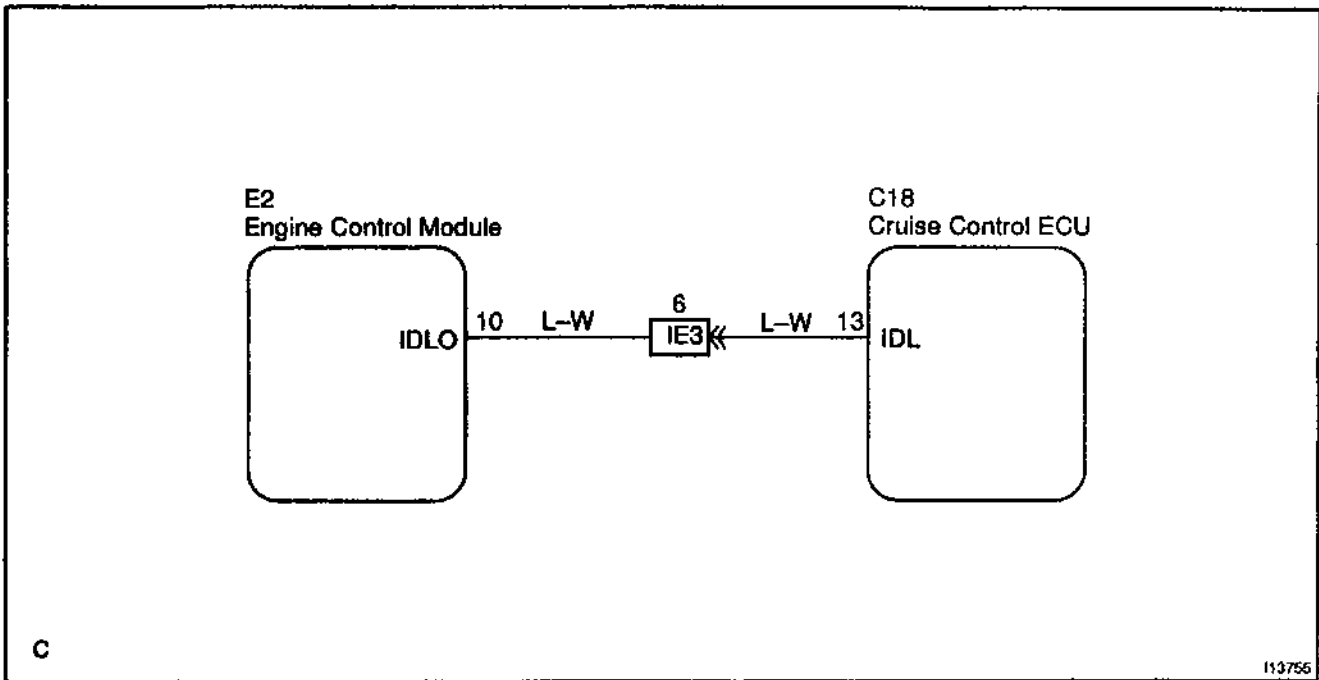

INSPECTION PROCEDURE

1 Check voltage between terminal IDL of cruise control ECU connector and body ground.

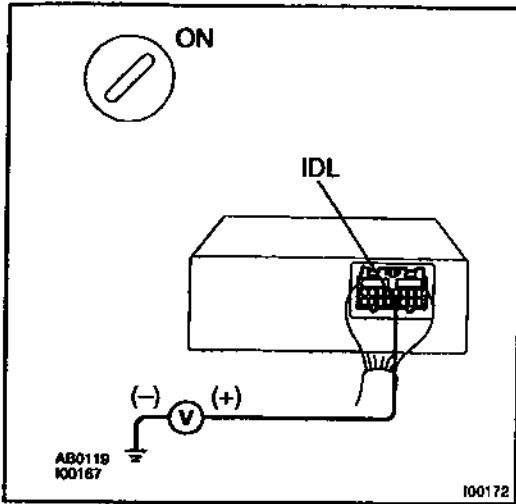

PREPARATION:

- (a) Remove the ECU with connector still connected.
- (b) Disconnect the ECM connector.
- (c) Turn ignition switch ON.

CHECK:

Measure voltage between terminal IDL of ECU connector and body ground when the throttle valve is fully closed and fully opened.

OK:

Throttle valve position	Voltage
Fully opened	10 - 14 V
Fully closed	Below 2 V

OK Proceed to next circuit inspection shown in problem symptom table (See page DI-494).

NG

2 Check harness and connector between ECM and throttle position sensor (See page IN-30).

NG Repair or replace harness or connector.

OK

3 Check throttle position sensor circuit (See page DI-38).

NG Replace throttle position sensor.

OK

4	Check for open and short in harness and connector between cruise control ECU and ECM (See page IN-30).
---	--------------------------------------------------------------------------------------------------------

NG

Repair or replace harness or connector.

OK

Check and replace cruise control ECU (See page IN-30).

Stop Light Switch Circuit

CIRCUIT DESCRIPTION

When the brake pedal is depressed, the stop light switch sends a signal to the ECU. When the ECU receives this signal, it cancels the cruise control.

A fail-safe function is provided so that the cancel functions normally, even if there is a malfunction in the stop light signal circuit.

The cancel conditions are: Battery positive voltage at terminal STP-

When the brake is ON, battery positive voltage normally is applied through the STOP fuse and stop light switch to terminal STP- of the ECU, and the ECU turns the cruise control OFF.

If the harness connected to terminal STP- has an open circuit, terminal STP- will have battery positive voltage and the cruise control will be turned OFF.

Also, when the brake is ON, the magnetic clutch circuit is cut mechanically by the stop light switch, turning the cruise control OFF. (See page DI-498 for operation of the magnetic clutch)

WIRING DIAGRAM

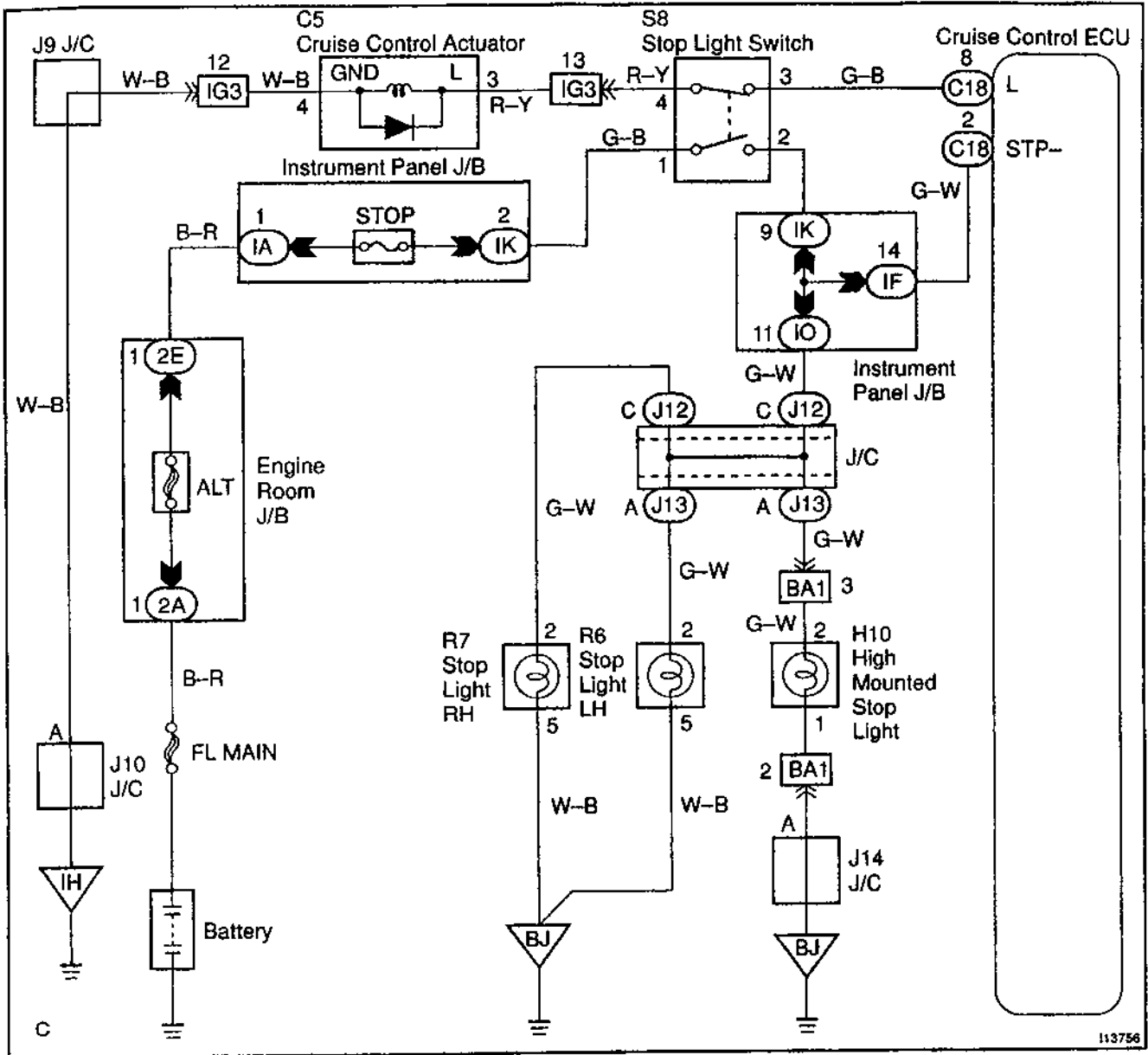

INSPECTION PROCEDURE

1	Check operation of stop light.
----------	---------------------------------------

CHECK:

Check that stop light comes ON when brake pedal is depressed, and turns OFF when brake pedal is released.

NG	Check stop light system (See page BE-2).
-----------	-------------------------------------------------

OK

2	Input signal check.
----------	----------------------------

CHECK:

- (a) See input signal check on DI-485.
- (b) Check the indicator light when the brake pedal is depressed.

OK:

The indicator light goes OFF when the brake pedal is depressed.

Input Signal	Indicator Light Blinking Pattern						
Stop Light switch ON	<table style="margin-left: auto; margin-right: auto;"> <tr> <td style="text-align: center;">OFF</td> <td style="text-align: center;">SW OFF</td> </tr> <tr> <td style="text-align: center;">-Light</td> <td style="text-align: center;">[]</td> </tr> <tr> <td style="text-align: center;">ON</td> <td style="text-align: center;">----- SW ON</td> </tr> </table>	OFF	SW OFF	-Light	[]	ON	----- SW ON
OFF	SW OFF						
-Light	[]						
ON	----- SW ON						

OK	Proceed to next circuit inspection shown in problem symptom table (See page DI-494).
-----------	---------------------------------------------------------------------------------------------

NG

3 Check voltage between terminal STP- of cruise control ECU connector and body ground.

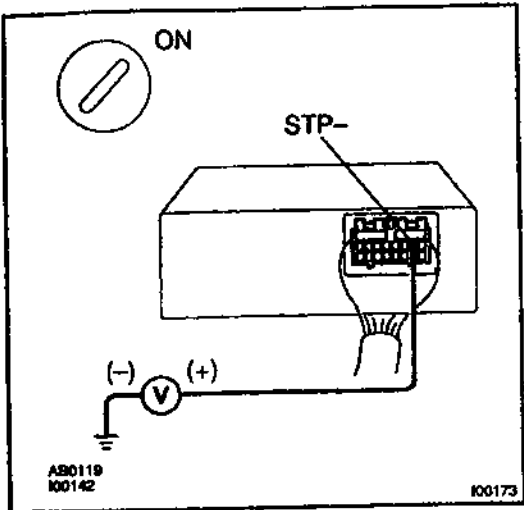

PREPARATION:

- (a) Remove the ECU with connectors still connected.
- (b) Turn ignition switch ON.

CHECK:

Measure voltage between terminal STP- of cruise control ECU connector and body ground, when the brake pedal is depressed and released.

OK:

Depressed	10 - 14 V
Released	Below 1 V

OK Proceed to next circuit inspection shown in problem symptom table (See page DI-494).

NG

4 Check for open in harness and connectors between terminal STP- of cruise control ECU and stop light switch (See page IN-30).

NG Repair or replace harness or connector.

OK

Check and replace cruise control ECU (See page IN-30).

Electronically Controlled Transmission Communication Circuit

CIRCUIT DESCRIPTION

When driving uphill under the cruise control, in order to reduce shifting due to ON-OFF overdrive operation and to provide smooth driving, when down shifting in the electronically controlled transmission occurs, a signal to prevent upshift until the end of the uphill slope is sent from the cruise control ECU to the electronically controlled transmission.

Terminal ECT of the cruise control ECU detects the shift change signal (output to electronically controlled transmission No. 2 solenoid) from the ECM.

If the vehicle speeds down, also when terminal ECT of the cruise control ECU receives down shifting signal, it sends a signal from terminal OD to ECM to cut overdrive until the end of the uphill slope, and the gear shifts are reduced and gear shift points in the electronically controlled transmission are changed.

WIRING DIAGRAM

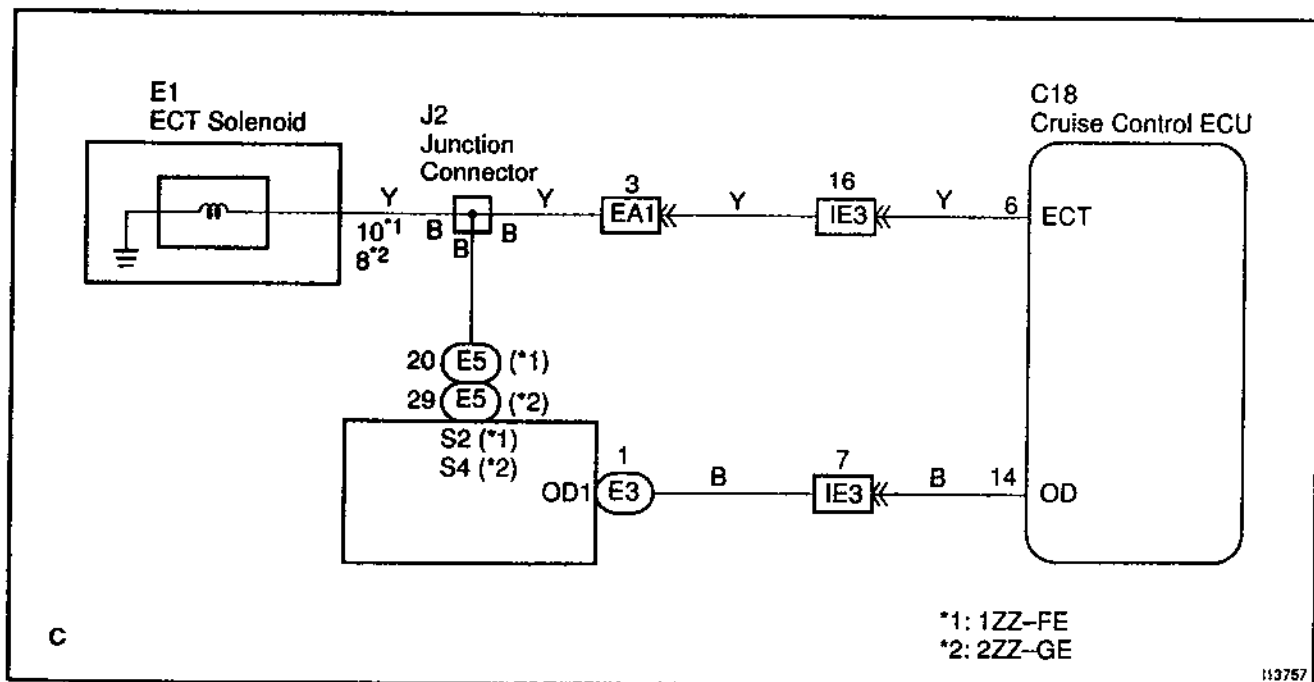

INSPECTION PROCEDURE

1 Check operation of overdrive.

PREPARATION:

Test drive after engine warms up.

CHECK:

Check that overdrive ON ↔ OFF occurs by operation of OD switch ON-OFF.

NG

Check and repair electronically controlled transmission (See page DI-155 or DI-218).

OK

2 Check voltage between terminal OD of harness side connector of cruise control ECU and body ground.

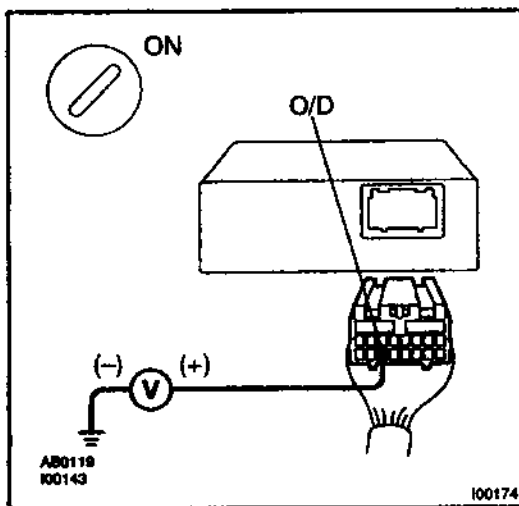
**PREPARATION:**

- Remove the ECU with connector still connected.
- Turn ignition switch ON.
- Disconnect the ECU connector.

CHECK:

Measure voltage between terminal OD of harness side connector of ECU and body ground.

OK:

Voltage: 10 – 14 V

NG

Go to step 5.

OK

3 Check voltage between terminal ECT of cruise control ECU connector and body ground (On test drive).

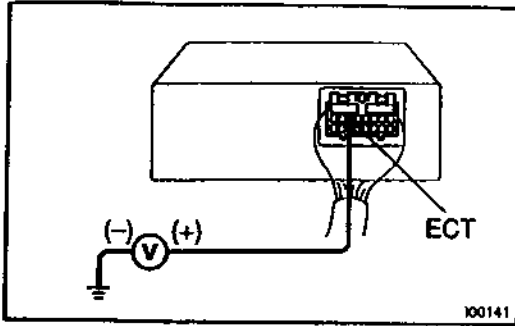

PREPARATION:

- (a) Connect the ECU connector.
- (b) Test drive after engine warms up.

CHECK:

Check voltage between terminal ECT of ECU connector and body ground when OD switch is ON and OFF.

OK:

OD switch position	Voltage
ON	8 - 14 V
OFF	Below 0.5 V

OK Proceed to next circuit inspection shown in problem symptom table (See page DI-494).

NG

4 Check harness and connector between terminal ECT of cruise control ECU and electronically controlled transmission solenoid (See page IN-30).

NG Repair or replace harness or connector.

OK

Check and replace cruise control ECU.

5 Check harness and connector between terminal OD of cruise control ECU and terminal OD1 of ECM (See page IN-30).

NG Repair or replace harness or connector.

OK

Check and replace cruise control ECU (See page IN-30).

Park/Neutral Position Switch Circuit

CIRCUIT DESCRIPTION

When the shift position is except D, a signal is sent from the park/neutral position switch to the ECU. When this signal is input during cruise control driving, the ECU cancels the cruise control.

WIRING DIAGRAM

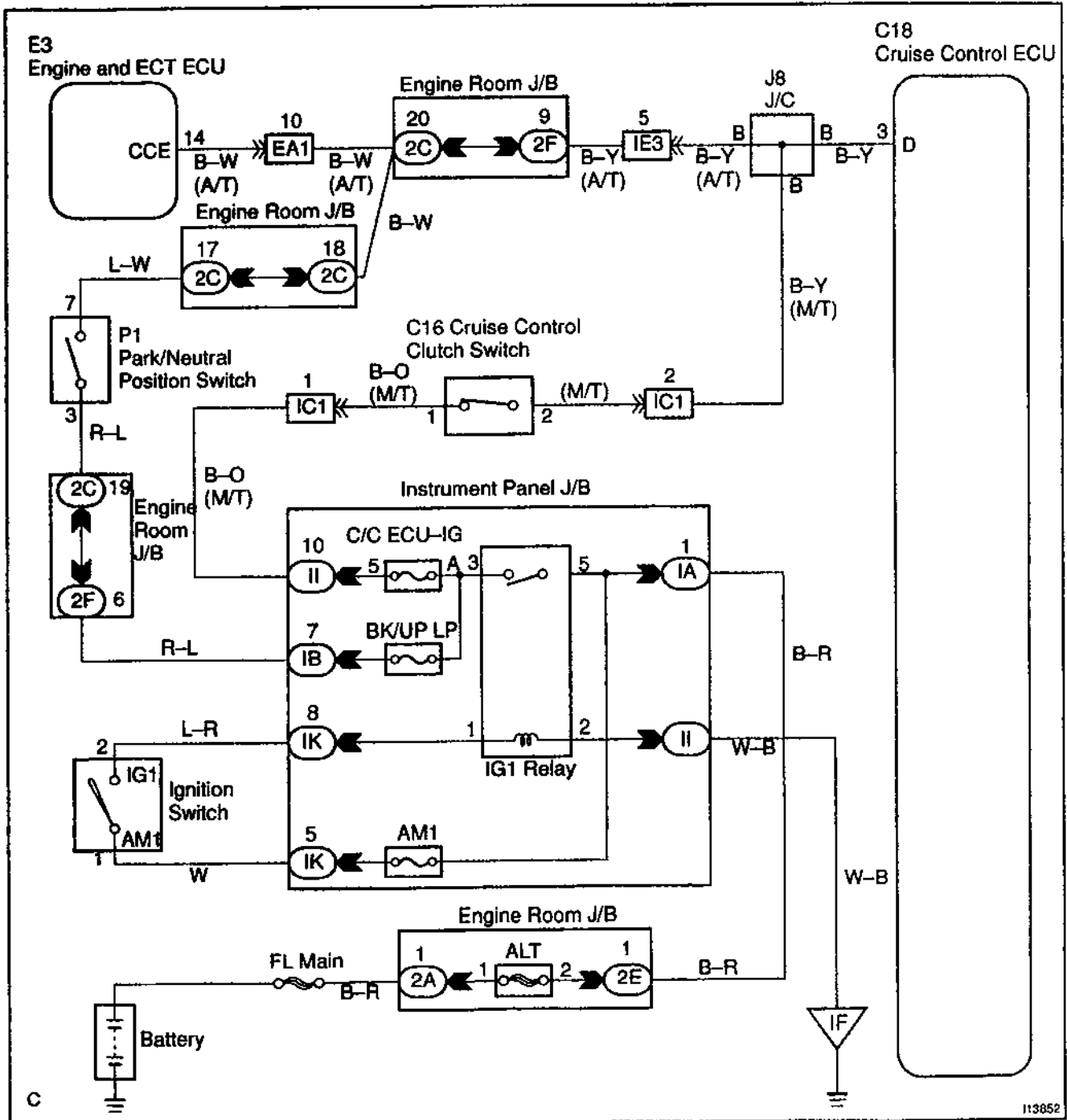

INSPECTION PROCEDURE

1	Check starter operation.
---	---------------------------------

CHECK:

Check that the starter operates normally and that the engine starts.

NG → Proceed to engine troubleshooting (See page DI-1).

OK

2	Input signal check.
---	----------------------------

Input Signal	Indicator Light Blinking Pattern								
Turn PNP switch OFF (Shift to positions except D)	<table style="border: none;"> <tr> <td style="padding-right: 5px;">Light</td> <td style="padding-right: 5px;">ON</td> <td style="padding-right: 5px;">SW ON</td> <td style="padding-right: 5px;">ON</td> </tr> <tr> <td></td> <td style="padding-right: 5px;">OFF</td> <td style="padding-right: 5px;">---</td> <td style="padding-right: 5px;">SW OFF</td> </tr> </table>	Light	ON	SW ON	ON		OFF	---	SW OFF
Light	ON	SW ON	ON						
	OFF	---	SW OFF						

PREPARATION:

See input signal check on page DI-485.

CHECK:

Check the indicator light when shifting into positions except D.

OK:

The indicator light goes off when shifting into positions except D.

OK → Proceed to next circuit inspection shown in problem symptom table (See page DI-494).

NG

3 Check voltage between terminal D of cruise control ECU connector and body ground.

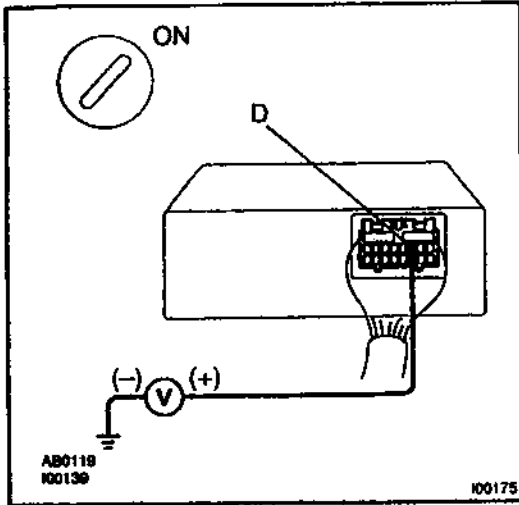

PREPARATION:

Turn ignition switch ON.

CHECK:

Measure voltage between terminal D of ECU connector and body ground when shifting into D position and other positions.

OK:

Shift Position	Voltage
D position	10 - 14 V
Other positions	Below 1 V

OK Proceed to next circuit inspection shown in problem symptom table (See page DI-494).

NG

4 Check harness and connector between cruise control ECU and park/neutral position switch (See page IN-30).

NG Repair or replace harness or connector.

OK

Check and replace cruise control ECU (See page IN-30).

Clutch Switch Circuit

CIRCUIT DESCRIPTION

When the clutch pedal is depressed, the clutch switch sends a signal to the cruise control ECU. When the signal is input to the cruise control ECU during cruise control driving, the cruise control ECU cancels cruise control.

WIRING DIAGRAM

Refer to PNP switch circuit on page DI-522.

INSPECTION PROCEDURE

1	Check starter operation.
----------	---------------------------------

CHECK:

Check that the starter operates normally and that the engine starts.

NG

Proceed to engine troubleshooting.

OK

2	Input signal check.
----------	----------------------------

Input Signal	Indicator Light Blinking Pattern
Clutch switch OFF (Depress clutch pedal)	<div style="display: flex; align-items: center;"> <div style="margin-right: 10px;">Light</div> <div style="display: flex; align-items: center;"> <div style="border: 1px solid black; padding: 2px; margin-right: 5px;">ON</div> <div style="margin-right: 10px;">SW ON</div> </div> <div style="border: 1px solid black; padding: 2px; margin-left: 10px;">SW OFF</div> </div> <div style="margin-top: 5px; padding-left: 20px;">OFF-----</div>

PREPARATION:

See input signal check on page DI-485.

CHECK:

Check the indicator lights when clutch pedal is depressed.

OK:

The indicator light goes off when shifting into clutch pedal is depressed.

OK

Proceed to next circuit inspection shown in problem symptom table (See page DI-494).

NG

3 Check voltage between terminal D of cruise control ECU and body ground.

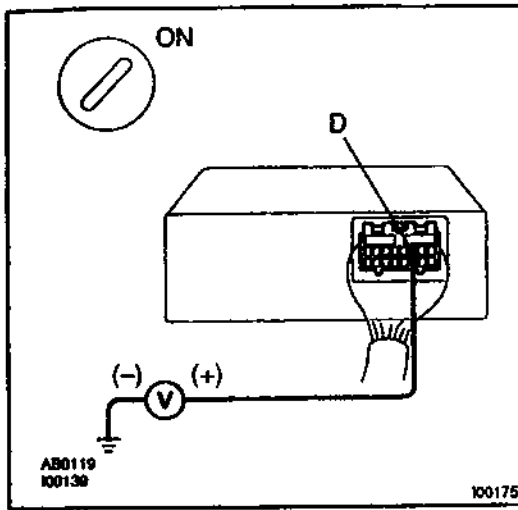

PREPARATION:

Turn ignition switch ON.

CHECK:

Measure voltage between terminal D of cruise control ECU connector and body ground when clutch pedal is depressed and pushed in.

OK:

Shift Position	Voltage
Clutch pedal depressed	10 - 14 V
Clutch pedal pushed in	Below 1 V

OK

Proceed to next circuit inspection shown in problem symptom table (See page DI-494).

NG

4 Check for open in harness and connector between ECU and GAUGE fuse (See page IN-30).

NG

Repair or replace harness or connector.

OK

Check and replace cruise control ECU (See page IN-30).

ECU Power Source Circuit

CIRCUIT DESCRIPTION

The ECU power source supplies power to the actuator and sensors, etc, when terminal GND and the cruise control ECU case are grounded.

WIRING DIAGRAM

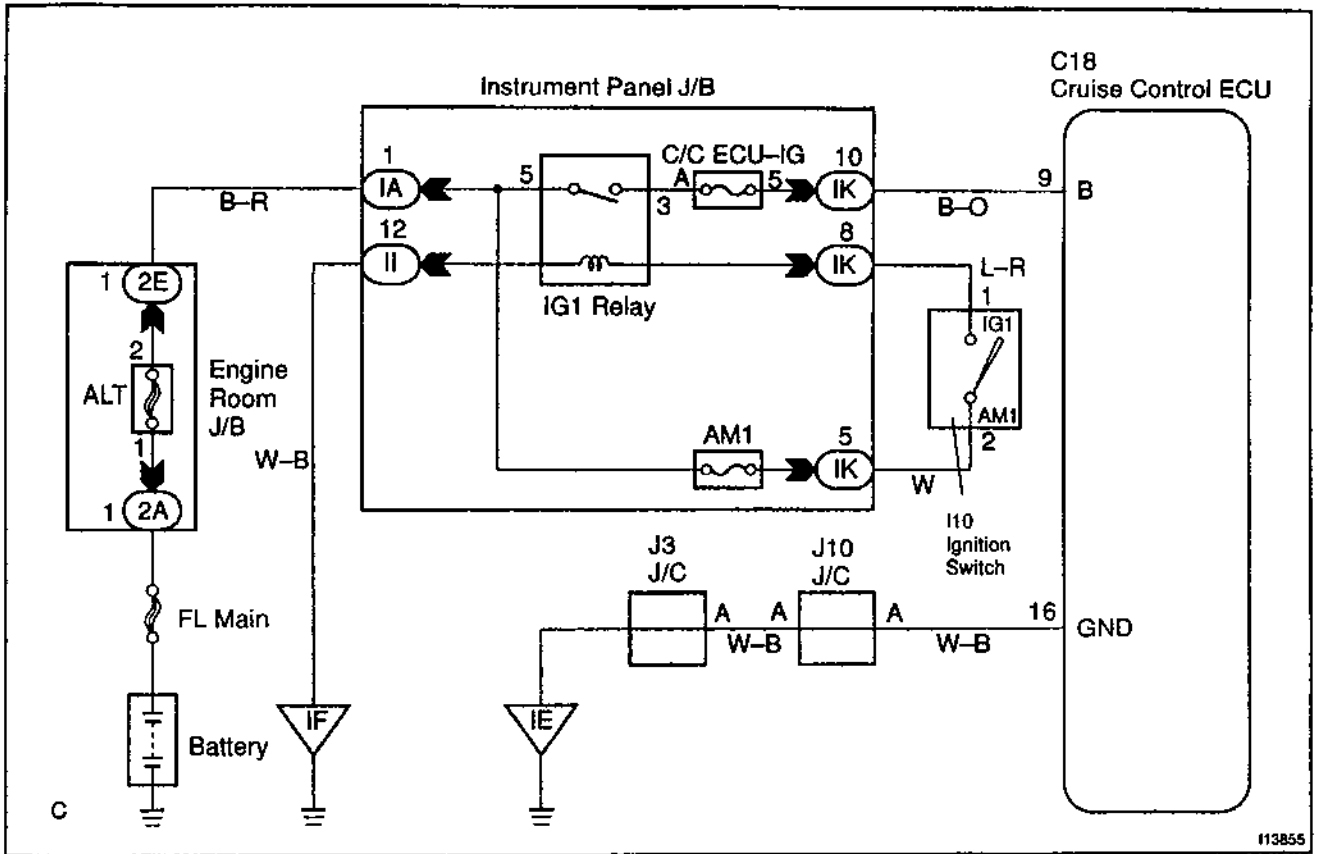

INSPECTION PROCEDURE

1 Check ECU-IG fuse.

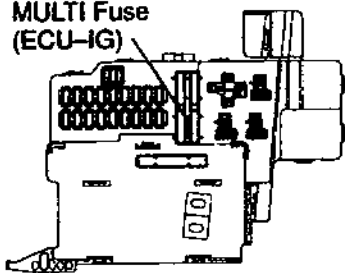
MULTI Fuse
(ECU-IG)

114200

PREPARATION:

Remove the ECU-IG fuse from instrument panel junction block.

CHECK:

Check continuity of ECU-IG fuse.

OK:

Continuity

NG

Check for short in all the harness and components connected to ECU-IG fuse.

OK

2 Check voltage between terminals B and GND of cruise control ECU connector.

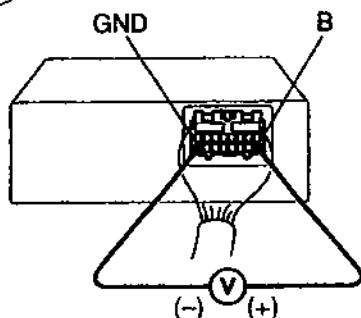
AB0119
100147

100178

PREPARATION:

(a) Remove the ECU with connector still connected.

(b) Turn ignition switch ON.

CHECK:

Measure voltage between terminals B and GND of ECU connector.

OK:

Voltage: 10 - 14 V

OK

Proceed to next circuit inspection shown in problem symptom table (See page DI-494).

NG

- 3** Check resistance between terminal GND of cruise control ECU connector and body ground.

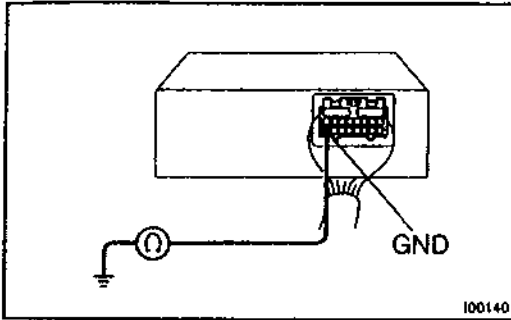
**CHECK:**

Measure resistance between terminal GND of ECU connector and body ground.

OK:

Resistance: Below 1 Ω

NG

Repair or replace harness or connector.

OK

Check and repair harness and connector between cruise control ECU and battery (See page IN-30).

CRUISE MAIN Indicator Light Circuit

CIRCUIT DESCRIPTION

When the cruise control main switch is turned ON, CRUISE MAIN indicator light lights up.

WIRING DIAGRAM

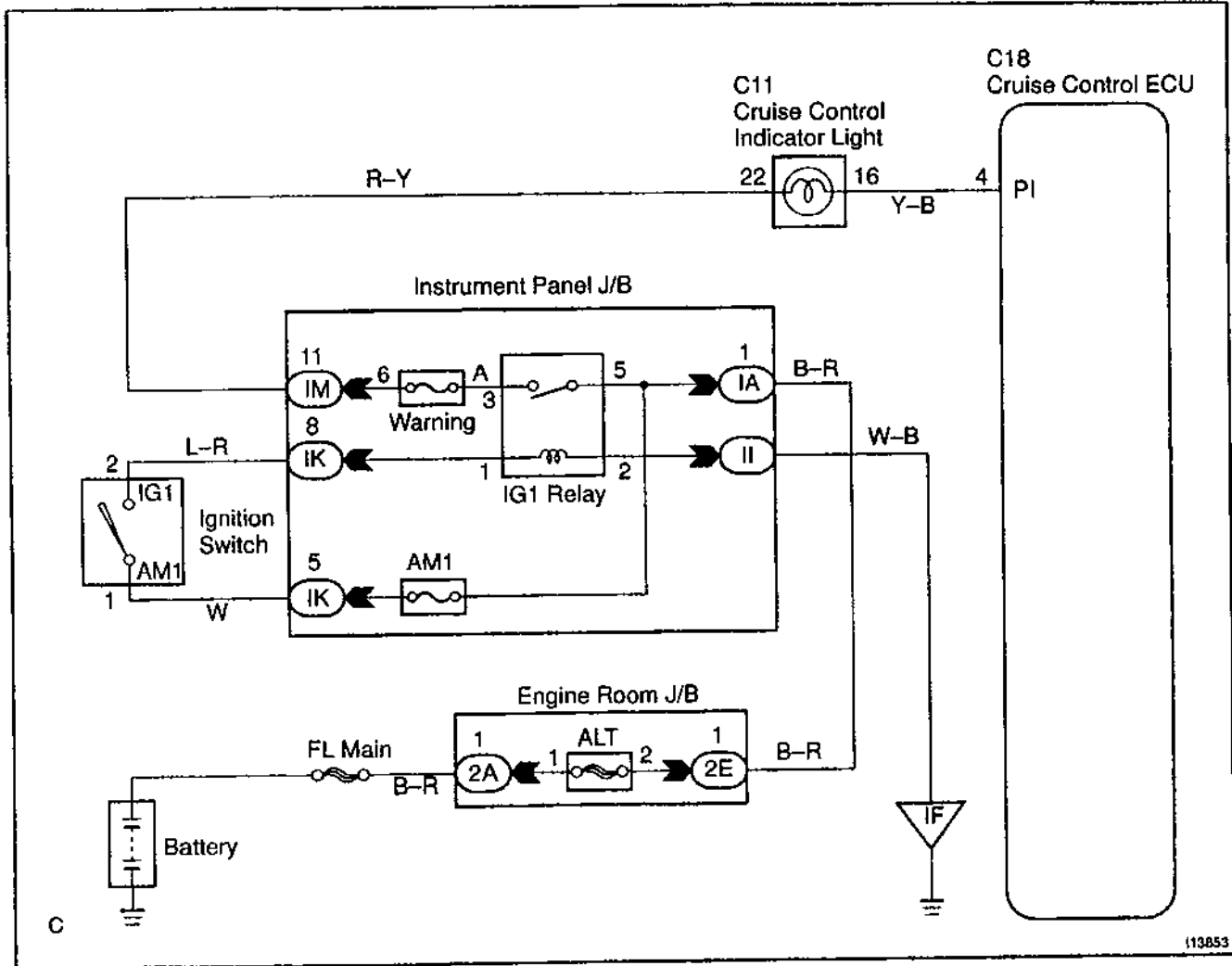

C

113853

INSPECTION PROCEDURE

- 1** Check voltage between terminals PI and GND of cruise control ECU connector.

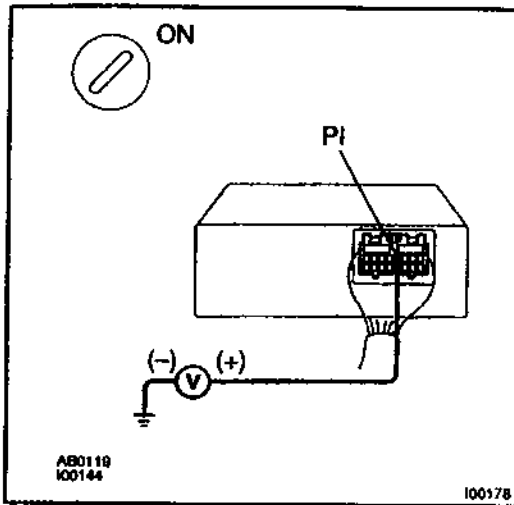
**PREPARATION:**

Turn ignition switch ON.

CHECK:

Measure voltage between terminals PI and GND of cruise control ECU connector when main switch is ON and OFF.

OK:

Switch position	Voltage
OFF	10 ~ 16 V
ON	Below 1.2 V

OK

Proceed to next circuit inspection shown in problem symptom table (See page DI-494).

NG

- 2** Check combination meter (See page BE-42).

NG

Replace combination meter.

OK

Check and replace cruise control ECU (See page IN-30).

Diagnosis Circuit

CIRCUIT DESCRIPTION

This circuit sends a signal to the ECU that outputs DTC.

WIRING DIAGRAM

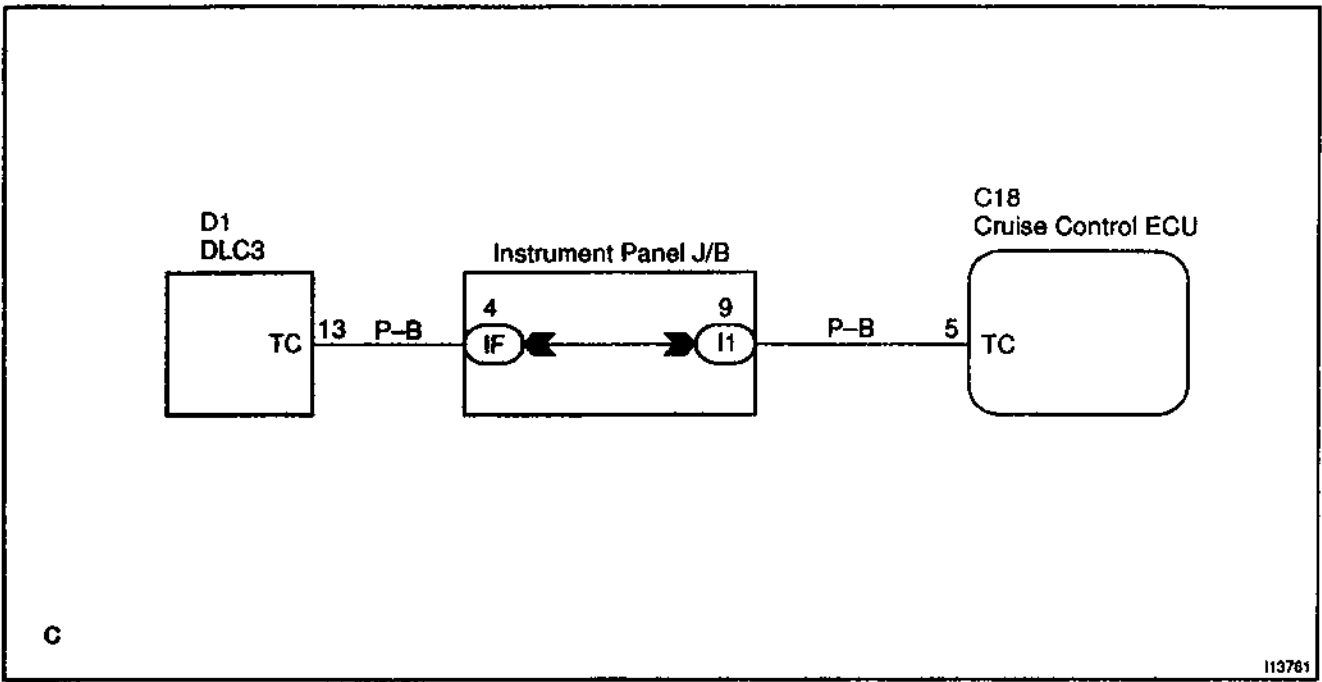

INSPECTION PROCEDURE

- 1 Check voltage between terminals Tc and E₁ of DLC3.**

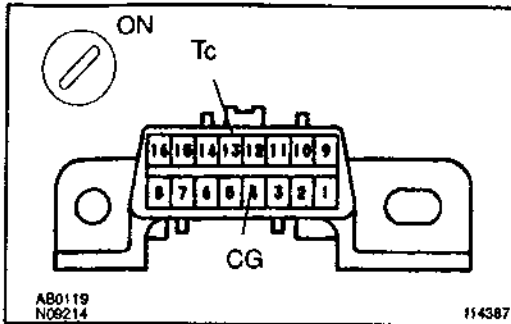
**PREPARATION:**

Turn ignition switch ON.

CHECK:

Measure voltage between terminals Tc and E₁ of DLC3.

OK:

Voltage: 10 - 14 V

OK

Proceed to next circuit inspection shown in problem symptom table (See page DI-494).

NG

- 2 Check harness and connector between cruise control ECU and DLC3, DLC3 and body ground (See page IN-30).**

NG

Repair or replace harness or connector.

OK

Check and replace cruise control ECU (See page IN-30).

Actuator Control Cable

INSPECTION PROCEDURE

1	Actuator control cable inspection
---	-----------------------------------

OK:

- (a) Check that the actuator and control cable throttle link are properly installed and that the cable and link are connected correctly.
- (b) Check that the actuator and bell crank operate smoothly.
- (c) Check that the cable is not loose or too tight.

OK:

Freeplay: less than 10 mm

HINT:

- If the control cable is very loose, the vehicle's loss of speed going uphill will be large.
- If the control cable is too tight, the idle RPM will become high.

BODY CONTROL SYSTEM

HOW TO PROCEED WITH TROUBLESHOOTING

DIAG-02

HINT:

This ECU is connected to the multiplex communication system. Therefore, be sure to check that there is no troubles in the multiplex communication system before performing the trouble shooting.

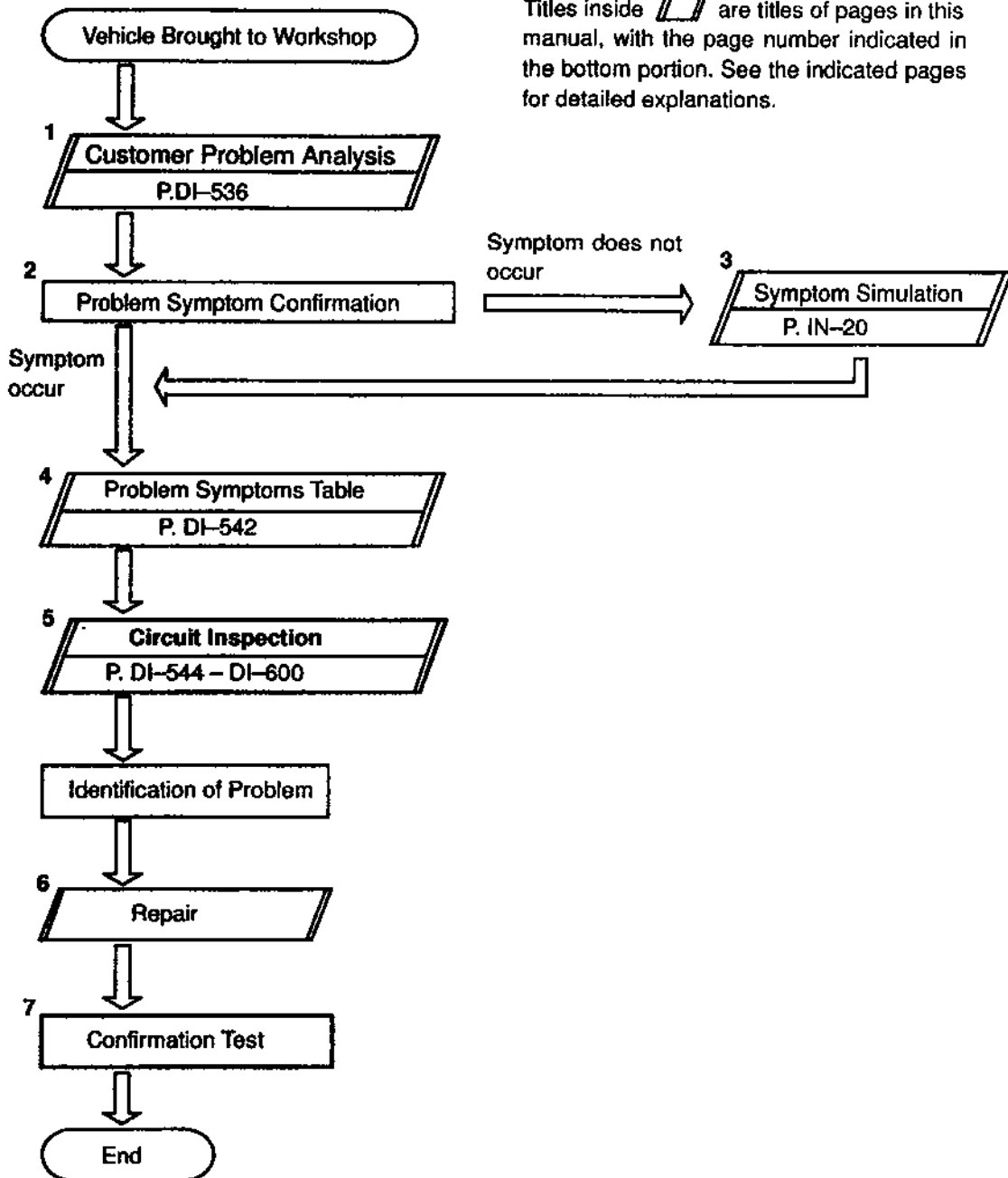

Step 6, 8 : Diagnostic steps permitting the use of the hand-held tester .

CUSTOMER PROBLEM ANALYSIS CHECK

BODY CONTROL SYSTEM Check Sheet

Inspector's name: _____

Customer's Name		Registration No.	
		Registration Year	
		Frame No.	
Date Vehicle Brought In	/ /	Odometer Reading	km Mile

Date Problem First Occurred	/ /
Frequency Problem Occurs	<input type="checkbox"/> Constant <input type="checkbox"/> Sometimes (times per day, month) <input type="checkbox"/> Once only
Weather Conditions When Problem Occurred	Weather <input type="checkbox"/> Fine <input type="checkbox"/> Cloudy <input type="checkbox"/> Rainy <input type="checkbox"/> Snowy <input type="checkbox"/> Various/ Others
	Outdoor Temperature <input type="checkbox"/> Hot <input type="checkbox"/> Warm <input type="checkbox"/> Cool <input type="checkbox"/> Cold (Approx. °F (°C))

Malfunction System	<input type="checkbox"/> Key Reminder System
	<input type="checkbox"/> Light Control System
	<input type="checkbox"/> Daytime Running Light System
	<input type="checkbox"/> Combination Meter (Open door warning light)
	<input type="checkbox"/> Light Auto Turn Off System
	<input type="checkbox"/> Illuminated Entry System
	<input type="checkbox"/> Seat Belt Warning
	<input type="checkbox"/> Power Window Control System
	<input type="checkbox"/> Power Door Lock Control System
	<input type="checkbox"/> Wireless Door Lock Control System
	<input type="checkbox"/> Others

PARTS LOCATION

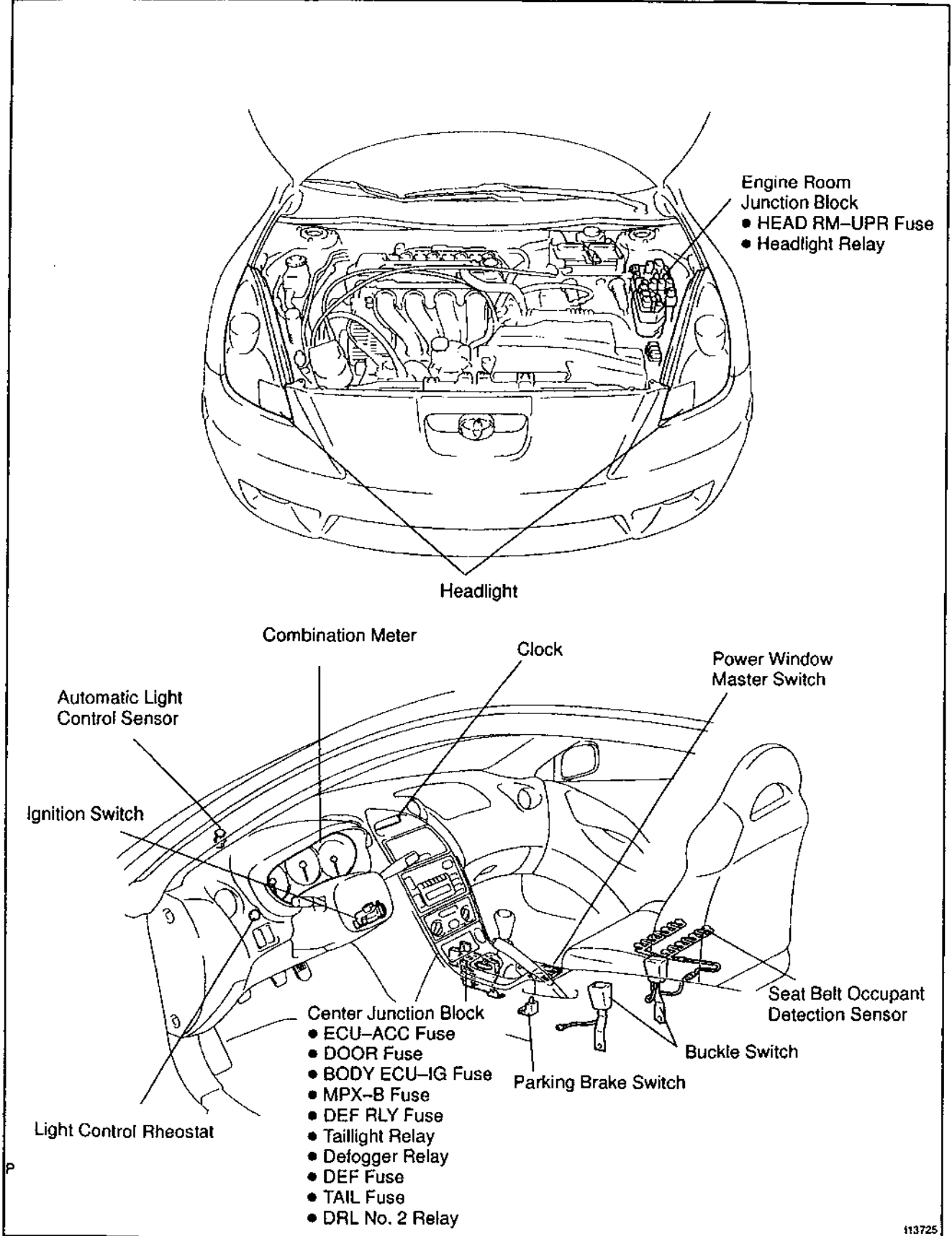

Front Personal Light

Room Light

Door Lock Assembly

- Door Lock Motor
- Door Unlock Detection Switch
- Door Key Lock and Unlock Switch

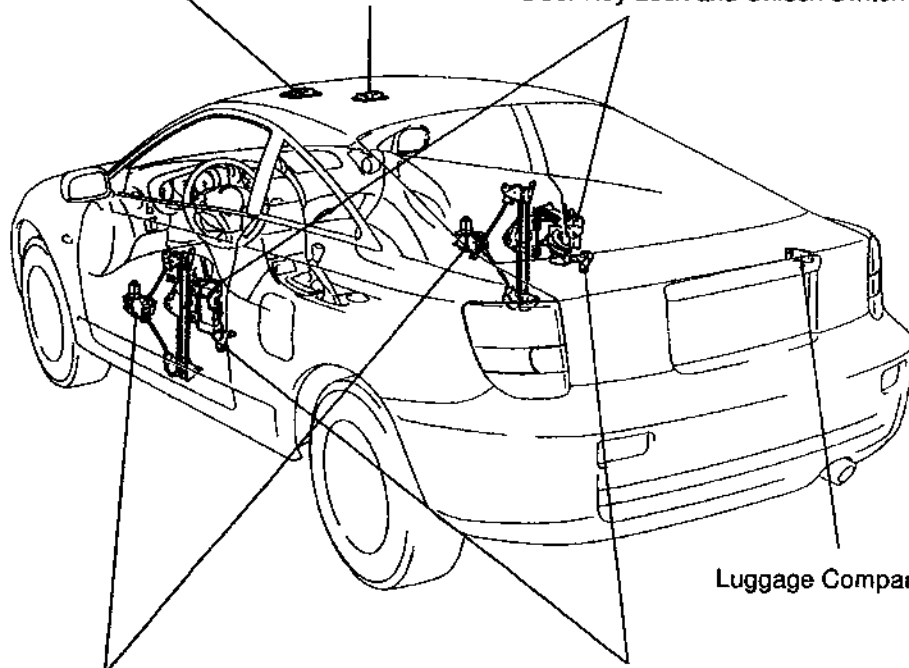

Power Window Regulator
• Power Window Motor

Door Courtesy Switch

Luggage Compartment Light

TERMINALS OF ECU

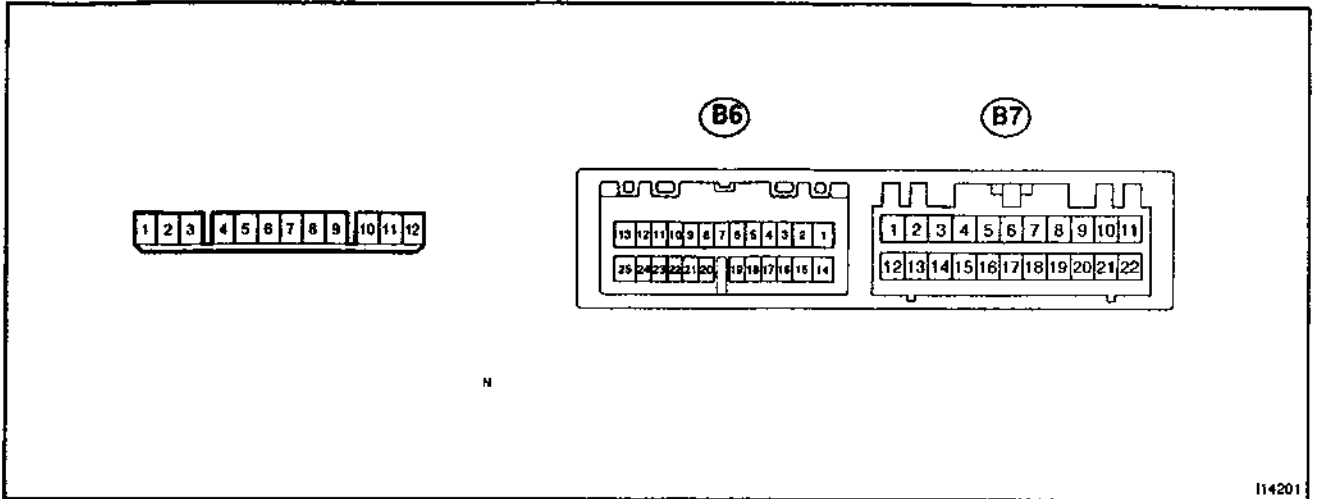

114201

Terminals No. (Symbols)	Wiring Color	Condition	STD Voltage (V)
1 - 11 (TRLY - E)	-	Light control switch OFF	10 - 14 V
		Light control switch TAIL or HEAD	Below 1 V
2 - 11 (DEFB - E)	-	Constant	10 - 14 V
3 - 11 (IG - E)	-	Ignition switch OFF or ACC	Below 1 V
		Ignition switch ON	10 - 14 V
4 - 11 (DEF - E)	-	Defogger switch OFF	10 - 14 V
		Defogger switch ON	Below 1 V
5 - 11 (B - E)	-	Constant	10 - 14 V
6 - 11 (L2 - E)	-	Door key lock and unlock switch OFF	Approx. 5 V
		Door key lock and unlock switch ON	Below 1 V
7 - 9 (ACT- - ACT+)	-	Door lock operating	10 - 14 V
8 - 11 (B - E)	-	Constant	10 - 14 V
10 - 11 (HRLY - E)	-	Light control switch OFF or TAIL	10 - 14 V
		Light control switch HEAD	Below 1 V
11 - Body ground (E - Body ground)	-	Constant	Below 1 V
12 - 11 (ACC - E)	-	Ignition switch OFF	Below 1 V
		Ignition switch ACC or ON	10 - 14 V
B6-1 - 11 (PWS - E)	GR	Sliding roof ECU communication circuit	-
B6-2 - 11 (BLVL - E)	R	Parking brake switch ON (parking brake is used)	Below 1 V
		Parking brake switch OFF (parking brake is not used)	Approx. 5V
B6-3 - 11 (CLTS - E)	LG - B	Automatic light control sensor communication circuit	-
B6-4 - 11 (CLTB - E)	G - W	Automatic light control sensor communication circuit	-

Terminals No. (Symbols)	Wiring Color	Condition	STD Voltage (V)
B6-5-11 (T-E)	LG	Light control switch OFF	10-14 V
		Light control switch TAIL or HEAD	Below 1 V
B6-9-11 (KSW-E)	Y	Key is inserted	Below 1 V
		Key is not inserted	10-14 V
B6-10-11 (LP-E)	R-W	Each door are opened	Below 2 V
		All door are closed	10-14 V
B6-11-11 (SG1-E)	W-L	Key is inserted	Below 1 V
		Key is not inserted	10-14 V
B6-12-11 (HF-E)	P-B	Light control switch HIGH beam or FLASH	Below 1 V
		Light control switch OFF or LOW beam	Approx. 5.7 V
B6-13-9 (ACTD-ACT+)	L	Driver door is operating	10-14 V
B6-14-11 (HORN-E)	L-B	Horn sound	Below 1 V
		Horn does not sound	10-14 V
B6-16-11 (MPX1-E)	R-L	Multiplex communication circuit	-
B6-17-11 (L-E)	Y-G	Engine running	Below 1 V
B6-18-11 (H-E)	R-L	Light control switch OFF or TAIL	Approx. 5.7 V
		Light control switch HEAD	Below 1 V
B6-20-11 (LSWP-E)	G	Except driver's door is unlocked	Below 1 V
		Except driver's door is locked	Approx. 5.7 V
B6-21-11 (LSWD-E)	B	Driver door is unlocked	Below 1 V
		Driver door is locked	Approx. 5.7 V
B6-22-11 (UL2-E)	L-W	Passenger door key lock and unlock switch OFF	Approx. 5.0 V
		Passenger door key lock and unlock switch ON	Below 1 V
B6-24-11 (CLTE-E)	LG-R	Automatic light control sensor communication circuit	-
B6-25-11 (UL3-E)	L-W	Driver door key lock and unlock switch OFF	Approx. 5.0 V
		Driver door key lock and unlock switch ON	Below 1 V
B7-1-11 (SG2-E)	W-L	Constant	Below 1 V
B7-2-11 (SG3-E)	W	Constant	Below 1 V
B7-3-11 (FU-E)	BR-W	Constant	Below 1 V
B7-7-11 (DBKL-E)	L	Driver seat belt buckle switch ON (belt fastened)	Below 1 V
		Driver seat belt buckle switch OFF (belt unfastened)	10-14 V
B7-18-11 (BLTW-E)	P	Driver seat belt buckle switch ON (belt fastened)	Below 1 V
		Driver seat belt buckle switch OFF (belt unfastened)	10-14 V
B7-9-11 (PRG-E)	R-B	Wireless door lock control receiver communication circuit	-
B7-10-11 (RDA-E)	Y	Wireless door lock control receiver communication circuit	-
B7-11-11 (PW-E)	Y-B	Key-off power window operation	10-14 V

DIAGNOSTICS - BODY CONTROL SYSTEM

Terminals No. (Symbols)	Wiring Color	Condition	STD Voltage (V)
B7-12-11 (FUA-E)	Y-R	Ignition switch ON and fuel sender gauge float DOWN	Approx. 0.3 V
		Ignition switch ON and fuel sender gauge float UP	Approx. 4.6 V
B7-13-11 (FU+-E)	Y-G	Ignition switch ON	Approx. 5.0 V
B7-14-11 (PBKL-E)	L-Y	Passenger seat belt buckle switch ON (belt fastened)	Below 1 V
		Passenger seat belt buckle switch OFF (belt unfastened)	Approx. 5.0 V
B7-15-11 (L1-E)	V-W	Door lock manual switch OFF or UNLOCK	Below 1 V
		Door lock manual switch LOCK	Approx. 5.0 V
B7-16-11 (UL1-E)	P-B	Door lock manual switch OFF or LOCK	Below 1 V
		Door lock manual switch UNLOCK	Approx. 5.0 V
B7-17-11 (DRL-E)	L-W	Daytime running light system operating when DRL ON	Below 1 V
B7-4-11 (SG4-E)	W-R	Sport mode switch OFF	10 - 14 V
		Sport mode switch ON	Below 1 V
B7-19-11 (PKB-E)	R-B	Parking brake is used	Below 1 V
		Parking brake is not used	10 - 14 V
B7-20-11 (DCTY-E)	R-Y	Driver door opened	Below 1 V
		Driver door closed	10 - 14 V
B7-21-11 (PCTY-E)	R	Passenger door opened	Below 1 V
		Passenger door closed	10 - 14 V
B7-22-11 (LGCY-E)	LG	Luggage door opened	Below 1 V
		Luggage door closed	10 - 14 V

PROBLEM SYMPTOMS TABLE**DOOR LOCK CONTROL**

Symptom	Suspect Area	See page
Lock or unlock cannot be operated with door lock control S/W.	1. Door lock control switch circuit (Master switch) 2. Body ECU	DI-571 IN-30
Door key linked function does not operate.	1. Door key lock and unlock switch circuit 2. Body ECU	DI-578 IN-30
Key confinement prevention function does not operate.	1. Key unlock switch circuit 2. Body ECU	DI-563 IN-30
Does not lock and unlock each door only.	1. Door lock motor circuit 2. Body ECU	DI-574 IN-30
Luggage compartment door opener function does not operate.	1. Luggage component door courtesy switch circuit 2. Body ECU	DI-582 IN-30

WIRELESS DOOR LOCK CONTROL

Symptom	Suspect Area	See page
All function of wireless door lock control system do not operate.	1. Transmitter 2. Wireless tuner circuit 3. Key unlock warning switch circuit 4. Body ECU	BE-73 DI-584 DI-563 IN-30
Lock (or unlock) function does not operate.	1. Door key lock and unlock switch circuit 2. Door unlock detection switch circuit 3. Body ECU	DI-578 DI-576 IN-30
Automatic lock function operates even if any door is opened within 30 seconds after all doors are unlocked by wireless door lock control system .	1. Door courtesy switch circuit 2. Body ECU	DI-580 IN-30

ILLUMINATED ENTRY

Symptom	Suspect Area	See page
Illuminated entry does not operate.	1. Illumination circuit 2. Body ECU	DI-560 IN-30

HEADLIGHT AND TAILLIGHT SYSTEM:

Symptom	Suspect Area	See page
Headlight does not light up.	1. Light control switch circuit 2. Headlight control relay circuit 3. Body ECU	DI-556 DI-550 IN-30
Taillight does not light up.	1. Light control switch circuit 2. Taillight control relay circuit 3. Body ECU	DI-556 DI-548 IN-30
Automatic light control system does not operate.	1. Automatic light control sensor circuit 2. Light control switch circuit 3. Body ECU	DI-598 DI-556 IN-30
Auto turn-off system does not operate.	1. Driver door courtesy switch circuit 2. Body ECU	DI-580 IN-30

OTHERS

Symptom	Suspect Area	See page
Does not turn off the driver seat belt warning light	1. Driver buckle switch circuit 2. Body ECU	DI-565 IN-30
Does not turn off the passenger seat belt warning light.	1. Passenger buckle switch circuit 2. Body ECU	DI-565 IN-30
Rear window defogger does not operate.	1. Defogger relay circuit 2. Defogger switch 3. Body ECU	DI-588 BE-55 IN-30
Body ECU does not operate.	1. Power source circuit 2. Body ECU	DI-544 IN-30
Fuel sender gauge does not operate.	1. Fuel sender gauge circuit 2. Combination meter system 3. Body ECU	DI-588 BE-46 IN-30

CIRCUIT INSPECTION

Power Source Circuit

CIRCUIT DESCRIPTION

This circuit provides power to operate the Body ECU.

WIRING DIAGRAM

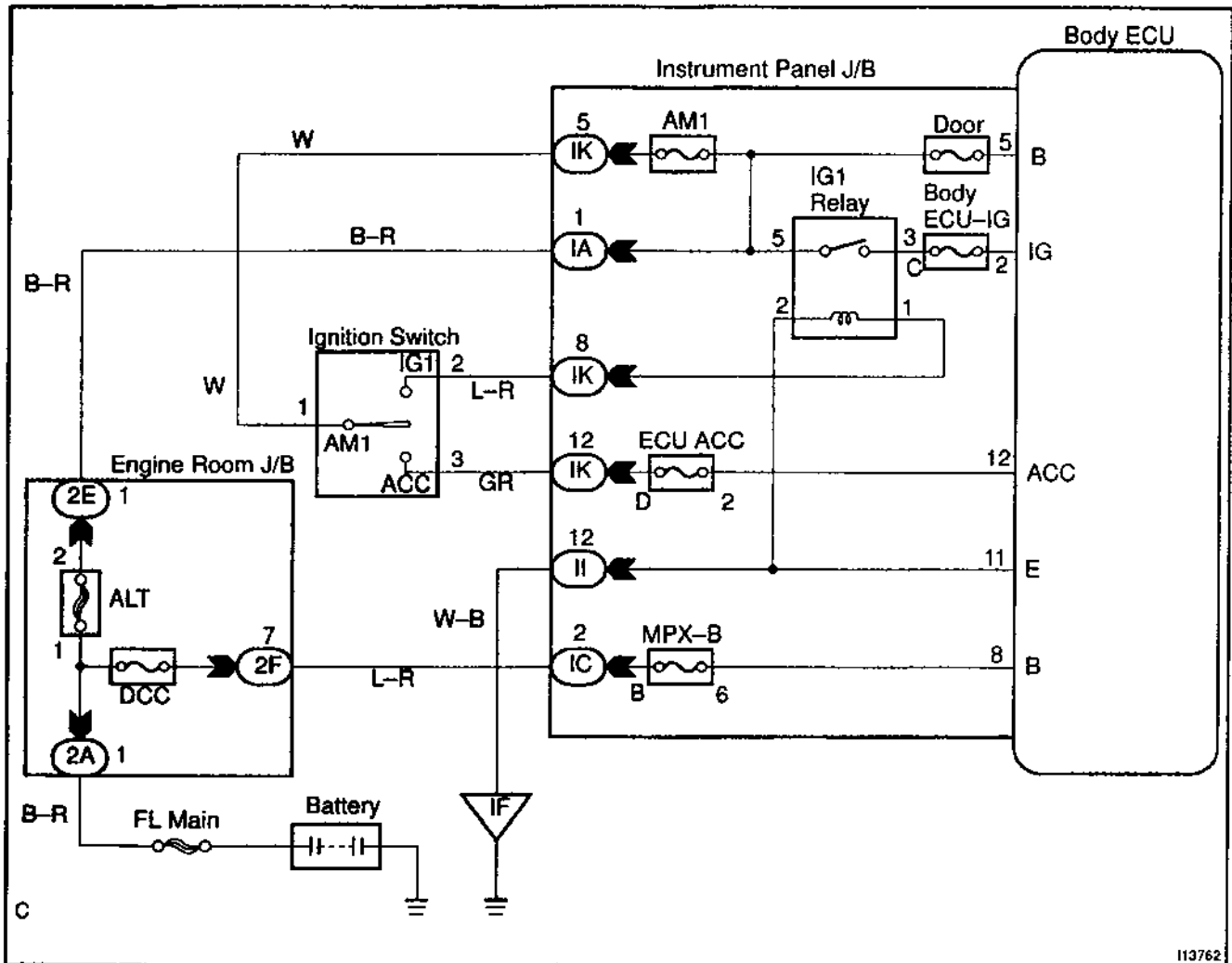

INSPECTION PROCEDURE

1	Check MPX-B, DCC, AM1 and DOOR fuse.
----------	---------------------------------------------

CHECK:

Check continuity of MPX-B, DCC, AM1 and DOOR fuse.

OK:

Continuity

NG	Replace the failure fuse.
-----------	----------------------------------

OK

2	Check voltage between terminals B, B and E of Body ECU connector.
----------	--------------------------------------------------------------------------

PREPARATION:

- (a) Turn ignition switch OFF.
- (b) Disconnect the Body ECU connector.

CHECK:

Measure voltage between terminals B, B and E.

OK:

Voltage: 10 - 14V

OK	Proceed to next circuit inspection shown on problem symptoms table (See page DI-542).
-----------	----------------------------------------------------------------------------------------------

NG

3	Check wireharness and connector between Body ECU and body ground (See page IN-30).
----------	-------------------------------------------------------------------------------------------

NG	Repair or replace wireharness or connector.
-----------	----------------------------------------------------

OK

Check and repair wireharness and connector between Body ECU and battery.

Ignition Switch Power Source Circuit

CIRCUIT DESCRIPTION

When the ignition switch is turned to the ACC position, battery voltage is applied to the terminal ACC of the ECU and when the ignition switch is turned to the ON position, battery voltage is applied to the terminal IG of the ECU.

WIRING DIAGRAM

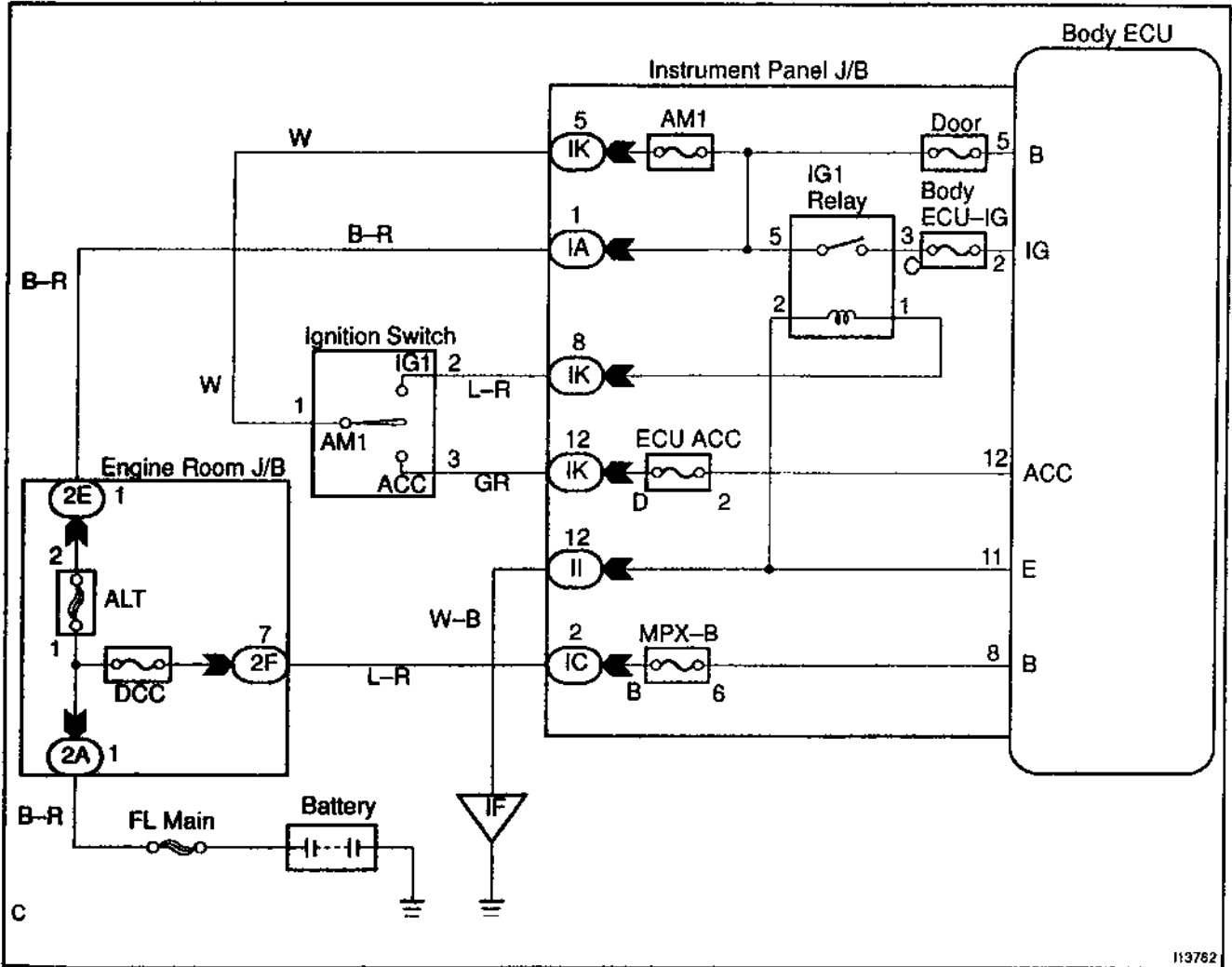

INSPECTION PROCEDURE**1 Check BODY ECU-IG and ECU-ACC fuse.****CHECK:**

Check continuity of BODY ECU-IG and ECU-ACC fuse.

OK:

Continuity

NG

Replace the failure fuse.

OK

2 Check voltage between terminals ACC, IG and GND of Body ECU connector.**PREPARATION:**

Turn ignition switch ON.

CHECK:

Measure voltage between terminals ACC, IG, and GND.

OK:

Voltage: 10 - 14V

OK

Proceed to next circuit inspection shown on problem symptoms table (See page DI-542).

NG

3 Check wireharness and connector between Body ECU and body ground (See page IN-30).

NG

Repair or replace wireharness or connector.

OK

Check and repair wireharness and connector between Body ECU and battery.

INSPECTION PROCEDURE

1	Check taillight relay (See page BE-17).
----------	------------------------------------------------

NG

Replace the taillight relay.

OK

2	Check wireharness and connector between taillight relay and Body ECU, battery and taillight relay (See page IN-30).
----------	----------------------------------------------------------------------------------------------------------------------------

NG

Repair or replace wireharness or connector.

OK

Proceed to next circuit inspection shown on problem symptoms table (See page DI-542).

Headlight Relay Circuit

CIRCUIT DESCRIPTION

Head light relay will be "ON" by operating the headlight switch. The transistor which activates the headlight relay has two sorts: one activates directly by the headlight switch for fail safe and the other activates by CPU. the one that activates by CPU has two systems and prevents the headlight from turning off at the time of one system trouble in the automatic operation circuit.

WIRING DIAGRAM

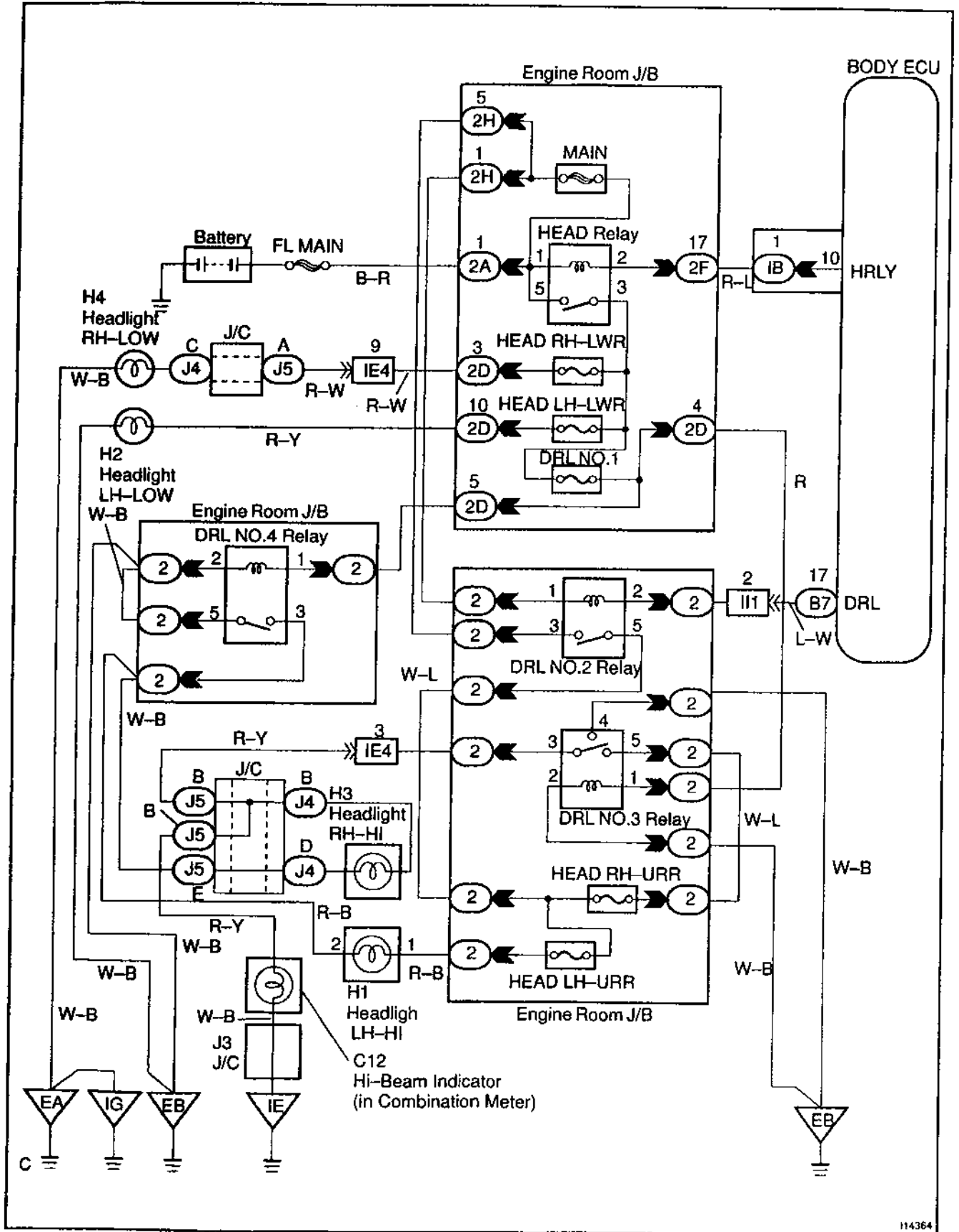

INSPECTION PROCEDURE

1 Check headlight relay (See page BE-17).

NG

Replace the headlight relay.

OK

2 Check wireharness and connector between headlight relay and Body ECU, battery and headlight relay (See page IN-30).

NG

Repair or replace wireharness or connector.

OK

Proceed to next circuit inspection shown on problem symptoms table (See page DI-542).

Daytime Running Light No. 2 Relay Circuit

CIRCUIT DESCRIPTION

When the light control switch is set to OFF or TAIL after the following conditions are satisfied simultaneously with the ignition switch ON, the daytime running lights up by control of the body ECU.

- The parking brake switch is OFF.
- The generator is ON (Engine running)

WIRING DIAGRAM

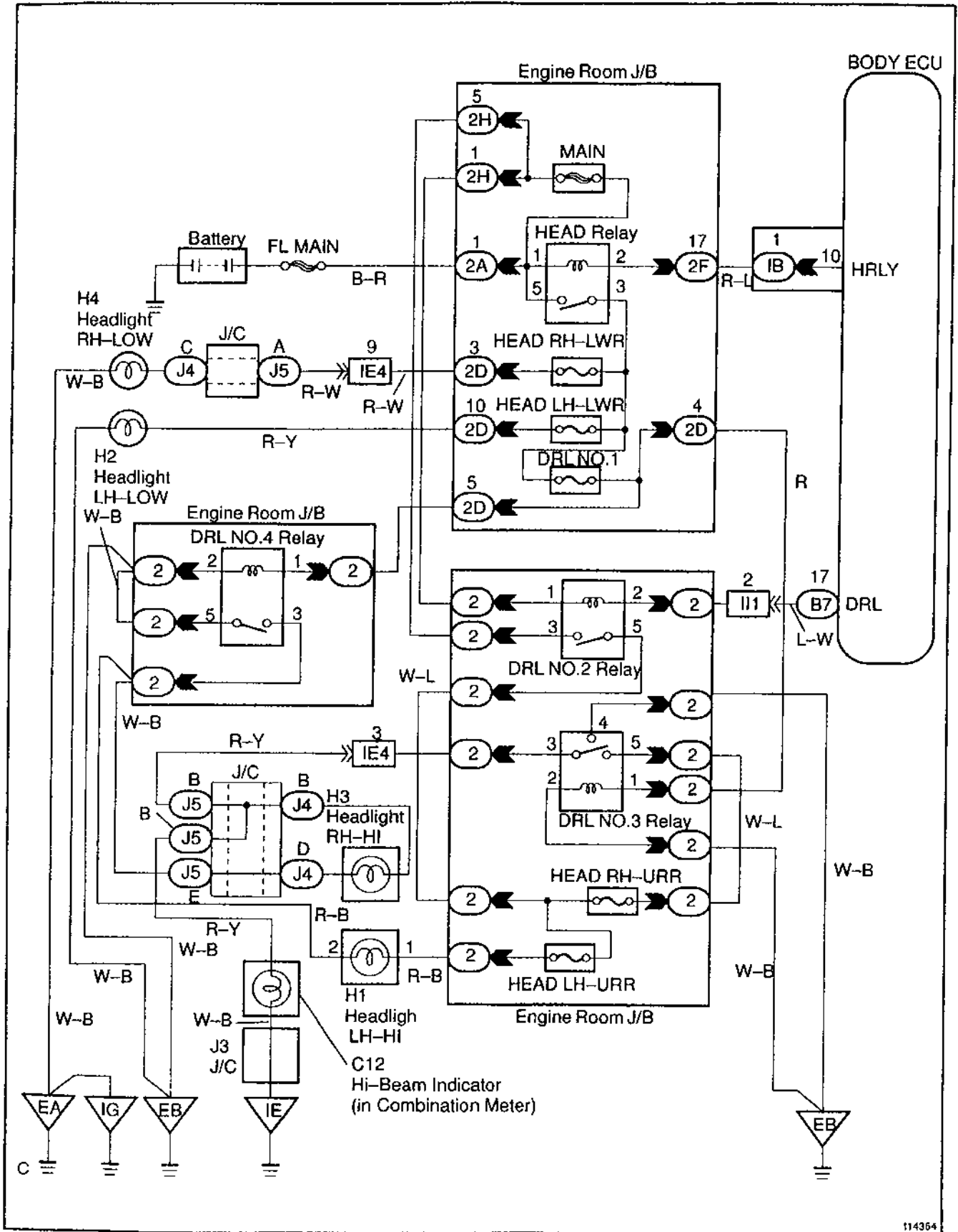

INSPECTION PROCEDURE**1****Check D.R.L. No. 2 relay (See page BE-17).****NG****Replace the D.R.L. No. 2 relay.****OK****2****Check wireharness and connector between D.R.L. No. 2 relay and Body ECU, battery and D.R.L. No. 2 relay (See page IN-30).****NG****Repair or replace wireharness or connector.****OK****Proceed to next circuit inspection shown on problem symptoms table (See page DI-542).**

Light Control Switch Circuit

CIRCUIT DESCRIPTION

This circuit defects the state of the light control switch.

WIRING DIAGRAM

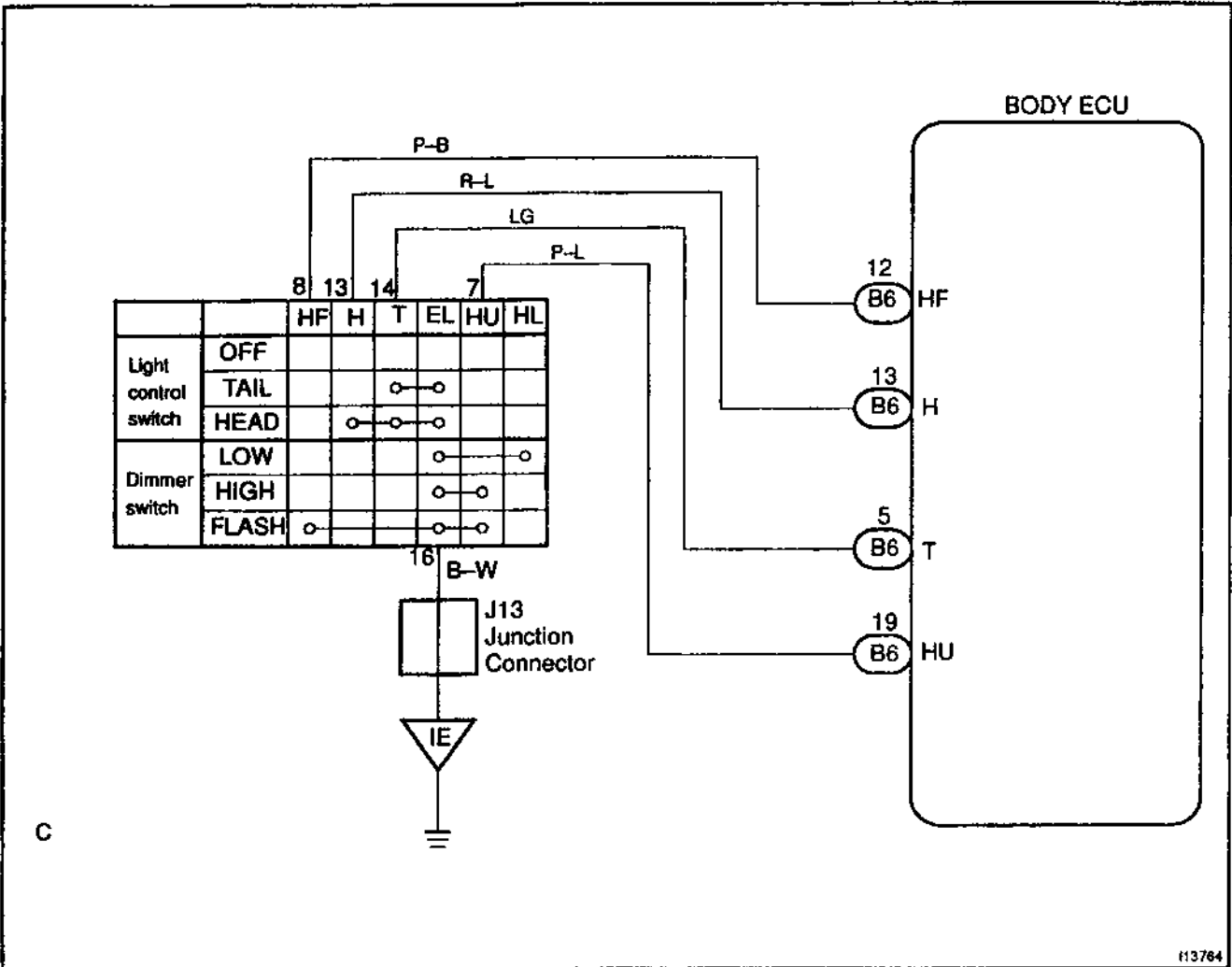

INSPECTION PROCEDURE

1 Check light control switch (See page BE-17).

NG

Replace the headlight control switch.

OK

2 Check wireharness and connector between headlight control switch and Body ECU (See page IN-30).

NG

Repair or replace wireharness or connector.

OK

Proceed to next circuit inspection shown on problem symptoms table (See page DI-542).

Headlight Dimmer Switch Circuit

CIRCUIT DESCRIPTION

This circuit detects the state of the headlight dimmer switch.

WIRING DIAGRAM

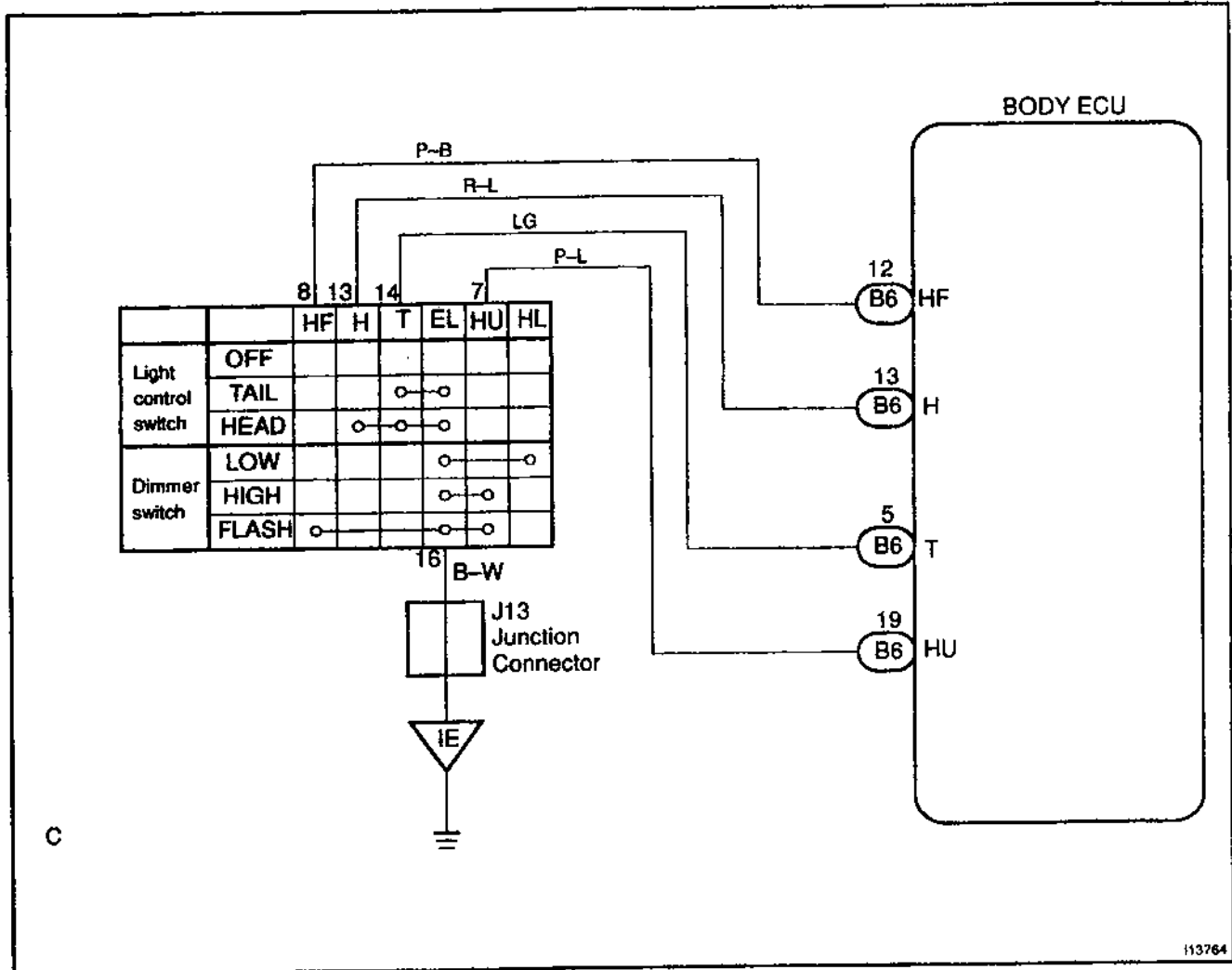

INSPECTION PROCEDURE

1 Check headlight dimmer switch (See page BE-17).

NG

Replace the headlight dimmer switch.

OK

2 Check wireharness and connector between headlight dimmer switch and Body ECU (See page IN-30).

NG

Repair or replace wireharness or connector.

OK

Proceed to next circuit inspection shown on problem symptoms table (See page DI-542).

Illumination Circuit

CIRCUIT DESCRIPTION

Receiving the courtesy signal from the Body ECU will make the interior light, ignition light, and courtesy light come on.

WIRING DIAGRAM

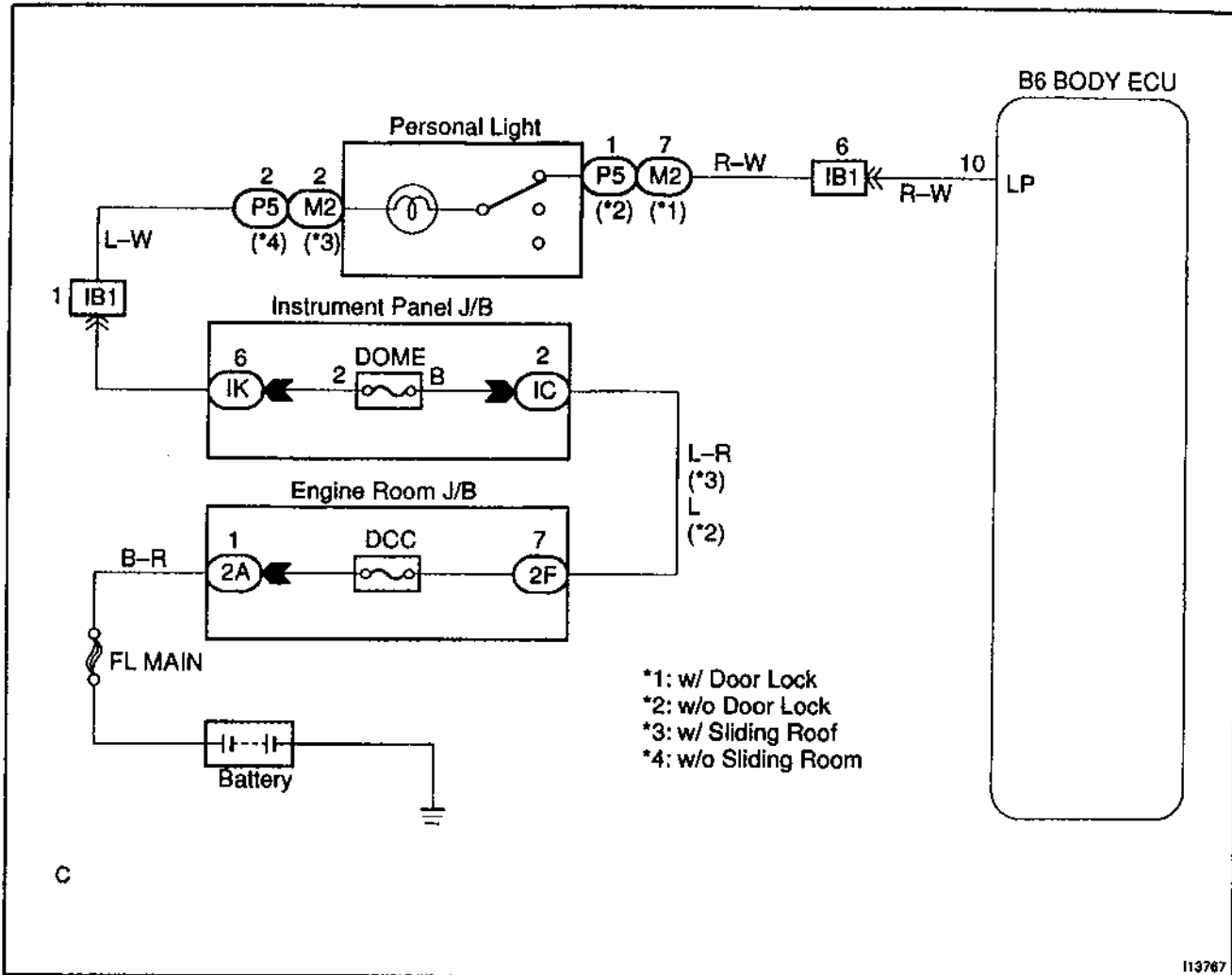

INSPECTION PROCEDURE

1	Check DOME fuse.
----------	-------------------------

NG	Replace the fuse.
-----------	--------------------------

OK

2	Check illumination light.
----------	----------------------------------

NG	Replace the failure light.
-----------	-----------------------------------

OK

3	Check wireharness and connector between each illumination light and Body ECU, battery and each illumination light (See page IN-30).
----------	--------------------------------------------------------------------------------------------------------------------------------------------

NG	Repair or replace wireharness or connector.
-----------	----------------------------------------------------

OK

Proceed to next circuit inspection shown on problem symptoms table (See page DI-542).

INSPECTION PROCEDURE

1	Check key unlock warning switch (See page BE-14).
----------	----------------------------------------------------------

NG

Replace the key unlock warning switch.

OK

2	Check wireharness and connector between key unlock warning switch and Body ECU (See page IN-30).
----------	---------------------------------------------------------------------------------------------------------

NG

Repair or replace wireharness or connector.

OK

Proceed to next circuit inspection shown on problem symptoms table (See page DI-542).

Key Unlock Warning Switch Circuit

CIRCUIT DESCRIPTION

The key unlock warning switch goes on when the ignition key is inserted in the key cylinder and goes off when the ignition key is removed.

The ECU operates the key confinement prevention function while the key unlock warning switch is on.

WIRING DIAGRAM

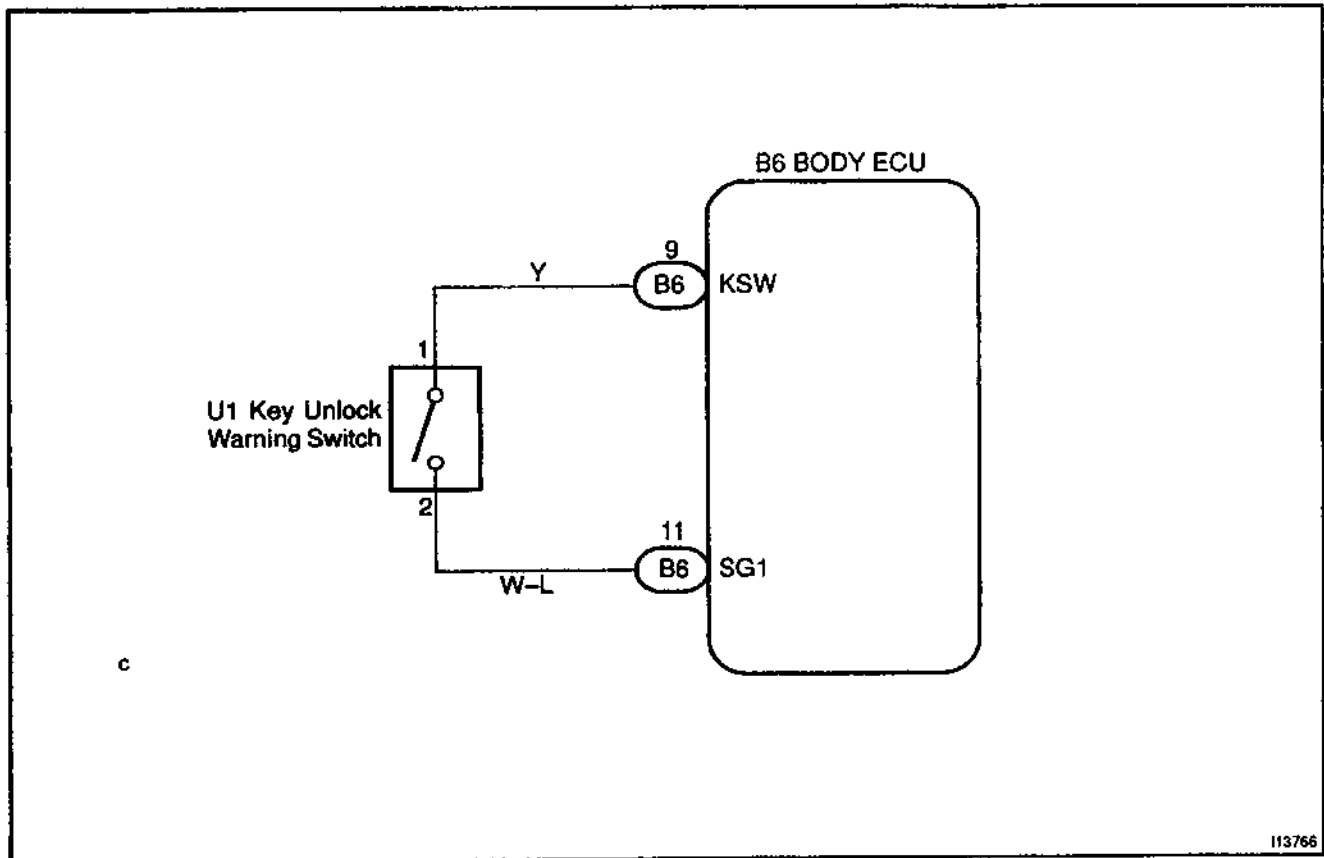

Driver Buckle Switch Circuit

CIRCUIT DESCRIPTION

When the buckle switch of the driver's seat is ON with the ignition switch ON, the body ECU sends a signal to make the seat belt warning light for the driver's seat light up and to sound a buzzer. When the buckle switch of the passenger seat is ON and the passenger seat belt occupant detecting sensor is ON with the ignition switch ON, the body ECU sends a signal to make the seat belt warning light for the passenger seat light up.

WIRING DIAGRAM

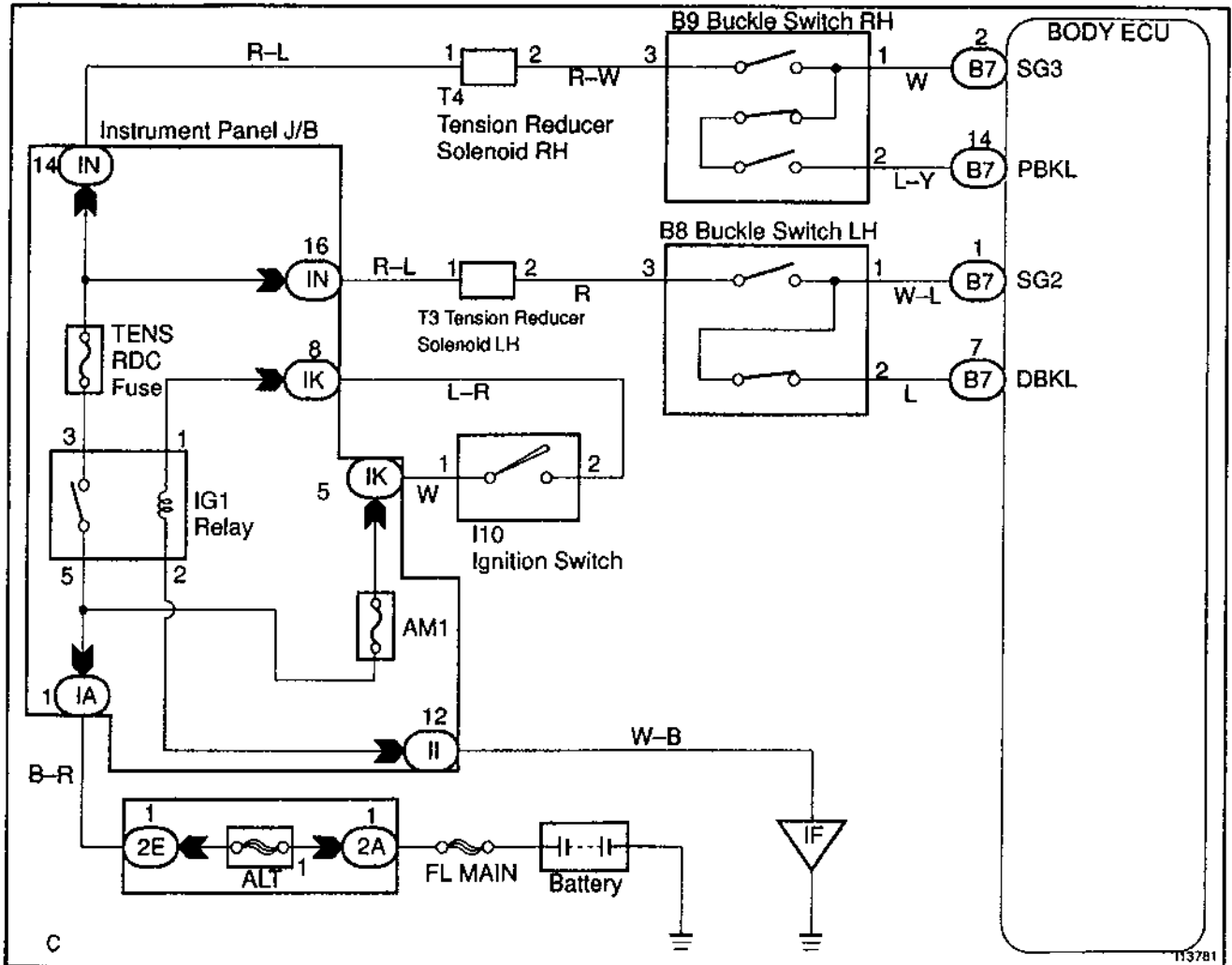

INSPECTION PROCEDURE

1 Check buckle switch (See page BE-46).

NG

Replace the buckle switch.

OK

2 Check wire harness and connector between buckle switch and body ground (See page IN-30).

NG

Repair or replace wire harness or connector.

OK

Proceed to next circuit inspection shown on problem symptoms table (See page DI-542).

Horn Circuit

CIRCUIT DESCRIPTION

The horn is connected to the body ECU and activated by the body ECU.

WIRING DIAGRAM

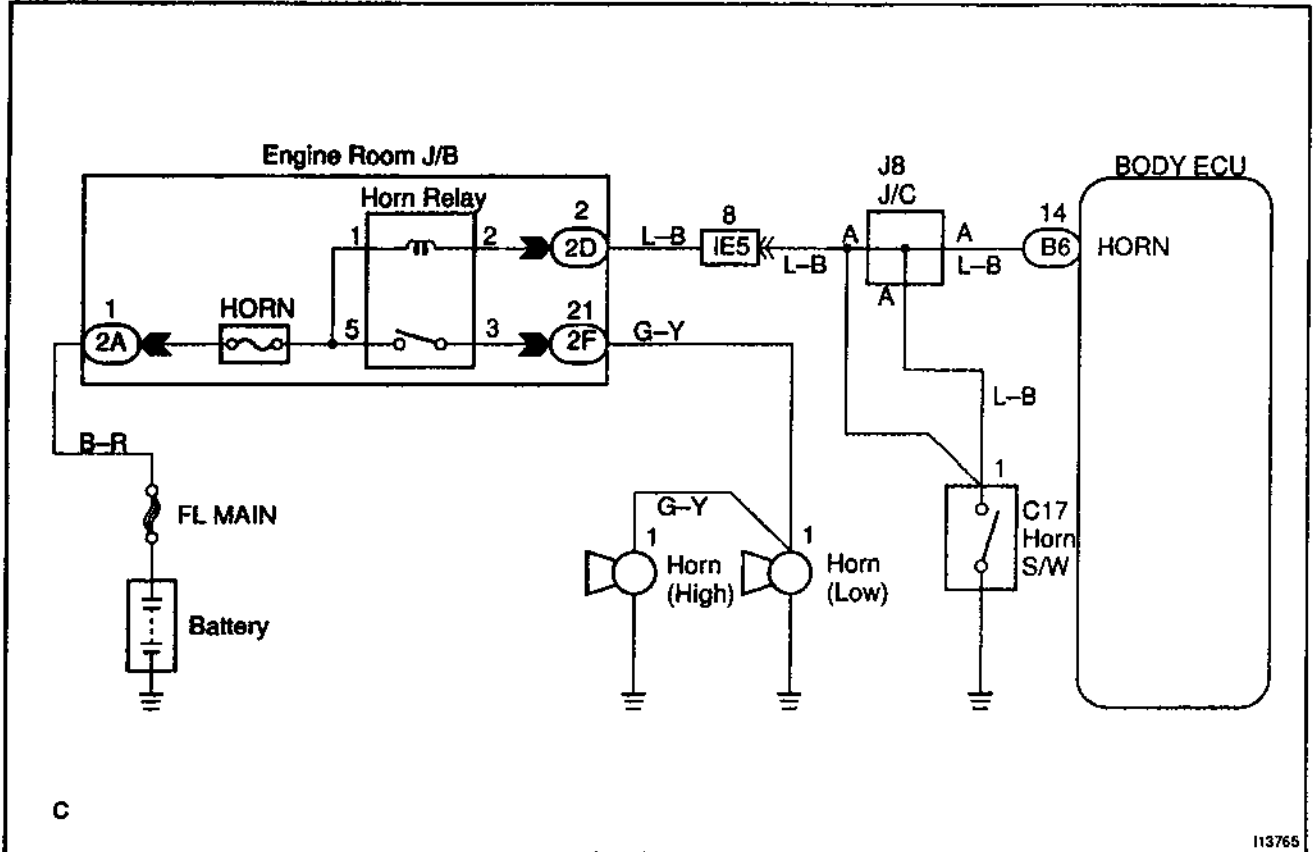

C

INSPECTION PROCEDURE

1 Check horn (See page BE-126).

NG

Replace the horn.

OK

2 Check wireharness and connector between horn relay and body ECU, battery and horn relay (See page IN-30).

NG

Repair or replace wireharness or connector.

OK

Proceed to next circuit inspection shown on problem symptoms table (See page DI-542).

PWS Circuit

CIRCUIT DESCRIPTION

When the ignition switch is ON, or during the time from when the ignition switch is turned OFF till 43 sec. has elapsed or till the closed door is opened, the body ECU permits the operation of the power window and sliding roof.

WIRING DIAGRAM

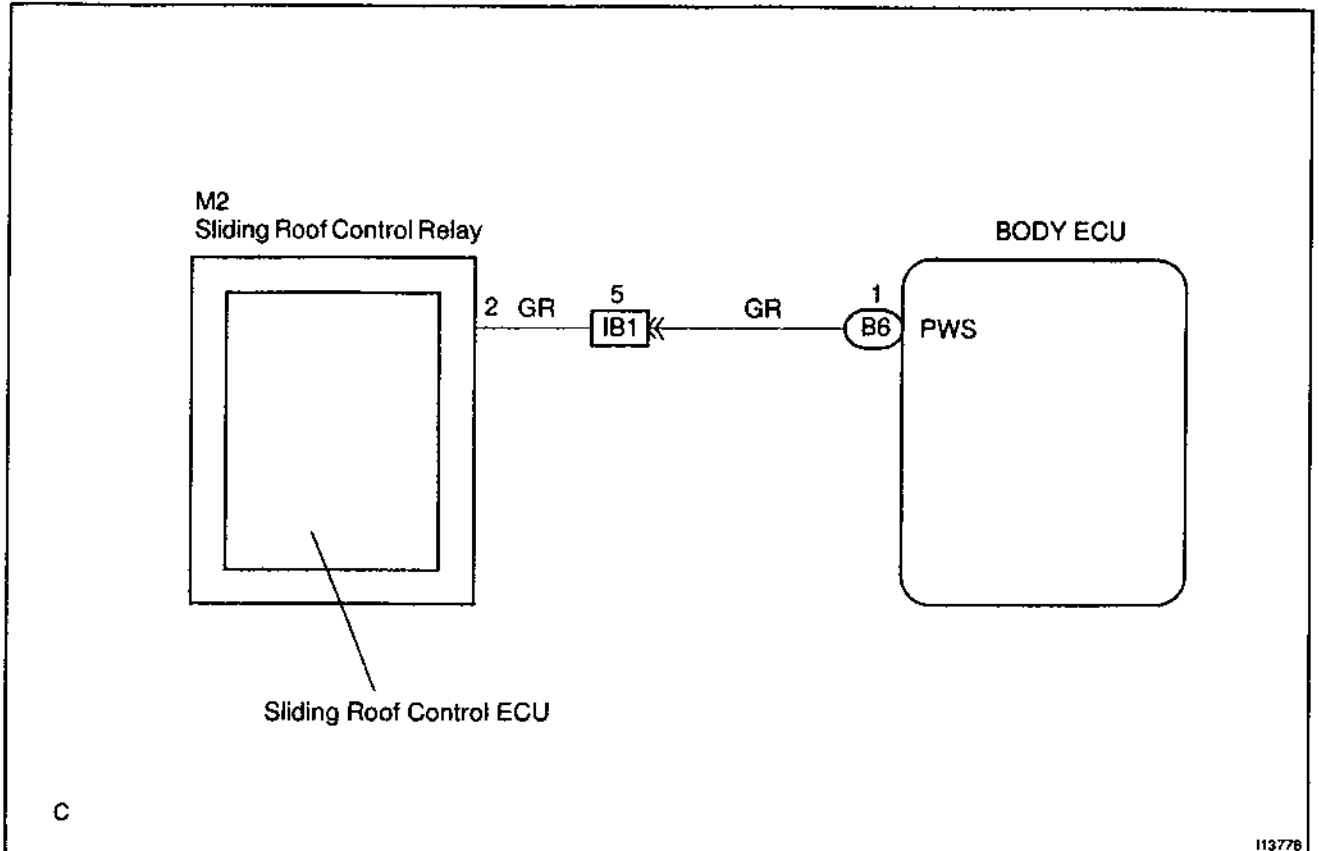

INSPECTION PROCEDURE

1	Check wireharness and connector between sliding roof control assembly and Body ECU (See page IN-30).
---	-------------------------------------------------------------------------------------------------------------

NG**Repair or replace wireharness or connector.****OK**

Proceed to next circuit inspection shown on problem symptoms table (See page DI-542).

Power Window Master Switch Circuit

CIRCUIT DESCRIPTION

This circuit detects the state of the power window master switch.

WIRING DIAGRAM

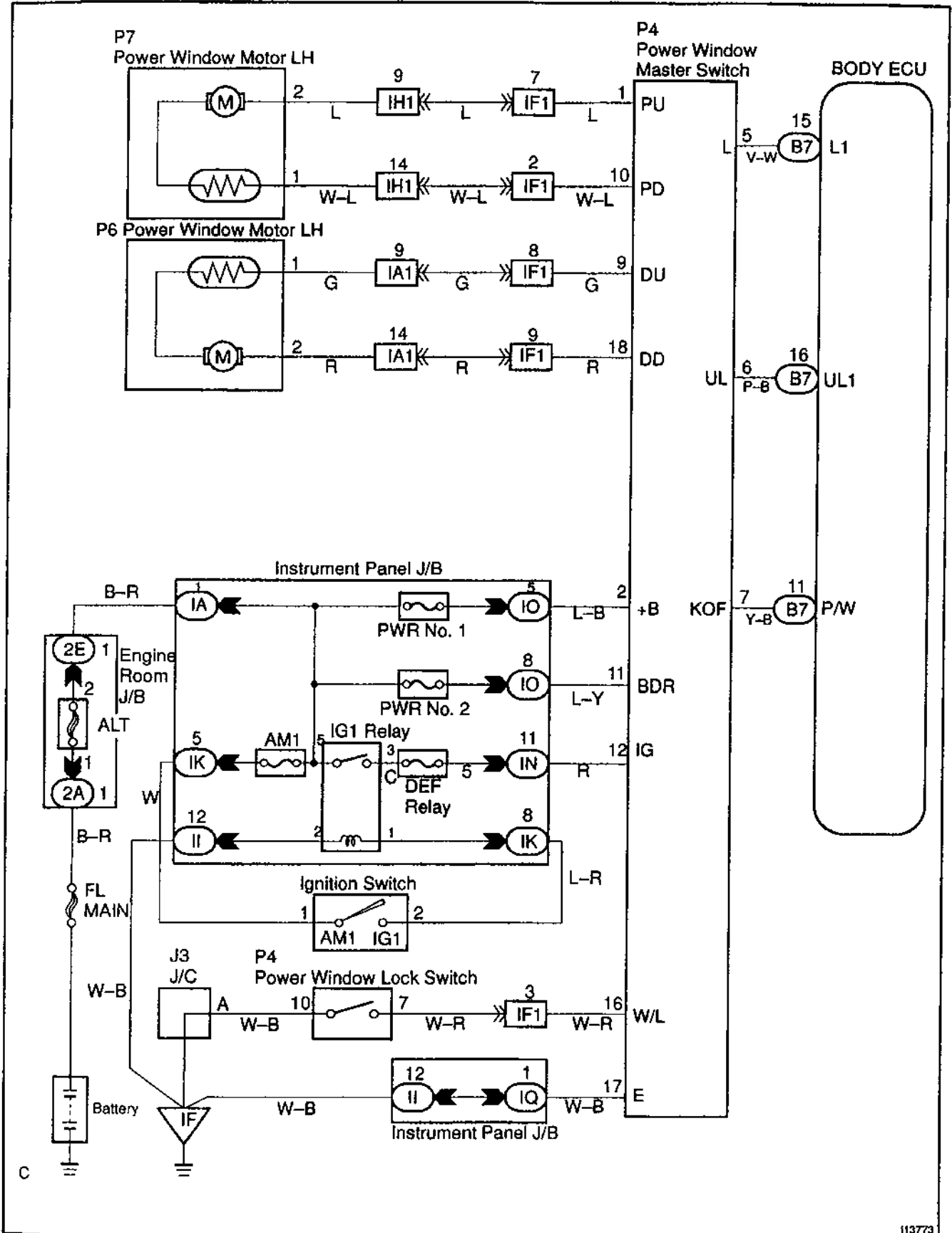

INSPECTION PROCEDURE

1 Check the power window master switch (See page BE-59).

NG

Replace the power window master switch.

OK

2 Check wireharness and connector between power window master switch and body ECU (See page IN-30).

NG

Repair or replace wireharness or connector.

OK

Proceed to next circuit inspection shown on problem symptoms table (See page DI-542).

Door Lock Motor Circuit

CIRCUIT DESCRIPTION

When the door switch is set to LOCK, the body ECU outputs a signal to lock all of the doors.

WIRING DIAGRAM

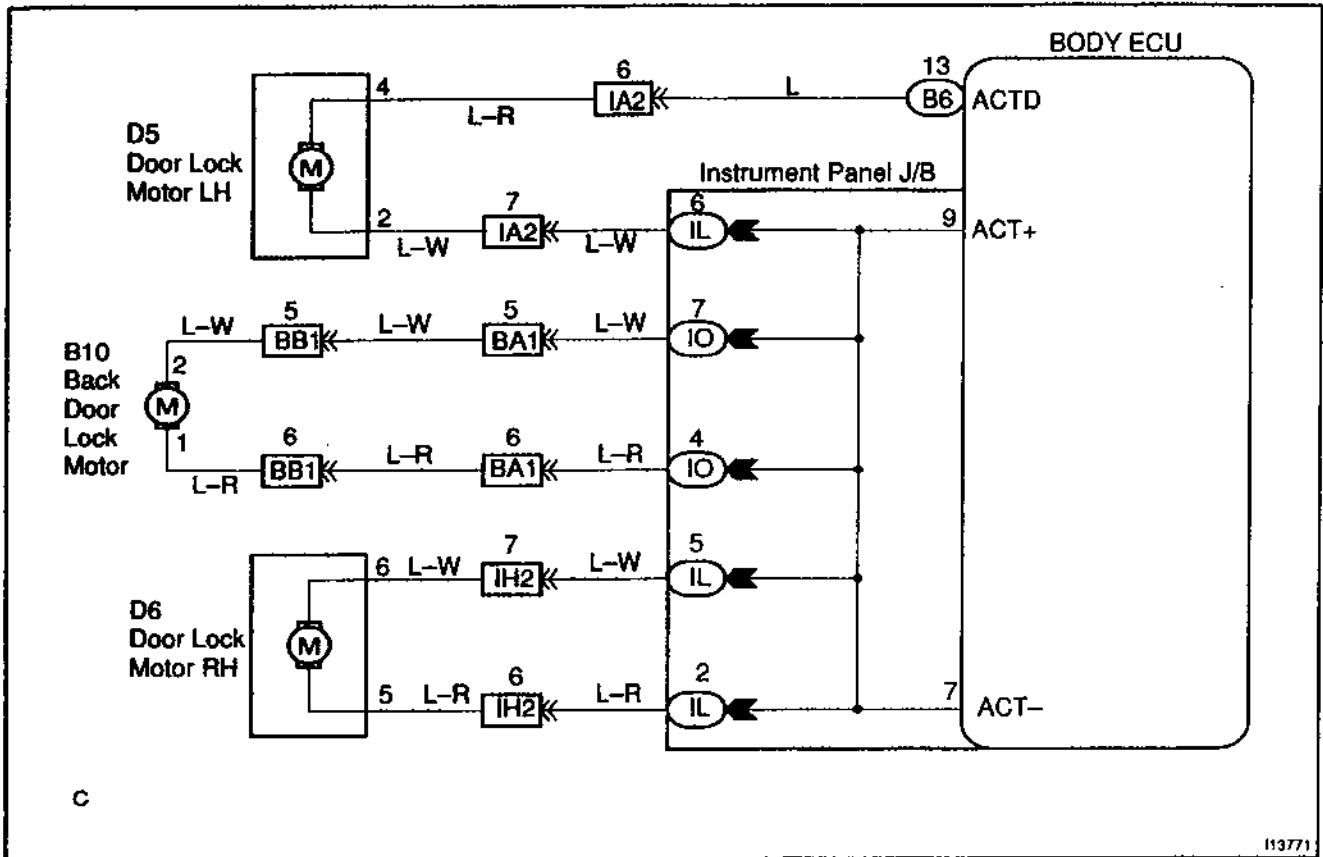

INSPECTION PROCEDURE

1 Check door lock motor (See page BE-63).

NG

Replace the door lock motor.

OK

2 Check wireharness and connector between door lock motor and body ECU (See page IN-30).

NG

Repair or replace wireharness or connector.

OK

Proceed to next circuit inspection shown on problem symptoms table (See page DI-542).

INSPECTION PROCEDURE

1 Check door unlock detection switch (See page BE-63).

NG

Replace the door unlock detection switch.

OK

2 Check wireharness and connector between door unlock detection switch and body ECU (See page IN-30).

NG

Repair or replace wireharness or connector.

OK

Proceed to next circuit inspection shown on problem symptoms table (See page DI-542).

Door Key Lock and Unlock Switch Circuit

CIRCUIT DESCRIPTION

The door key lock and unlock switch is built in the door key cylinder. When the key is turned to the lock side, terminal 3 of the switch is grounded and when the key is turned to the unlock side, terminal 2 of the switch is grounded.

WIRING DIAGRAM

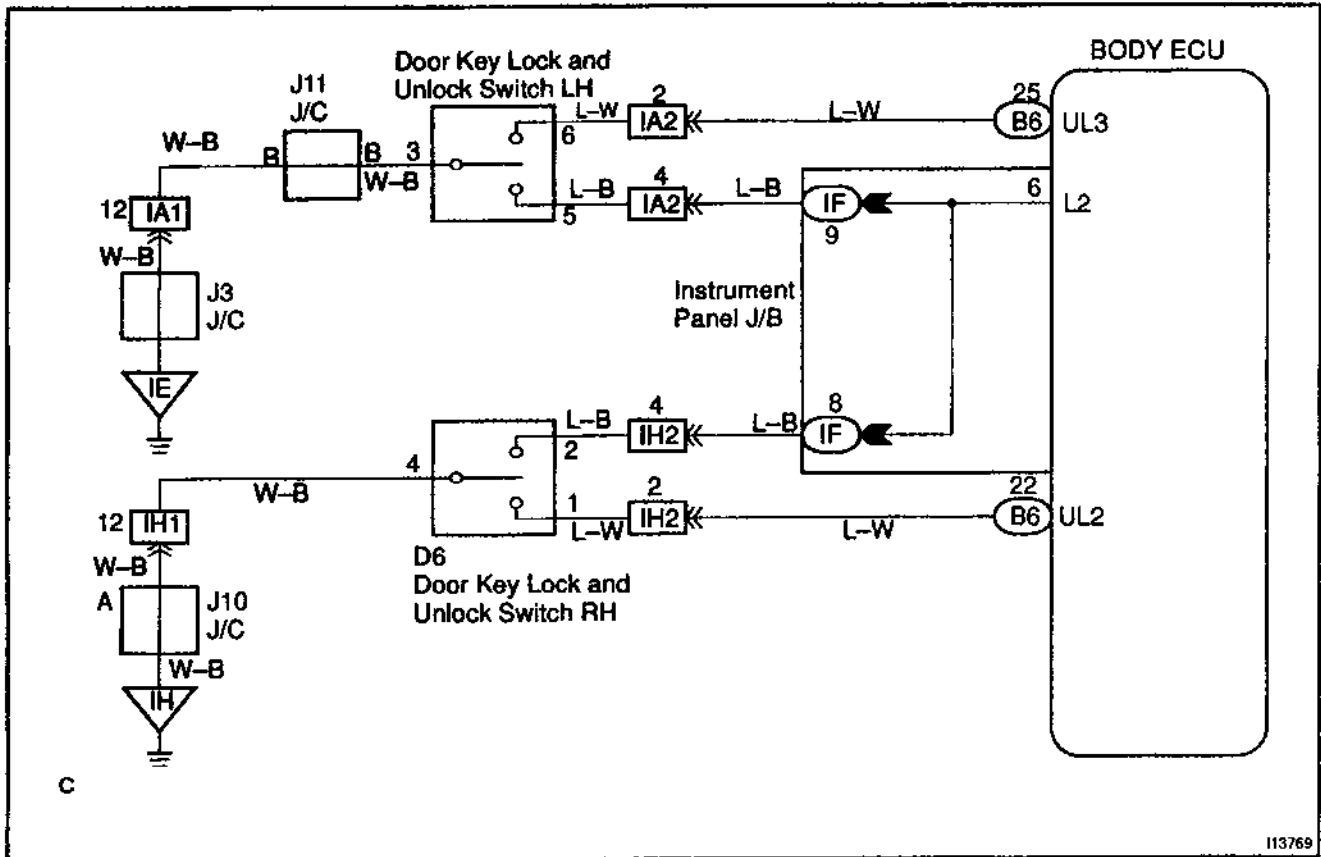

INSPECTION PROCEDURE

1 Check the door key lock and unlock switch (See page BE-63).

NG

Replace the door key lock and unlock switch.

NG

2 Check wireharness and connector between door key lock and unlock switch and body ECU (See page IN-30).

NG

Repair or replace wireharness or connector.

OK

Proceed to next circuit inspection shown on problem symptoms table (See page DI-542).

Door Courtesy Switch Circuit

CIRCUIT DESCRIPTION

The door courtesy switch goes on when the door is opened and goes off when door is closed.

WIRING DIAGRAM

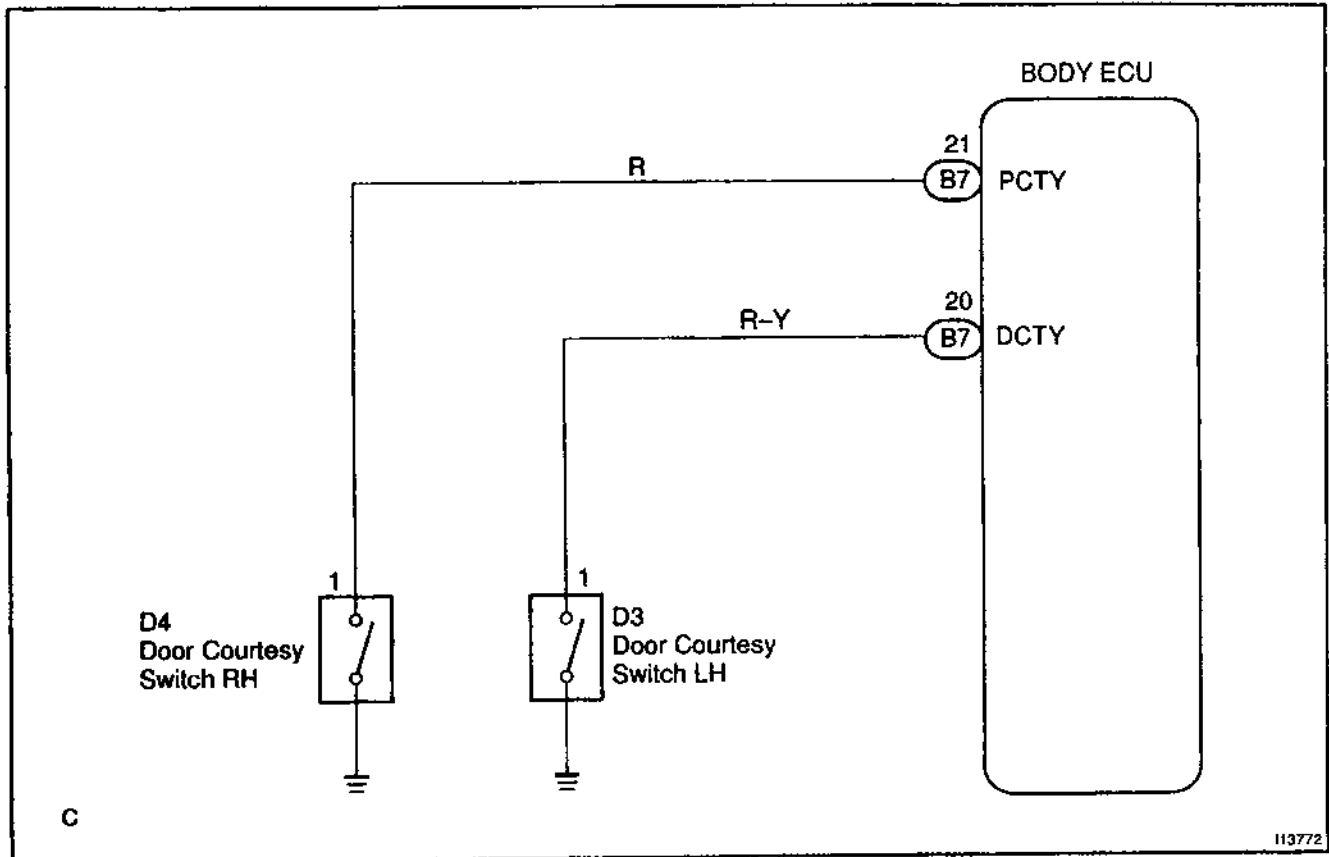

INSPECTION PROCEDURE

1 Check courtesy switch (See page BE-28).

NG

Replace the courtesy switch.

OK

2 Check that there is a grounding malfunction caused by looseness of the tighten screw.

NG

Install screw.

OK

3 Check wireharness and connector between courtesy light and body ECU, courtesy switch and body ECU (See page IN-30).

NG

Repair or replace wireharness or connector.

OK

Proceed to next circuit inspection shown on problem symptoms table (See page DI-542).

Luggage Courtesy Switch Circuit

CIRCUIT DESCRIPTION

The luggage courtesy switch goes on when luggage compartment door is opened and goes off when luggage compartment door is closed.

WIRING DIAGRAM

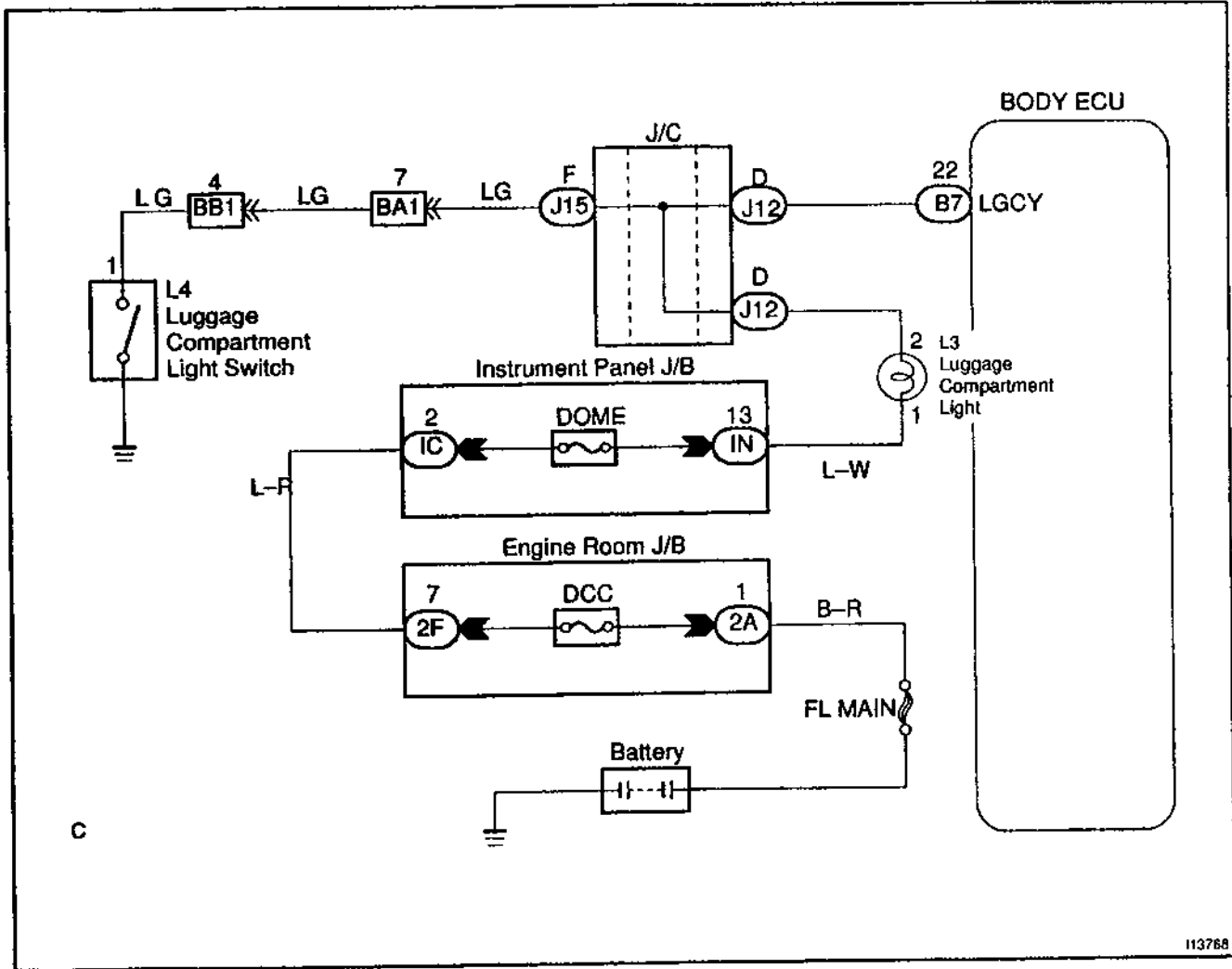

C

INSPECTION PROCEDURE

1	Check luggage courtesy switch (See page BE-28).
----------	--------------------------------------------------------

NG	Replace the luggage courtesy switch.
-----------	---------------------------------------------

OK

2	Check wire harness and connector between luggage courtesy switch and Body ECU (See page IN-30).
----------	--------------------------------------------------------------------------------------------------------

NG	Repair or replace wire harness or connector.
-----------	-----------------------------------------------------

OK

Proceed to next circuit inspection shown on problem symptoms table (See page DI-542).

Wireless Door Lock Tuner Circuit

CIRCUIT DESCRIPTION

The signal from the transmitter will be input to the body ECU through RDA line. RDA line is diagnosed by the Body ECU, so check DTC also in case of the failure of the wireless function.

WIRING DIAGRAM

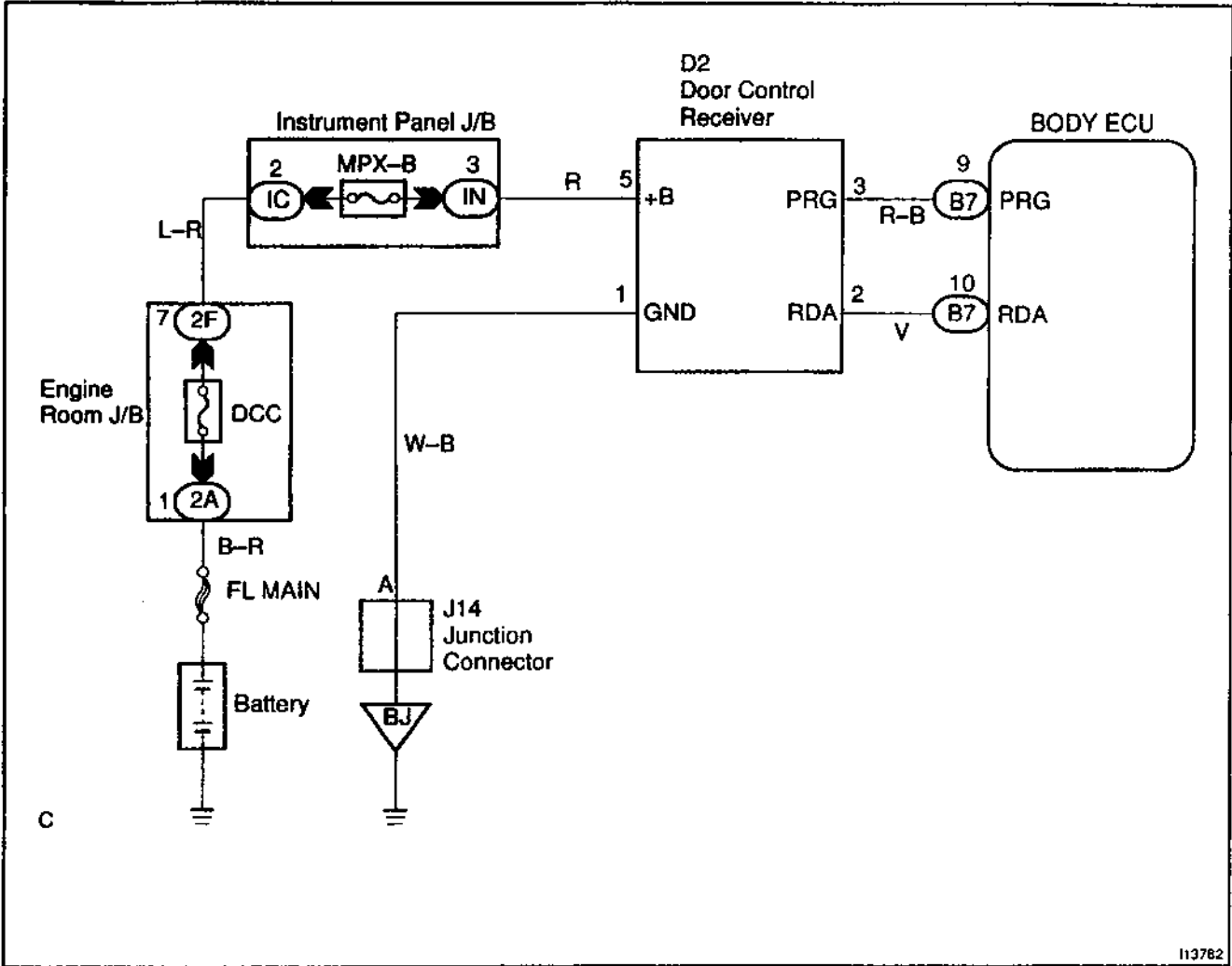

INSPECTION PROCEDURE

1	Check that DTC 42 is not output.
----------	-----------------------------------------

NG	Check the RDA line.
-----------	----------------------------

OK

2	Check wireharness.
----------	---------------------------

PREPARATION:

Disconnect connectors of wireless door lock tuner and Body ECU.

CHECK:

Check continuity between terminals PRG of wireless door lock tuner and PRG of Body ECU.

OK:

Continuity

NG	Repair or replace wireharness.
-----------	---------------------------------------

OK

3	Check the wireless door lock tuner.
----------	--------------------------------------------

CHECK:

Replace the wireless door lock tuner and check if it recovers normally.

OK:

Must be recovered normally.

NG	Proceed to next circuit inspection shown on problem symptoms table (See page DI-542).
-----------	----------------------------------------------------------------------------------------------

OK

Failure of the original wireless door lock tuner.

Rear Defogger Relay Circuit

WIRING DIAGRAM

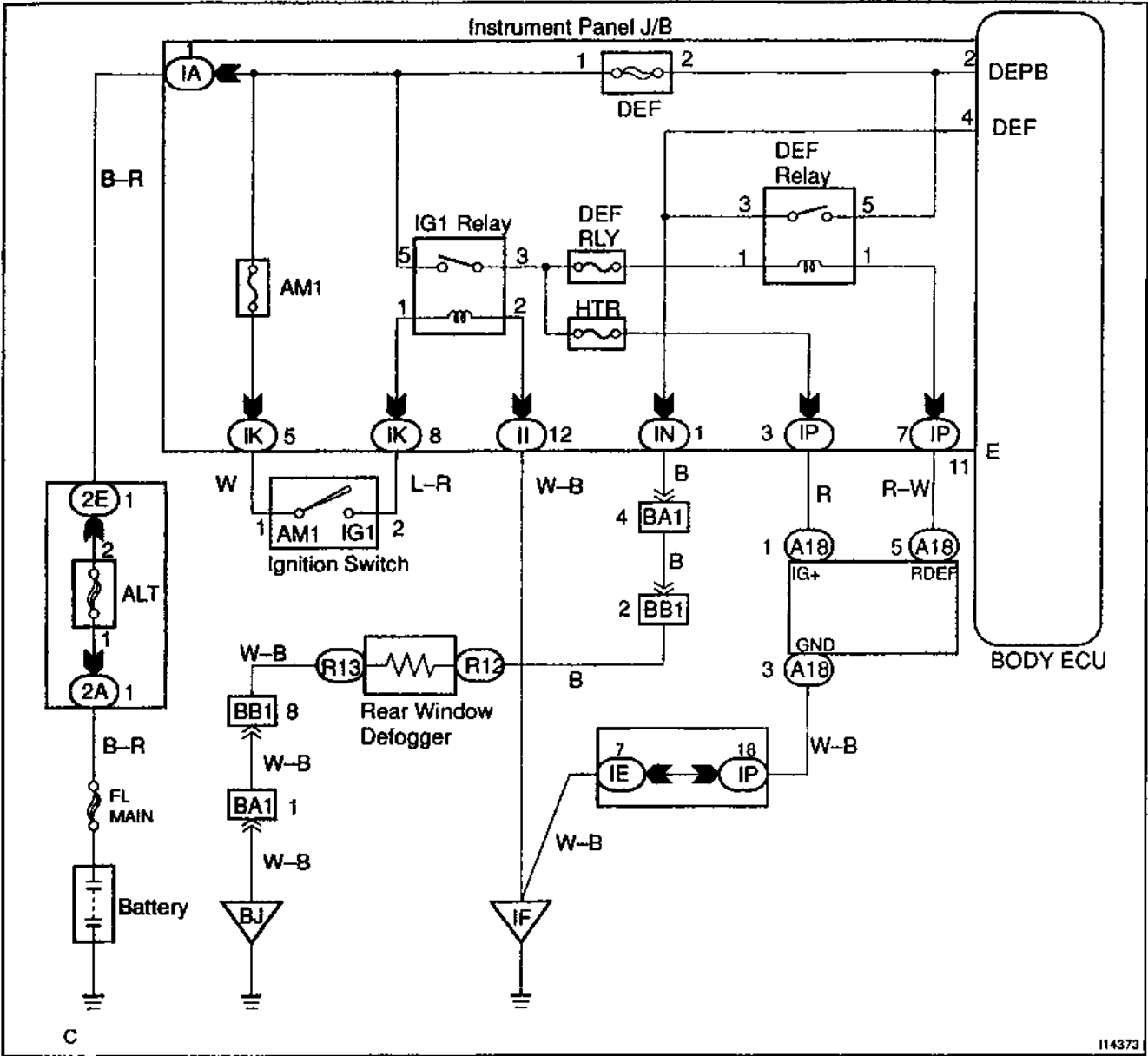

INSPECTION PROCEDURE

1	Check rear defogger relay (See page BE-55).
----------	----------------------------------------------------

NG**Replace the rear defogger relay.****OK**

2	Check wireharness and connector between rear defogger relay and body ECU, front defogger relay and body ECU (See page IN-30).
----------	--------------------------------------------------------------------------------------------------------------------------------------

NG**Repair or replace wireharness or connector.****OK**

Proceed to next circuit inspection shown on problem symptoms table (See page DI-542).

Fuel Sender Gauge Circuit

CIRCUIT DESCRIPTION

This circuit detects sensor signals from the fuel sender gauge.

WIRING DIAGRAM

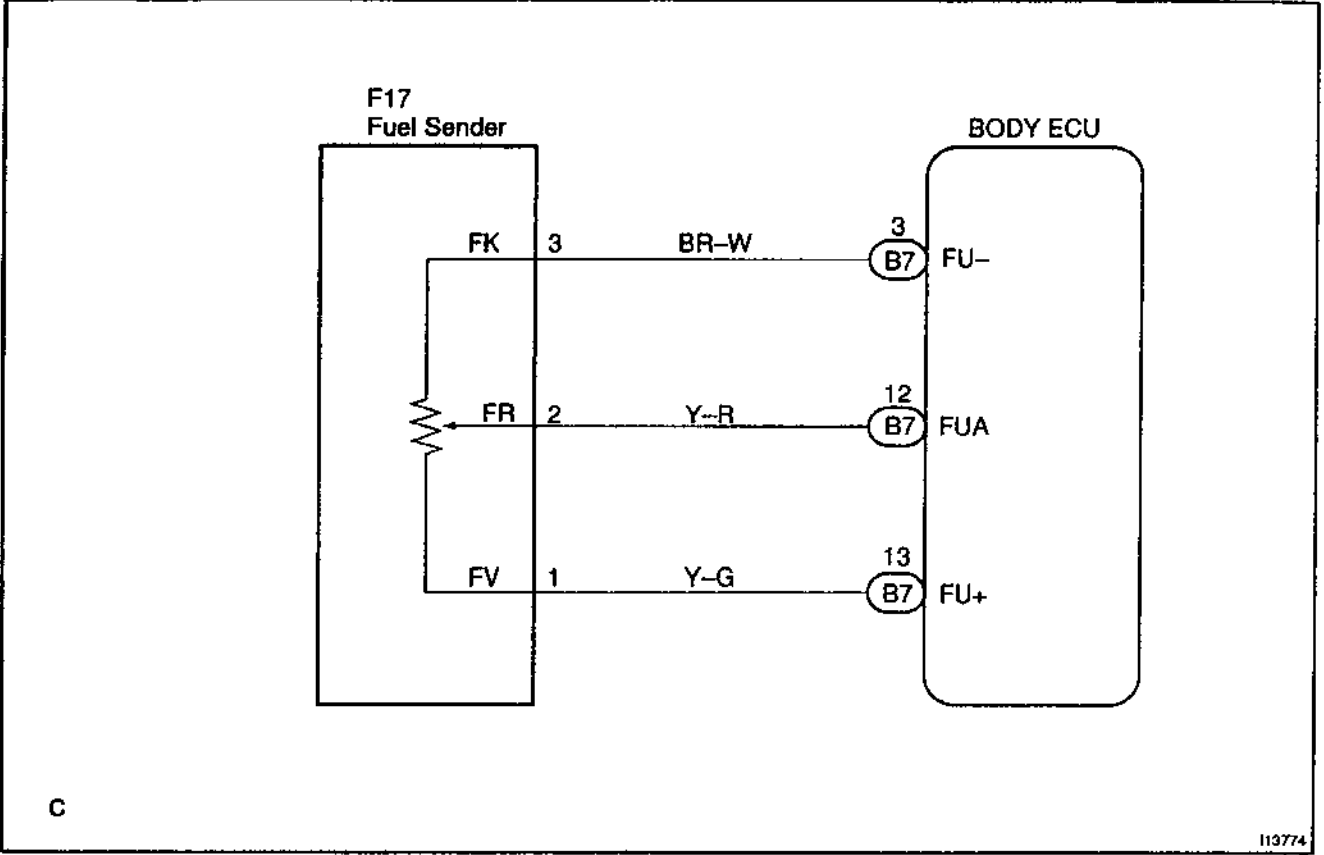

INSPECTION PROCEDURE

1 Check fuel sender gauge (See page BE-46).

NG

Replace the fuel sender gauge.

OK

2 Check wireharness and connector between fuel sender gauge and Body ECU (See page IN-30).

NG

Repair or replace wireharness or connector.

OK

Proceed to next circuit inspection shown on problem symptoms table (See page DI-542).

Brake Fluid Level Warning Switch Circuit

CIRCUIT DESCRIPTION

To detect abnormality of the brake fluid level.

WIRING DIAGRAM

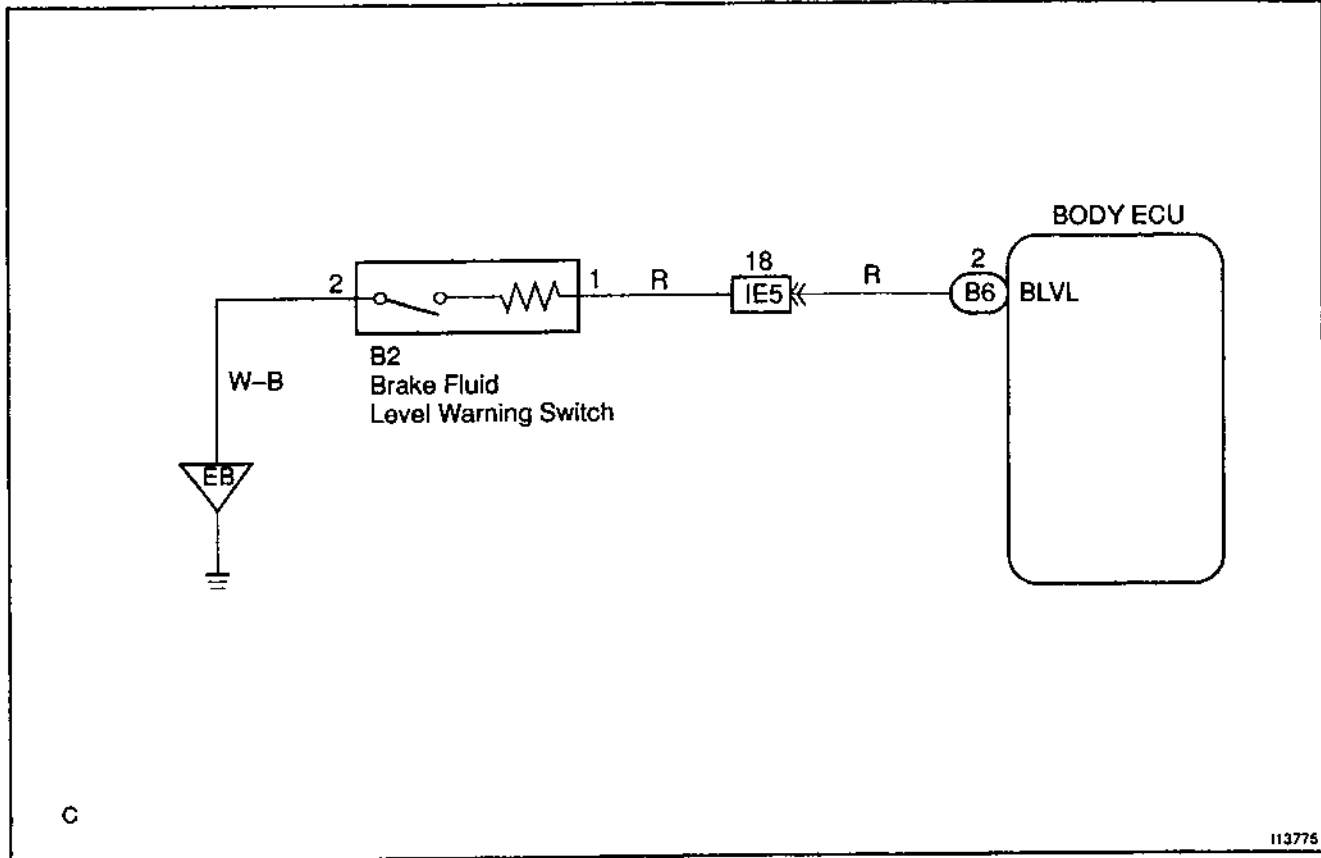

INSPECTION PROCEDURE

1 Check brake fluid level warning switch (See page BE-46).

NG

Replace the brake fluid level warning switch.

OK

2 Check wireharness and connector between brake fluid level warning switch and body ECU (See page IN-30).

NG

Repair or replace wireharness or connector.

OK

Proceed to next circuit inspection shown on problem symptoms table (See page DI-542).

Parking Brake Switch Circuit

CIRCUIT DESCRIPTION

This circuit detects the state of the parking brake switch.

WIRING DIAGRAM

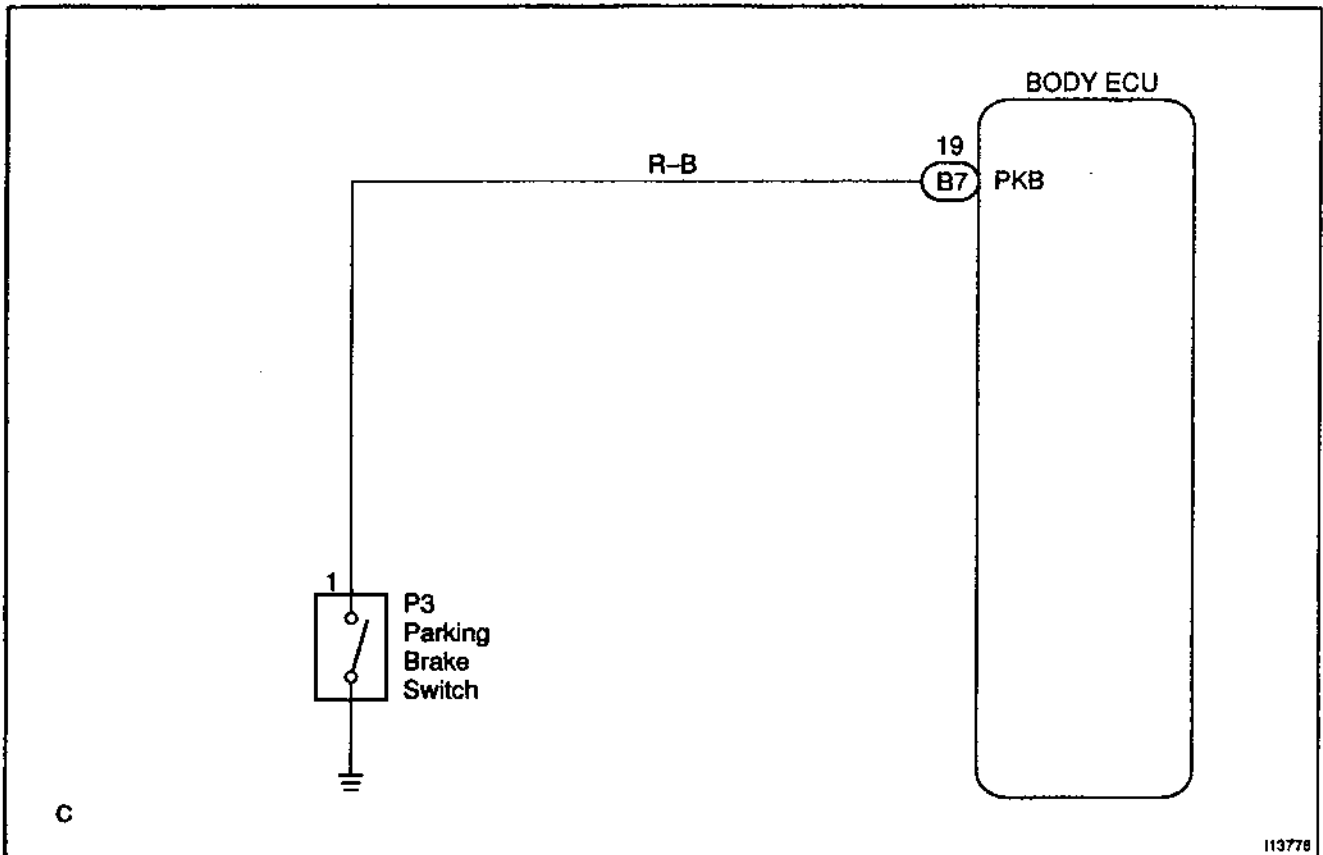

INSPECTION PROCEDURE

1	Check parking brake switch (See page BE-46).
----------	-----------------------------------------------------

NG	Replace the parking brake switch.
-----------	------------------------------------------

OK

2	Check wireharness and connector between parking brake switch and Body ECU (See page IN-30).
----------	----------------------------------------------------------------------------------------------------

NG	Repair or replace wireharness or connector.
-----------	----------------------------------------------------

OK

Proceed to next circuit inspection shown on problem symptoms table (See page DI-542).

O/D Main Switch Circuit

CIRCUIT DESCRIPTION

Body ECU detect the state O/D main switch.

WIRING DIAGRAM

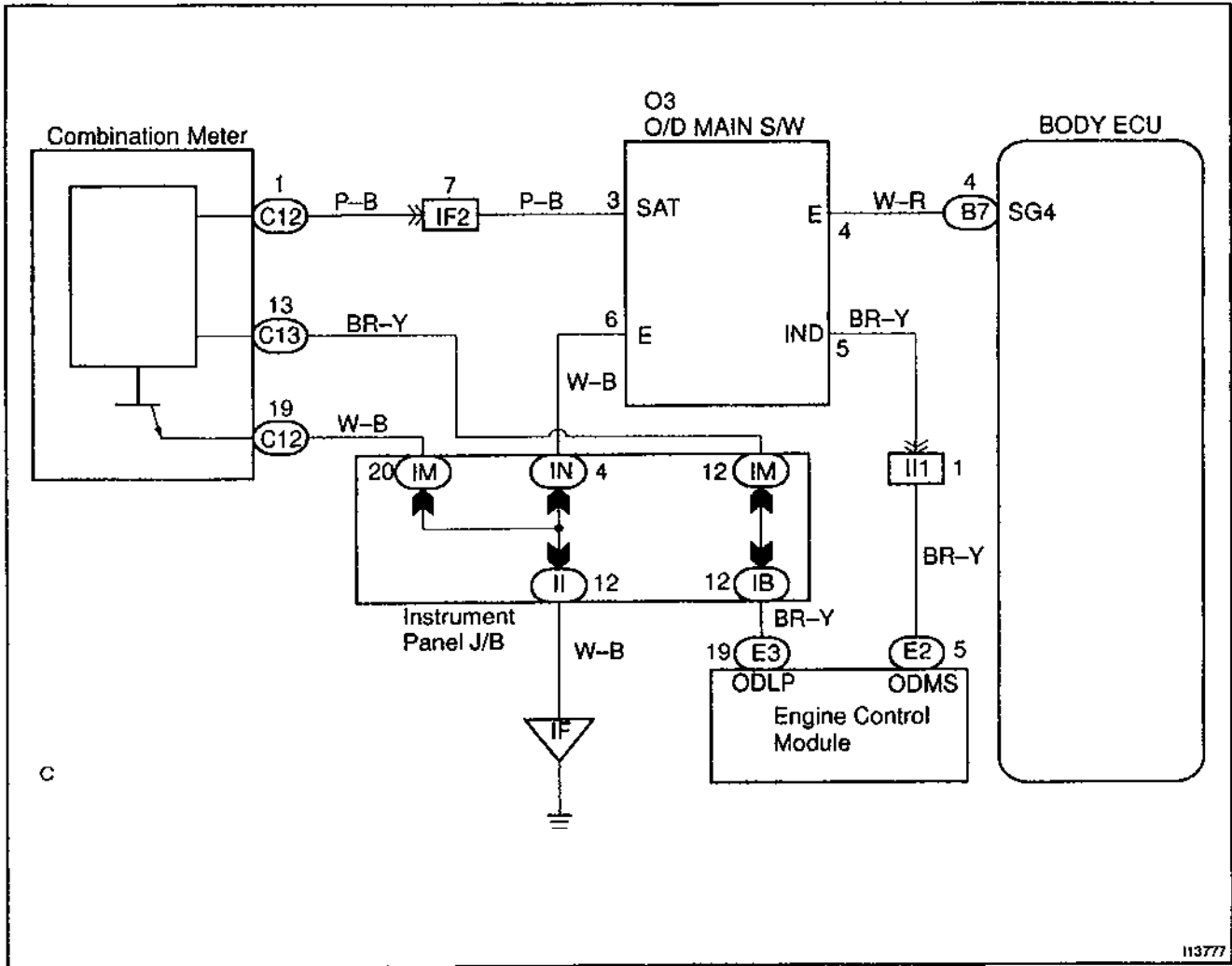

INSPECTION PROCEDURE

1	Check O/D main switch (See page DI-206, DI-268).
----------	---------------------------------------------------------

NG	Replace the O/D main switch.
-----------	-------------------------------------

OK

2	Check wireharness and connector between O/D main switch and body ECU (See page IN-30).
----------	-----------------------------------------------------------------------------------------------

NG	Repair or replace wireharness or connector.
-----------	----------------------------------------------------

OK

Proceed to next circuit inspection shown on problem symptoms table (See page DI-542).

Airbag Sensor Assembly Communication Circuit

CIRCUIT DESCRIPTION

Signals received at the body ECU, such as the passenger seat occupant detection sensor signal, is transmitted to the airbag sensor assembly.

WIRING DIAGRAM

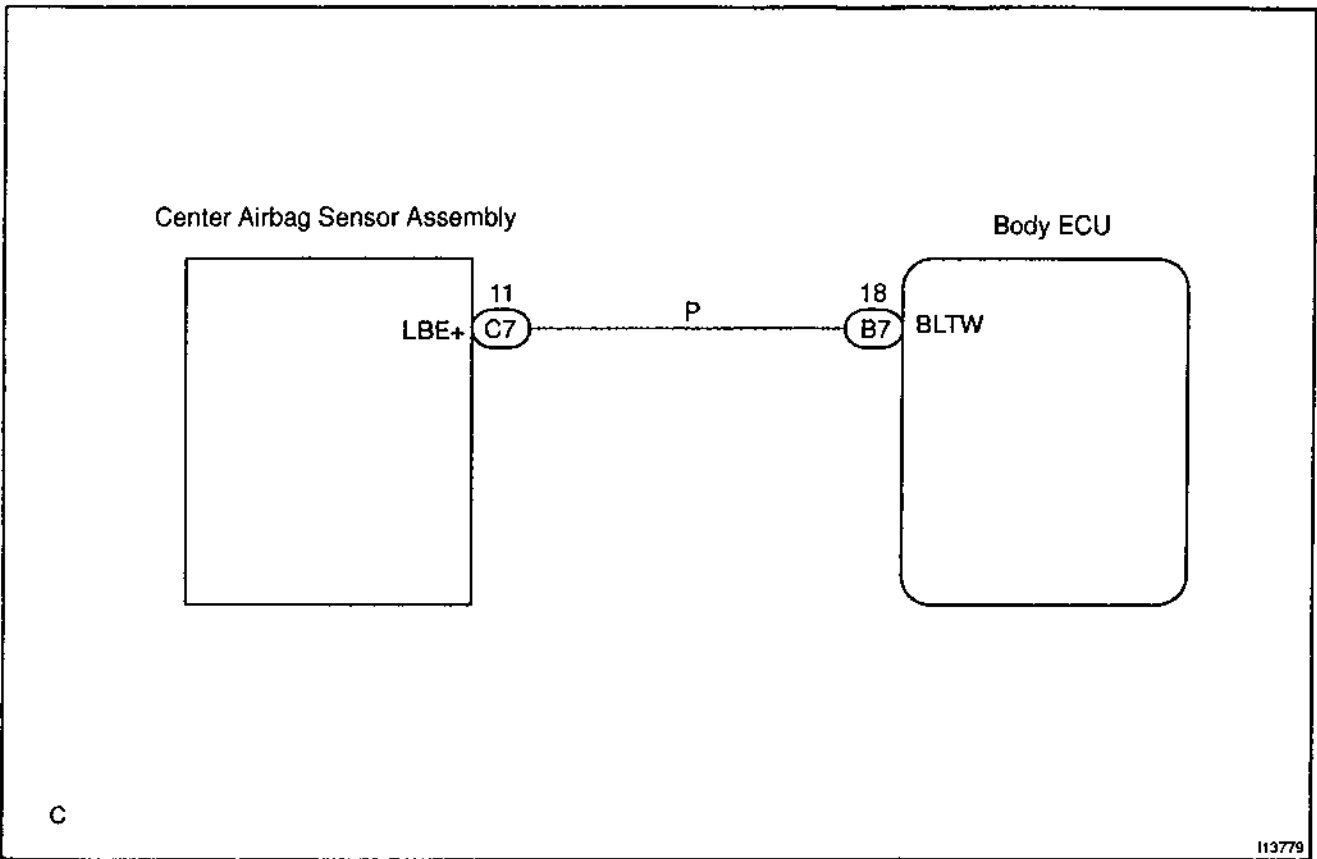

INSPECTION PROCEDURE

- | | |
|----------|----------------------------------------------------------------------------------------------------------------------------|
| 1 | Check for open and short in wireharness and connector between body ECU and airbag sensor assembly (See page IN-30). |
|----------|----------------------------------------------------------------------------------------------------------------------------|

NG**Repair or replace wireharness and connector.****OK**

- | | |
|----------|------------------------------------------------------------|
| 2 | Check the airbag sensor assembly (See page DI-324). |
|----------|------------------------------------------------------------|

NG**Replace the airbag sensor assembly.****OK****Replace the body ECU.**

Light Sensor Circuit

CIRCUIT DESCRIPTION

Signals output from the light control sensor are detected.

WIRING DIAGRAM

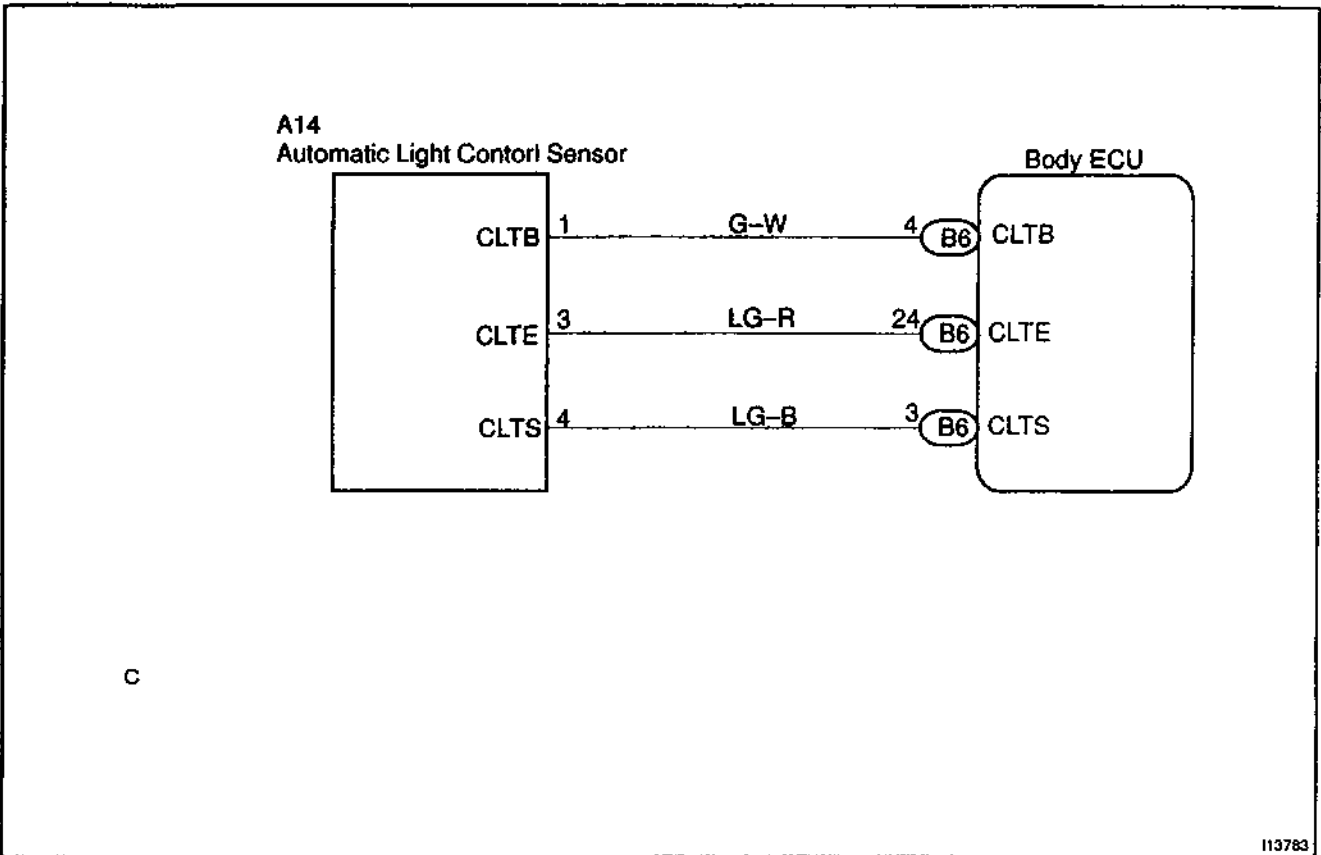

INSPECTION PROCEDURE

1 Check light sensor (See page BE-17).

NG

Replace the light sensor.

OK

2 Check wireharness and connector between light sensor and body ECU (See page IN-30).

NG

Repair or replace wireharness or connector.

OK

Replace the body ECU.

Multiplex Communication Circuit

CIRCUIT DESCRIPTION

Signals are transmitted between the ECM and combination meter through the communication circuit.

WIRING DIAGRAM

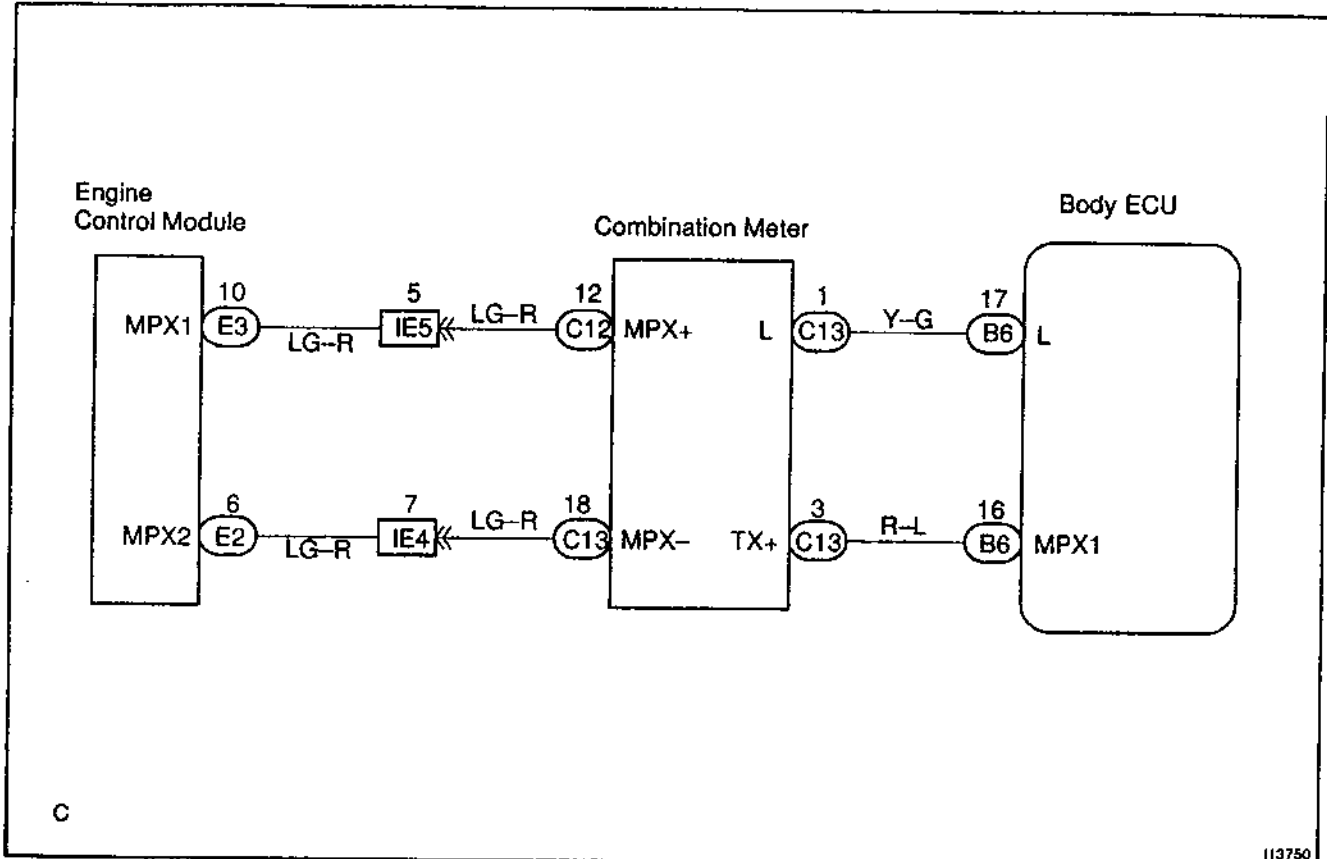

INSPECTION PROCEDURE

1	Check ECM (See page DI-1).
----------	-----------------------------------

NG

Replace the ECM.

OK

2	Check combination meter (See page BE-46).
----------	--------------------------------------------------

NG

Replace the combination meter.

OK

3	Check wireharness and connector between combination meter and body ECU, ECM and combination meter (See page IN-30).
----------	----------------------------------------------------------------------------------------------------------------------------

NG

Repair or replace wireharness or connector.

OK

Replace the body ECU.

10/10

10/10

10/10

10/10

10/10

10/10

10/10

10/10

10/10

10/10

ALPHABETICAL INDEX

A

	Page Vol.
ABBREVIATIONS USED IN THIS MANUAL (TERMS)	IN-35 (1)
ABS ACTUATOR	BR-48 (2)
AIR CONDITIONING (PREPARATION)	PP-85 (1)
AIR CONDITIONING (SERVICE SPECIFICATIONS)	SS-57 (1)
AIR CONDITIONING AMPLIFIER	AC-60 (2)
AIR CONDITIONING SYSTEM	AC-1 (2)
AIR CONDITIONING UNIT	AC-24 (2)
AIR REFINER FILTER	AC-73 (2)
AIRBAG SENSOR ASSEMBLY	RS-52 (2)
ANTENNA	BE-119 (2)
ANTI-LOCK BRAKE SYSTEM WITH ELECTRONIC BRAKE FORCE DISTRIBUTION (EBD) (DIAGNOSTICS)	DI-274 (1)
ATF TEMPERATURE SENSOR (U240E)	AX-6 (2)
ATF TEMPERATURE SENSOR (U341E)	AX-5 (2)
AUDIO SYSTEM	BE-88 (2)
AUTOMATIC TRANSAXLE (U240E) (DIAGNOSTICS)	DI-155 (1)
AUTOMATIC TRANSAXLE (U240E) (PREPARATION)	PP-46 (1)
AUTOMATIC TRANSAXLE (U240E) (SERVICE SPECIFICATIONS)	SS-41 (1)
AUTOMATIC TRANSAXLE (U341E) (DIAGNOSTICS)	DI-218 (1)
AUTOMATIC TRANSAXLE (U341E) (PREPARATION)	PP-51 (1)
AUTOMATIC TRANSAXLE (U341E) (SERVICE SPECIFICATIONS)	SS-43 (1)
AUTOMATIC TRANSAXLE SYSTEM (U240E)	AX-1 (2)
AUTOMATIC TRANSAXLE SYSTEM (U341E)	AX-1 (2)
AUTOMATIC TRANSAXLE UNIT (U240E)	AX-30 (2)
AUTOMATIC TRANSAXLE UNIT (U341E)	AX-30 (2)

B

BACK DOOR	BO-22 (2)
BACK DOOR GLASS	BO-64 (2)
BACK DOOR STAY	BO-27 (2)
BACK-UP LIGHT SYSTEM	BE-30 (2)
BLOWER MOTOR	AC-48 (2)
BLOWER RESISTOR	AC-49 (2)
BLOWER UNIT	AC-30 (2)
BODY (PREPARATION)	PP-80 (1)
BODY (SERVICE SPECIFICATIONS)	SS-55 (1)
BODY CONTROL SYSTEM (DIAGNOSTICS)	DI-535 (1)
BODY ELECTRICAL (PREPARATION)	PP-77 (1)
BODY ELECTRICAL (SERVICE SPECIFICATIONS)	SS-54 (1)
BODY ELECTRICAL SYSTEM	BE-1 (2)
BRAKE	MA-6 (1)
BRAKE (PREPARATION)	PP-62 (1)
BRAKE (SERVICE SPECIFICATIONS)	SS-49 (1)
BRAKE BOOSTER ASSEMBLY	BR-13 (2)
BRAKE FLUID	BR-4 (2)
BRAKE MASTER CYLINDER	BR-9 (2)
BRAKE PEDAL	BR-6 (2)
BRAKE SYSTEM	BR-1 (2)

C

CAMSHAFT POSITION SENSOR	IG-8 (2)
CAMSHAFT TIMING OIL CONTROL VALVE	SF-46 (2)
CHARGING (PREPARATION)	PP-24 (1)
CHARGING (SERVICE SPECIFICATIONS)	SS-27 (1)

	Page Vol.
CHARGING SYSTEM	CH-1 (2)
CHASSIS	MA-7 (1)
CIRCUIT INSPECTION (ANTI-LOCK BRAKE SYSTEM WITH ELECTRONIC BRAKE FORCE DISTRIBUTION (EBD)) (DIAGNOSTICS)	DI-285 (1)
CIRCUIT INSPECTION (AUTOMATIC TRANSAXLE (U240E)) (DIAGNOSTICS)	DI-175 (1)
CIRCUIT INSPECTION (AUTOMATIC TRANSAXLE (U341E)) (DIAGNOSTICS)	DI-238 (1)
CIRCUIT INSPECTION (BODY CONTROL SYSTEM) (DIAGNOSTICS)	DI-544 (1)
CIRCUIT INSPECTION (CRUISE CONTROL SYSTEM) (DIAGNOSTICS)	DI-496 (1)
CIRCUIT INSPECTION (ENGINE) (DIAGNOSTICS)	DI-23 (1)
CIRCUIT INSPECTION (SUPPLEMENTAL RESTRAINT SYSTEM) (DIAGNOSTICS)	DI-339 (1)
CIRCUIT OPENING RELAY	SF-53 (2)
CLIP	BO-1 (2)
CLOCK	BE-122 (2)
CLUTCH (PREPARATION)	PP-27 (1)
CLUTCH (SERVICE SPECIFICATIONS)	SS-29 (1)
CLUTCH MASTER CYLINDER	CL-4 (2)
CLUTCH PEDAL	CL-2 (2)
CLUTCH RELEASE CYLINDER	CL-9 (2)
CLUTCH UNIT	CL-14 (2)
CO/HC	EM-1 (2)
COMBINATION METER	BE-39 (2)
COMPRESSION	EM-3 (2)
COMPRESSOR AND MAGNETIC CLUTCH	AC-35 (2)
CONDENSER	AC-43 (2)
CONDENSER FAN	AC-57 (2)
COOLANT	CO-1 (2)
COOLING (PREPARATION)	PP-11 (1)
COOLING (SERVICE SPECIFICATIONS)	SS-19 (1)
COOLING FAN RELAY	AC-56 (2)
COOLING FAN RELAY	CO-31 (2)
CRANKSHAFT POSITION SENSOR	IG-11 (2)
CRUISE CONTROL SYSTEM (DIAGNOSTICS)	DI-483 (1)
CUSTOMER PROBLEM ANALYSIS CHECK (ANTI-LOCK BRAKE SYSTEM WITH ELECTRONIC BRAKE FORCE DISTRIBUTION (EBD)) (DIAGNOSTICS)	DI-275 (1)
CUSTOMER PROBLEM ANALYSIS CHECK (AUTOMATIC TRANSAXLE (U240E)) (DIAGNOSTICS)	DI-156 (1)
CUSTOMER PROBLEM ANALYSIS CHECK (AUTOMATIC TRANSAXLE (U341E)) (DIAGNOSTICS)	DI-219 (1)
CUSTOMER PROBLEM ANALYSIS CHECK (BODY CONTROL SYSTEM) (DIAGNOSTICS)	DI-536 (1)
CUSTOMER PROBLEM ANALYSIS CHECK (CRUISE CONTROL SYSTEM) (DIAGNOSTICS)	DI-484 (1)
CUSTOMER PROBLEM ANALYSIS CHECK (ENGINE) (DIAGNOSTICS)	DI-2 (1)
CUSTOMER PROBLEM ANALYSIS CHECK (SUPPLEMENTAL RESTRAINT SYSTEM) (DIAGNOSTICS)	DI-325 (1)
CYLINDER BLOCK	EM-85 (2)
CYLINDER HEAD	EM-36 (2)

D

	Page Vol.
DEFOGGER SYSTEM	BE-54 (2)
DIAGNOSTIC TROUBLE CODE CHART (ANTI-LOCK BRAKE SYSTEM WITH ELECTRONIC BRAKE FORCE DISTRIBUTION (EBD)) (DIAGNOSTICS)	DI-280 (1)
DIAGNOSTIC TROUBLE CODE CHART (AUTOMATIC TRANSAXLE (U240E)) (DIAGNOSTICS)	DI-168 (1)
DIAGNOSTIC TROUBLE CODE CHART (AUTOMATIC TRANSAXLE (U341E)) (DIAGNOSTICS)	DI-231 (1)
DIAGNOSTIC TROUBLE CODE CHART (CRUISE CONTROL SYSTEM) (DIAGNOSTICS)	DI-490 (1)
DIAGNOSTIC TROUBLE CODE CHART (ENGINE) (DIAGNOSTICS)	DI-14 (1)
DIAGNOSTIC TROUBLE CODE CHART (SUPPLEMENTAL RESTRAINT SYSTEM) (DIAGNOSTICS)	DI-332 (1)
DIFFERENTIAL CASE (C56)	MX-45 (2)
DIFFERENTIAL CASE (C60)	MX-48 (2)
DIFFERENTIAL OIL SEAL (U240E)	AX-14 (2)
DIFFERENTIAL OIL SEAL (U341E)	AX-13 (2)
DIRECT CLUTCH SPEED SENSOR (U341E)	AX-4 (2)
DOOR SIDE AIRBAG SENSOR	RS-67 (2)
DRIVE BELT	AC-16 (2)
DRIVE BELT	SR-3 (2)

E

EFI MAIN RELAY	SF-52 (2)
ELECTRIC COOLING FAN	CO-24 (2)
ELECTRIC TENSION REDUCER SYSTEM	BE-52 (2)
EMISSION CONTROL (PREPARATION)	PP-7 (1)
EMISSION CONTROL (SERVICE SPECIFICATIONS)	SS-16 (1)
EMISSION CONTROL SYSTEM	EC-1 (2)
ENGINE	MA-5 (1)
ENGINE (DIAGNOSTICS)	DI-1 (1)
ENGINE CONTROL MODULE (ECM)	SF-71 (2)
ENGINE COOLANT TEMPERATURE (ECT) SENSOR	SF-62 (2)
ENGINE COOLANT TEMPERATURE (ECT) SWITCH	AC-72 (2)
ENGINE MECHANICAL (PREPARATION)	PP-2 (1)
ENGINE MECHANICAL (SERVICE SPECIFICATIONS)	SS-6 (1)
ENGINE UNIT	EM-70 (2)
EVAPORATIVE EMISSION (EVAP) CONTROL SYSTEM	EC-5 (2)
EXHAUST SYSTEM	EM-115 (2)

F

FLOOR SHIFT ASSEMBLY (U240E)	AX-17 (2)
FLOOR SHIFT ASSEMBLY (U341E)	AX-16 (2)
FOG LIGHT SYSTEM	BE-22 (2)
FOR ALL OF VEHICLES	IN-10 (1)
FRONT AIRBAG SENSOR	RS-57 (2)
FRONT AXLE HUB	SA-11 (2)
FRONT BRAKE CALIPER	BR-20 (2)
FRONT BRAKE PAD	BR-17 (2)
FRONT BUMPER	BO-4 (2)
FRONT DOOR	BO-10 (2)
FRONT DRIVE SHAFT	SA-18 (2)
FRONT LOWER BALL JOINT	SA-46 (2)

	Page Vol.
FRONT LOWER SUSPENSION ARM	SA-41 (2)
FRONT PASSENGER AIRBAG ASSEMBLY	RS-26 (2)
FRONT SEAT	BO-92 (2)
FRONT SHOCK ABSORBER	SA-33 (2)
FRONT SPEED SENSOR	BR-55 (2)
FRONT STABILIZER BAR	SA-50 (2)
FRONT WHEEL ALIGNMENT	SA-4 (2)
FRONT WHEEL HUB BOLT	SA-17 (2)
FRONT WIPER AND WASHER	BO-28 (2)
FUEL CUT RPM	SF-73 (2)
FUEL PRESSURE REGULATOR	SF-15 (2)
FUEL PUMP	SF-6 (2)
FUEL TANK AND LINE	SF-26 (2)

G

GENERAL INFORMATION (HOW TO TROUBLESHOOT ECU CONTROLLED SYSTEMS)	IN-19 (1)
GENERAL INFORMATION (HOW TO USE THIS MANUAL)	IN-1 (1)
GENERAL INFORMATION (REPAIR INSTRUCTIONS)	IN-4 (1)
GENERATOR	CH-5 (2)
GLOSSARY OF SAE AND TOYOTA TERMS (TERMS)	IN-40 (1)

H

HEADLIGHT	BO-6 (2)
HEADLIGHT AND TAILLIGHT SYSTEM	BE-15 (2)
HEATED OXYGEN SENSOR	SF-69 (2)
HEATER CONTROL ASSEMBLY	AC-65 (2)
HEATER MAIN RELAY	AC-54 (2)
HOOD	BO-9 (2)
HORN SYSTEM	BE-125 (2)
HOW TO PROCEED WITH TROUBLESHOOTING (ANTI-LOCK BRAKE SYSTEM WITH ELECTRONIC BRAKE FORCE DISTRIBUTION (EBD)) (DIAGNOSTICS)	DI-274 (1)
HOW TO PROCEED WITH TROUBLESHOOTING (AUTOMATIC TRANSAXLE (U240E)) (DIAGNOSTICS)	DI-155 (1)
HOW TO PROCEED WITH TROUBLESHOOTING (AUTOMATIC TRANSAXLE (U341E)) (DIAGNOSTICS)	DI-218 (1)
HOW TO PROCEED WITH TROUBLESHOOTING (BODY CONTROL SYSTEM) (DIAGNOSTICS)	DI-535 (1)
HOW TO PROCEED WITH TROUBLESHOOTING (CRUISE CONTROL SYSTEM) (DIAGNOSTICS)	DI-483 (1)
HOW TO PROCEED WITH TROUBLESHOOTING (ENGINE) (DIAGNOSTICS)	DI-1 (1)
HOW TO PROCEED WITH TROUBLESHOOTING (HOW TO TROUBLESHOOT ECU CONTROLLED SYSTEMS)	IN-20 (1)
HOW TO PROCEED WITH TROUBLESHOOTING (SUPPLEMENTAL RESTRAINT SYSTEM) (DIAGNOSTICS)	DI-324 (1)
HOW TO TROUBLESHOOT ECU CONTROLLED SYSTEMS	IN-19 (1)
HOW TO USE THE DIAGNOSTIC CHART AND INSPECTION PROCEDURE (HOW TO TROUBLESHOOT ECU CONTROLLED SYSTEMS)	IN-30 (1)
HOW TO USE THIS MANUAL	IN-1 (1)

I

	Page Vol.
IDENTIFICATION INFORMATION	IN-3 (1)
IDLE AIR CONTROL (IAC) VALVE	SF-40 (2)
IDLE SPEED	EM-14 (2)
IGNITION (PREPARATION)	PP-19 (1)
IGNITION (SERVICE SPECIFICATIONS)	SS-23 (1)
IGNITION COIL	IG-5 (2)
IGNITION SWITCH AND KEY UNLOCK WARNING SWITCH	BE-13 (2)
IGNITION SYSTEM	IG-1 (2)
IGNITION TIMING	EM-13 (2)
INJECTOR	SF-18 (2)
INPUT SHAFT (C56)	MX-26 (2)
INPUT SHAFT (C60)	MX-29 (2)
INSIDE VEHICLE	MA-2 (1)
INSTRUMENT PANEL	BO-76 (2)
INTERIOR LIGHT SYSTEM	BE-27 (2)

K

KNOCK SENSOR	SF-66 (2)
--------------------	-----------

L

LUBRICATION (PREPARATION)	PP-15 (1)
LUBRICATION (SERVICE SPECIFICATIONS)	SS-21 (1)

M

MAGNETIC CLUTCH RELAY	AC-55 (2)
MAINTENANCE (PREPARATION)	PP-1 (1)
MAINTENANCE (SERVICE SPECIFICATIONS)	SS-4 (1)
MANIFOLD GAUGE SET	AC-19 (2)
MANUAL TRANSAXLE (C56) (PREPARATION)	PP-31 (1)
MANUAL TRANSAXLE (C56) (SERVICE SPECIFICATIONS)	SS-31 (1)
MANUAL TRANSAXLE (C60) (PREPARATION)	PP-38 (1)
MANUAL TRANSAXLE (C60) (SERVICE SPECIFICATIONS)	SS-36 (1)
MANUAL TRANSAXLE ASSEMBLY (C56)	MX-9 (2)
MANUAL TRANSAXLE ASSEMBLY (C60)	MX-9 (2)
MANUAL TRANSAXLE UNIT (C56)	MX-2 (2)
MANUAL TRANSAXLE UNIT (C60)	MX-2 (2)
MASS AIR FLOW (MAF) METER	SF-29 (2)

O

OIL AND FILTER	LU-1 (2)
OIL NOZZLE (2ZZ-GE)	LU-14 (2)
OIL PUMP	LU-5 (2)
OUTPUT SHAFT (C56)	MX-34 (2)
OUTPUT SHAFT (C60)	MX-37 (2)
OUTSIDE VEHICLE	MA-1 (1)

P

PARK/NEUTRAL POSITION (PNP) SWITCH (U240E)	AX-8 (2)
PARK/NEUTRAL POSITION (PNP) SWITCH (U341E)	AX-7 (2)
PARKING BRAKE	BR-42 (2)
PARKING BRAKE LEVER	BR-8 (2)
PARTS LAYOUT AND SCHEMATIC DRAWING	EC-2 (2)

PARTS LOCATION (ANTI-LOCK BRAKE SYSTEM WITH ELECTRONIC BRAKE FORCE DISTRIBUTION (EBD)) (DIAGNOSTICS)	DI-281 (1)
PARTS LOCATION (AUTOMATIC TRANSAXLE (U240E)) (DIAGNOSTICS)	DI-169 (1)
PARTS LOCATION (AUTOMATIC TRANSAXLE (U341E)) (DIAGNOSTICS)	DI-232 (1)
PARTS LOCATION (BODY CONTROL SYSTEM) (DIAGNOSTICS)	DI-537 (1)
PARTS LOCATION (CRUISE CONTROL SYSTEM) (DIAGNOSTICS)	DI-491 (1)
PARTS LOCATION (ENGINE) (DIAGNOSTICS)	DI-19 (1)
PARTS LOCATION (SUPPLEMENTAL RESTRAINT SYSTEM) (DIAGNOSTICS)	DI-335 (1)
POSITIVE CRANKCASE VENTILATION (PCV) SYSTEM	EC-4 (2)
POWER DOOR LOCK CONTROL SYSTEM	BE-62 (2)
POWER MIRROR CONTROL SYSTEM	BE-85 (2)
POWER SOURCE	BE-10 (2)
POWER STEERING FLUID	SR-4 (2)
POWER STEERING GEAR	SR-33 (2)
POWER STEERING VANE PUMP	SR-22 (2)
POWER WINDOW CONTROL SYSTEM	BE-58 (2)
PRE-CHECK (ANTI-LOCK BRAKE SYSTEM WITH ELECTRONIC BRAKE FORCE DISTRIBUTION (EBD)) (DIAGNOSTICS)	DI-276 (1)
PRE-CHECK (AUTOMATIC TRANSAXLE (U240E)) (DIAGNOSTICS)	DI-157 (1)
PRE-CHECK (AUTOMATIC TRANSAXLE (U341E)) (DIAGNOSTICS)	DI-220 (1)
PRE-CHECK (CRUISE CONTROL SYSTEM) (DIAGNOSTICS)	DI-485 (1)
PRE-CHECK (ENGINE) (DIAGNOSTICS)	DI-3 (1)
PRE-CHECK (SUPPLEMENTAL RESTRAINT SYSTEM) (DIAGNOSTICS)	DI-326 (1)
PRECAUTION (FOR ALL OF VEHICLES)	IN-10 (1)
PRESSURE SWITCH	AC-51 (2)
PROBLEM SYMPTOMS TABLE (ANTI-LOCK BRAKE SYSTEM WITH ELECTRONIC BRAKE FORCE DISTRIBUTION (EBD)) (DIAGNOSTICS)	DI-284 (1)
PROBLEM SYMPTOMS TABLE (AUTOMATIC TRANSAXLE (U240E)) (DIAGNOSTICS)	DI-172 (1)
PROBLEM SYMPTOMS TABLE (AUTOMATIC TRANSAXLE (U341E)) (DIAGNOSTICS)	DI-234 (1)
PROBLEM SYMPTOMS TABLE (BODY CONTROL SYSTEM) (DIAGNOSTICS)	DI-542 (1)
PROBLEM SYMPTOMS TABLE (CRUISE CONTROL SYSTEM) (DIAGNOSTICS)	DI-494 (1)
PROBLEM SYMPTOMS TABLE (ENGINE) (DIAGNOSTICS)	DI-22 (1)
PROBLEM SYMPTOMS TABLE (SUPPLEMENTAL RESTRAINT SYSTEM) (DIAGNOSTICS)	DI-338 (1)
PROPORTIONING VALVE (P VALVE)	BR-47 (2)

Q

	Page Vol.
QUARTER WINDOW GLASS	BO-55 (2)

R

RADIATOR	CO-12 (2)
REAR AXLE CARRIER	SA-54 (2)
REAR BRAKE CALIPER	BR-36 (2)
REAR BRAKE PAD	BR-33 (2)
REAR BUMPER	BO-5 (2)
REAR DRUM BRAKE	BR-28 (2)
REAR LOWER SUSPENSION ARM	SA-71 (2)
REAR SEAT	BO-101 (2)
REAR SHOCK ABSORBER	SA-61 (2)
REAR SPEED SENSOR	BR-58 (2)
REAR STABILIZER BAR	SA-75 (2)
REAR UPPER SUSPENSION ARM	SA-68 (2)
REAR WHEEL ALIGNMENT	SA-8 (2)
REAR WHEEL HUB BOLT	SA-60 (2)
REAR WIPER AND WASHER	BO-33 (2)
REFRIGERANT LINE	AC-21 (2)
REPAIR INSTRUCTIONS	IN-4 (1)
REVERSE SHIFT WARNING BUZZER SYSTEM (C60)	MX-55 (2)
ROOF DRIP SIDE MOULDING	BO-38 (2)
ROOF HEADLINING	BO-86 (2)
ROOF SIDE MOULDING	BO-42 (2)

S

SEAT BELT	BO-106 (2)
SEAT BELT PRETENSIONER	BO-109 (2)
SFI (PREPARATION)	PP-8 (1)
SFI (SERVICE SPECIFICATIONS)	SS-17 (1)
SFI SYSTEM	SF-1 (2)
SHIFT AND SELECT LEVER SHAFT (C56)	MX-44 (2)
SHIFT AND SELECT LEVER SHAFT (C60)	MX-47 (2)
SHIFT LEVER AND CONTROL CABLE (C56)	MX-52 (2)
SHIFT LEVER AND CONTROL CABLE (C60)	MX-57 (2)
SHIFT LOCK SYSTEM (U240E)	AX-15 (2)
SHIFT LOCK SYSTEM (U341E)	AX-14 (2)
SIDE AIRBAG ASSEMBLY	RS-39 (2)
SIDE AIRBAG SENSOR ASSEMBLY	RS-62 (2)
SIDE MUD GUARD	BO-46 (2)
SLIDING ROOF	BO-69 (2)
SLIDING ROOF SYSTEM	BE-82 (2)
SPEED SENSOR (U240E)	AX-4 (2)
SRS AIRBAG	BO-3 (2)
SRS AIRBAG	RS-1 (2)
STANDARD BOLT (SERVICE SPECIFICATIONS)	SS-1 (1)
STARTER	ST-2 (2)
STARTER RELAY	ST-17 (2)
STARTING (PREPARATION)	PP-21 (1)
STARTING (SERVICE SPECIFICATIONS)	SS-25 (1)
STARTING SYSTEM	ST-1 (2)
STEERING (PREPARATION)	PP-67 (1)
STEERING (SERVICE SPECIFICATIONS)	SS-51 (1)
STEERING SYSTEM	SR-1 (2)
STEERING WHEEL	SR-8 (2)
STEERING WHEEL PAD AND SPIRAL CABLE	RS-12 (2)
STOP LIGHT SYSTEM	BE-32 (2)
SUPPLEMENTAL RESTRAINT SYSTEM (DIAGNOSTICS)	DI-324 (1)
SUPPLEMENTAL RESTRAINT SYSTEM (PREPARATION)	PP-74 (1)
SUPPLEMENTAL RESTRAINT SYSTEM (SERVICE SPECIFICATIONS)	SS-53 (1)

Page Vol.

SUSPENSION AND AXLE (PREPARATION)	PP-56 (1)
SUSPENSION AND AXLE (SERVICE SPECIFICATIONS)	SS-45 (1)

T

TERMINALS OF ECM (AUTOMATIC TRANSAXLE (U240E)) (DIAGNOSTICS)	DI-170 (1)
TERMINALS OF ECM (AUTOMATIC TRANSAXLE (U341E)) (DIAGNOSTICS)	DI-233 (1)
TERMINALS OF ECM (ENGINE) (DIAGNOSTICS)	DI-20 (1)
TERMINALS OF ECU (ANTI-LOCK BRAKE SYSTEM WITH ELECTRONIC BRAKE FORCE DISTRIBUTION (EBD)) (DIAGNOSTICS)	DI-282 (1)
TERMINALS OF ECU (BODY CONTROL SYSTEM) (DIAGNOSTICS)	DI-539 (1)
TERMINALS OF ECU (CRUISE CONTROL SYSTEM) (DIAGNOSTICS)	DI-492 (1)
TERMINALS OF ECU (SUPPLEMENTAL RESTRAINT SYSTEM) (DIAGNOSTICS)	DI-336 (1)
TERMS	IN-35 (1)
THERMISTOR	AC-50 (2)
THERMOSTAT	CO-8 (2)
THREE-WAY CATALYTIC CONVERTER (TWC) SYSTEM	EC-11 (2)
THROTTLE BODY	SF-33 (2)
TILT STEERING COLUMN	SR-9 (2)
TIMING CHAIN	EM-15 (2)
TIRE AND WHEEL	SA-2 (2)
TORQUE CONVERTER CLUTCH AND DRIVE PLATE (U240E)	AX-36 (2)
TORQUE CONVERTER CLUTCH AND DRIVE PLATE (U341E)	AX-36 (2)
TROUBLESHOOTING	AC-14 (2)
TROUBLESHOOTING	BE-2 (2)
TROUBLESHOOTING	BR-2 (2)
TROUBLESHOOTING	CL-1 (2)
TROUBLESHOOTING	SA-1 (2)
TROUBLESHOOTING	SR-2 (2)
TROUBLESHOOTING (C56)	MX-2 (2)
TROUBLESHOOTING (C60)	MX-1 (2)
TURN SIGNAL AND HAZARD WARNING SYSTEM	BE-25 (2)

U

UNDER HOOD	MA-4 (1)
------------------	----------

V

VALVE BODY ASSEMBLY (U240E)	AX-10 (2)
VALVE BODY ASSEMBLY (U341E)	AX-9 (2)
VALVE CLEARANCE	EM-4 (2)
VAPOR PRESSURE SENSOR	SF-64 (2)
VEHICLE IDENTIFICATION AND ENGINE SERIAL NUMBER (IDENTIFICATION INFORMATION)	IN-3 (1)
VEHICLE LIFT AND SUPPORT LOCATIONS (REPAIR INSTRUCTIONS)	IN-8 (1)
VEHICLE SPEED SENSOR (U240E)	AX-3 (2)
VEHICLE SPEED SENSOR (U341E)	AX-3 (2)
VSV FOR CANISTER CLOSED VALVE (CCV)	SF-58 (2)
VSV FOR EVAPORATIVE EMISSION (EVAP)	SF-56 (2)
VSV FOR INTAKE AIR CONTROL VALVE	SF-54 (2)
VSV FOR PRESSURE SWITCHING VALVE	SF-60 (2)

W

	Page	Vol.
WATER PUMP	CO-4	(2)
WINDSHIELD	BO-47	(2)
WIPER AND WASHER SYSTEM	BE-34	(2)
WIRE HARNESS AND CONNECTOR	RS-72	(2)
WIRELESS DOOR LOCK CONTROL SYSTEM	BE-67	(2)

